

# Popular Electronics®

WORLD'S LARGEST-SELLING ELECTRONICS MAGAZINE AUGUST 1977 / \$1.25

- **HOW TO AVOID STATIC DAMAGE TO MOS DEVICES**
- **BUILD A CAMERA SHUTTER-SPEED TESTER**
- **NEW COMMUNICATION BAND FOR "KIDDIE-TALKIES"**
- **ADD DIGITAL CLOCK/TIMER FUNCTION TO SIMPLE CALCULATORS**
- **SOFTWARE FOR THE TVT-6 VIDEO DISPLAY**
- **TESTED IN THIS ISSUE:** Heath AR-1515 Digital Readout Stereo FM/AM Receiver ■ Thorens TD-126C Turntable ■ President "Washington" 40-Channel Base Station

## BUILD THE "CABONGA" ELECTRONIC PERCUSSION SYNTHESIZER

Simulates percussive instruments from bass drum to wood block



303196 DRK 6450M090 1410 NOV79  
L DARKNELL JR  
6450 HYRLEWOOD DR  
SAN JOSE CA 95129



Introducing the mobile that can move you out of the world of the ordinary and into the world of the serious CB'er. The Cobra 138XLR Single Sideband. Sidebanding puts you in your own private world. A world where there's less congestion. More privacy. More time to talk.



It's all possible because instead of 40 channels you get your choice of 120 channels. Both AM and SSB. And instead of 4 watts of legal power you get 12 watts of legal power. So you get almost double the range of AM.

With the 138XLR Single Sideband there's less background noise and less interference. So there's cleaner, clearer reception. Because like all Cobras, the 138XLR SSB is engineered to punch through loud and clear. Even in crowded metropolitan areas.

And like all Cobras it comes equipped with such standard features as an easy-to-read LED channel indicator. Switchable noise blanking and limiting. An RF/signal strength meter. And Cobra's exclusive DynaMike gain control.

You'll find the 138XLR SSB wherever Cobras are sold. Which is almost everywhere. Because Cobra's got a nationwide network of dealers and Authorized Service Centers offering sales, installation, service and advice. So come on in. And move on up.



**Punches through loud and clear.**

Cobra Communications Products  
**DYNASCAN CORPORATION**  
 6460 W. Cortland St., Chicago, Illinois 60635

Write for color brochure  
 EXPORTERS: Empire • Plainview, N.Y. • CANADA: Atlas Electronics • Toronto

CIRCLE NO. 12 ON FREE INFORMATION CARD

# UPWARD MOBILITY.



# new grounds to buy Ungar

New OSHA®  
#750 Three-Wire  
Grounded Handle  
is easy to use,  
lightweight and  
biomechanically  
designed to remain  
cool and  
comfortable during  
continuous use.

Unique,  
spring-loaded heat  
reflecting ground  
plate eliminates  
electrostatic tip  
potential.

Ungar's new "3"  
and "HP" steel,  
thread-together  
heaters taper-fit  
firmly into the  
handle and are  
available in several  
wattages and types.  
1. For thread-on  
Standard Line tips.  
2. Integral heater/ tips.

The new load-  
modulated "HP"  
High Performance  
Series Heaters  
respond  
automatically to  
temperature  
changes and  
provide the capacity  
of much larger irons.

Heat resistant,  
three-wire, flexible  
cord and NEMA  
plug assure long  
life, easy handling  
and a positive  
ground from tip to  
plug.



Division of Eldon Industries, Inc. / 233 East Manville / Compton, CA 90220 / 213 774-5950



# WHY THE FIRST HIGH POWERED RECEIVER IS STILL THE BEST HIGH POWERED RECEIVER.

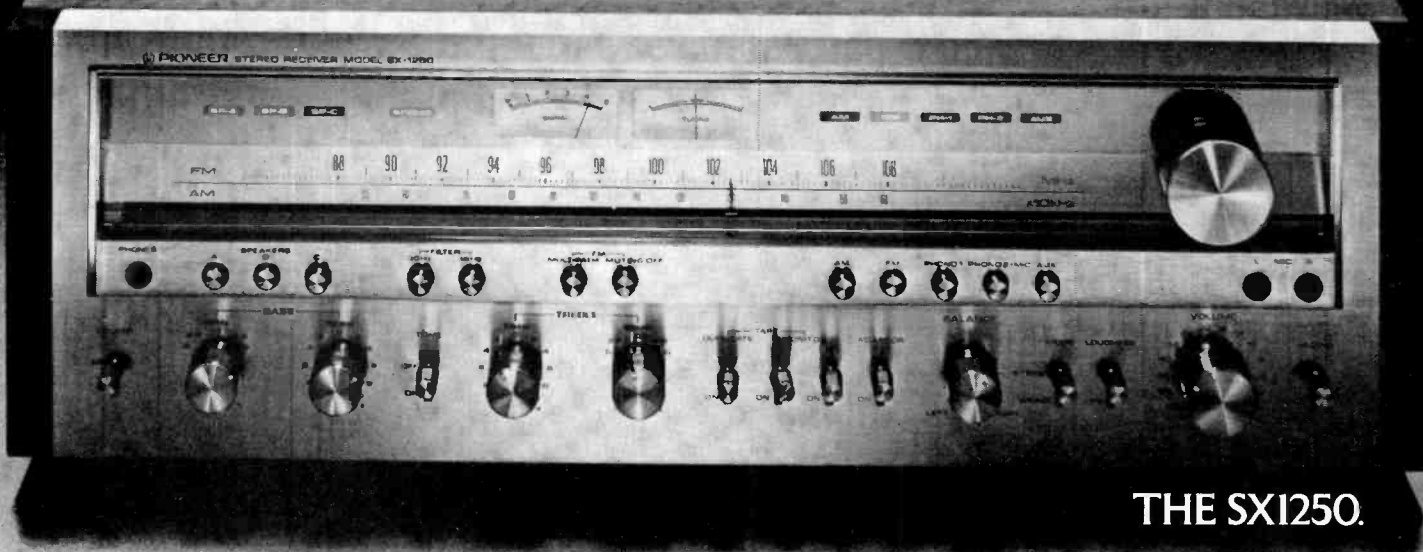

THE SX1250.

## WHEN YOU'RE NOT IN A RUSH TO CATCH UP YOU'VE GOT THE TIME TO BUILD THINGS RIGHT.

When Pioneer first introduced the 160 watt\* SX 1250 last year, it prompted our competitors to hastily introduce a bevy of high powered receivers.

Unlike the others, however, the SX 1250 wasn't a rush job. And the time and care that went into it can both be seen and heard.

Inside the SX 1250, for example, you'll find that we took the time to shield every critical section. So spurious signals from one section can't leak into another. And dirt and dust can't get in to affect performance. So the SX 1250 not only produces



An extraordinary power supply, for an extraordinary amount of power.

crisp, interference-free sound when it's new, but still sounds great as it grows old.

In our power supply, instead of finding a conventional transformer, you'll find a heavier, more advanced toroidal-core transformer. It's

less susceptible to voltage variations. And less likely to leak noise. Which means you get a cleaner, clearer sound.

And where most high powered receivers come with a three, or four gang variable capacitor for FM tuning, the SX 1250 features a *five* gang zinc plated variable capacitor that cleans up FM reception much better. And helps to pull in stations that some three or four gang capacitors can't even touch.

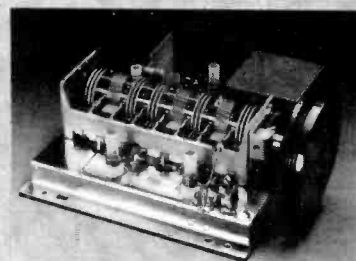

A five gang variable capacitor for FM reception that never varies.

Obviously, these are only a few of the refinements that went into the SX 1250. But given just these few things, it should come as no surprise that the SX 1250 even weighs more than most of our competitors' high powered offerings.

So before you run out and buy just any high powered receiver, consider all the time and engineering that went into the SX 1250. And weigh your decision carefully.

High Fidelity Components  
**PIONEER**  
WE BRING IT BACK ALIVE.

©1977 U.S. Pioneer Electronics, 85 Oxford Drive, Moonachie, New Jersey 07074

\*160 watts per channel minimum RMS continuous power output at 8 ohms, from 20 to 20,000 Hz, with no more than 0.1% total harmonic distortion.

CIRCLE NO. 58 ON FREE INFORMATION CARD



# Popular Electronics®

WORLD'S LARGEST-SELLING ELECTRONICS MAGAZINE

## FEATURE ARTICLES

IS THERE A DIGITAL FM TUNER? .....	Julian D. Hirsch	28
CHOOSING PORTABLE AND MOBILE TAPE RECORDERS .....	James R. Horstman	43
<i>Tape enthusiasts need not be tied to a wall socket.</i>		
NEW BAND FOR "KIDDIE-TALKIES" .....	Leo Sands	46
<i>100-mW portable two-way radios are moving out of the CB band.</i>		
TTL LOGIC QUIZ .....	Robert P. Balin	58
HOW TO HANDLE MOS DEVICES WITHOUT DESTROYING THEM .....	Leslie Solomon	67

## CONSTRUCTION ARTICLES

BUILD "CABONGA" PART I .....	James Barbarello	39
<i>An electronic percussion synthesizer.</i>		
SHUT-OFF TIMER FOR BATTERY-POWERED APPLIANCES .....	Jeffrey Sandler	48
BUILD THE TVT-6 PART II .....	Don Lancaster	49
<i>System debugging, software, and how to interface to other processors.</i>		
MORE ON USING CALCULATORS AS STOPCLOCKS		
HOW TO CONVERT A "FOUR BANGER" FOR STOPWATCH FUNCTIONS .....	Charles Stanford	56
THE HP-25 AS A DIGITAL CLOCK & TIMER .....	William T. Peters	57
BUILD A DIGITAL CAMERA SHUTTER TIMER .....	R. S. Hedin	59
<i>Provides accurate check of shutter speeds from 1/1000 to 1 second.</i>		

## COLUMNS

STEREO SCENE .....	Ralph Hodges	14
<i>Tape Topics.</i>		
SOLID STATE .....	Lou Garner	71
<i>A Circuit Medley.</i>		
HOBBY SCENE Q & A .....	John McVeigh	77
EXPERIMENTER'S CORNER .....	Forrest M. Mims	82
<i>The Four-Layer Diode.</i>		
CB SCENE .....	Ray Newhall	90
<i>CB Development News and Views.</i>		
COMPUTER BITS .....	Leslie Solomon	88
<i>Remote Control.</i>		

## JULIAN HIRSCH AUDIO REPORTS

HEATH MODEL AR-1515 AM/STEREO FM RECEIVER .....	29
THORENS MODEL TD-126C RECORD PLAYER .....	32
ORTOFON MODEL MC20 PHONO CARTRIDGE AND MODEL MCA-76 PREAMPLIFIER .....	34

## ELECTRONIC PRODUCT TEST REPORTS

PRESIDENT "WASHINGTON" AM/SSB CB BASE STATION .....	84
FLUKE MODEL 8020A DIGITAL MULTIMETER .....	85

## DEPARTMENTS

EDITORIAL .....	Art Salsberg	4
<i>Elitism Finely Drawn.</i>		
LETTERS .....		6
NEW PRODUCTS .....		8
NEW LITERATURE .....		12

POPULAR ELECTRONICS, August 1977, Volume 12, Number 2. Published monthly at One Park Avenue, New York, NY 10016. One year subscription rate for U.S. and Possessions, \$12.00; Canada, \$15.00; all other countries, \$17.00 (cash orders only, payable in U.S. currency). Second Class postage paid at New York, NY and at additional mailing offices. Authorized as second class mail by the Post Office Department, Ottawa, Canada, and for payment of postage in cash.

POPULAR ELECTRONICS including ELECTRONICS WORLD, Trade Mark Registered, Indexed in the Reader's Guide to Periodical Literature.

COPYRIGHT © 1977 BY ZIFF-DAVIS PUBLISHING COMPANY. ALL RIGHTS RESERVED.

Ziff-Davis also publishes Boating, Car and Driver, Cycle, Flying, Modern Bride, Popular Photography, Skiing and Stereo Review.

Material in this publication may not be reproduced in any form without permission. Requests for permission should be directed to Jerry Schneider, Rights and Permissions, Ziff-Davis Publishing Co., One Park Ave., New York, NY 10016.

Editorial correspondence: POPULAR ELECTRONICS, 1 Park Ave., New York, NY 10016. Editorial contributions must be accompanied by return postage and will be handled with reasonable care; however, publisher assumes no responsibility for return or safety of manuscripts, art work, or models.

Forms 3579 and all subscription correspondence: POPULAR ELECTRONICS, Circulation Dept., P.O. Box 2774, Boulder, CO 80302. Please allow at least eight weeks for change of address. Include your old address, enclosing, if possible, an address label from a recent issue.



**JOSEPH E. MESICS**  
Publisher

**ARTHUR P. SALSBERG**  
Editorial Director

**LESLIE SOLOMON**  
Technical Editor

**JOHN R. RIGGS**  
Managing Editor

**IVAN BERGER**  
Senior Editor

**ALEXANDER W. BURAWA**  
Features Editor

**EDWARD I. BUXBAUM**  
Art Director

**JOHN McVEIGH**  
Associate Editor

**ANDRE DUZANT**  
Technical Illustrator

**PATRICIA GIRRIER-BROWN**  
Production Editor

**DORIS A. MATTHEWS**  
Editorial Assistant

Contributing Editors  
**Hal Chamberlin, Lou Garner, Glenn Hauser**  
**Julian Hirsch, Ralph Hodges, Forrest Mims**  
**Ray Newhall, Wilfred Scherer**

**JOSEPH E. HALLORAN**  
Advertising Director

**JOHN J. CORTON**  
Advertising Sales

**LINDA BLUM**  
Advertising Service Manager

**PEGI McENEANEY**  
Executive Assistant

**EDGAR W. HOPPER**  
Publishing Director

ZIFF-DAVIS PUBLISHING COMPANY  
Popular Electronics  
Editorial and Executive Offices  
One Park Avenue New York, New York 10016  
212-725-3500

Hershel B. Sarbin, President  
Furman Hebb, Executive Vice President  
John R. Emery, Sr. Vice President, Finance and Treasurer  
Phillip T. Heffernan, Sr. Vice President  
Edward D. Muhlfeld, Sr. Vice President, Sports Division  
Philip Sine, Sr. Vice President  
Frank Pomerantz, Vice President, Creative Services  
Arthur W. Butzow, Vice President, Production  
Lawrence Sporn, Vice President, Circulation  
George Morrissey, Vice President  
Sydney H. Rogers, Vice President  
Sidney Holtz, Vice President  
Albert S. Traina, Vice President  
Philip Korsant, Vice President  
Paul H. Chook, Vice President  
Edgar W. Hopper, Vice President  
Charles B. Seton, Secretary  
William Ziff, Chairman  
W. Bradford Briggs, Vice Chairman

Midwestern Office  
The Pattis Group, 4761 West Touhy Ave.,  
Lincolnwood, Illinois 60646, 312 679-1100  
Thomas Hockney, Michael Neri, Gerald E. Wolfe  
Western Office  
9025 Wilshire Boulevard, Beverly Hills, CA 90211  
213-273-8050; BRadshaw 2-1161  
Western Advertising Manager: Bud Dean  
Japan: James Yagi  
Oji Palace Aoyama: 6-25, Minami Aoyama  
6 Chome, Minato-Ku, Tokyo 407-1930/6821,  
582-2851



The publisher has no knowledge of any proprietary rights which will be violated by the making or using of any items disclosed in this issue.



## Editorial

### ELITISM FINELY DRAWN

The results of the mythical quiz on electronics sent to our 400,000 or so primary readers as a prelude to accepting their subscriptions have finally been tallied (by computer, of course).

The first part of the test was simple enough. It concerned dc theory;  $I=E/R$  and all that. Only 5% failed, leaving us with 380,000 potential readers. The second test covered ac theory, which included vector algebra and some trigonometric functions. (We graciously supplied formulas.) An impressive-enough number handled polar coordinates, the  $j$  factor and the Pythagorean theorem to earn our respect. We only lost 15% of the remaining subscribers on this one, leaving us 323,000 electronics buffs.

In the third section, circuit analysis techniques, we decided to forgive those who missed solving multiple-source networks with the superposition theorem. After all, this could be picked up quite easily. Employing this tactic, 258,400 determined people were left. (Females did better on this one, though they account for only 0.1% of the testees.)

I must be candid and say that I did not fully agree with the questions posed in the fourth part. They covered too much ground, I believe, ranging from transistor theory to operational amplifier operation with feedback, inverting, etc., as well as radio and TV circuits. After all, how many of us can draw a synchroguide circuit from memory? So we marked everyone right on this one problem. Nevertheless, a hefty 30% dropped by the wayside, with 180,880 left.

The fifth part really separated the men from the boys. It concerned digital electronics. Most did rather well on gates and such, but when it came to Karnaugh-Veitch maps. . . . Would you believe only about 18,000 made it? It was the  $n$  variables that did it!

The final test was composed of a *potpourri* of special interests, designed to check the broad base of electronics knowledge that our potential readers had. It included an analysis of SQ and QS matrix systems, designing a proportional control system for radio-control purposes, interpreting a host of logic timing scope traces, Brillouin scattering (everyone should know something about quantum electronics, right?), and an essay on how the Intel 8080 MPU works, among others.

To our surprise, only one person came through with flying colors—Marcia Swampfelder. This single subscription was processed.

After publishing our next issue for one subscriber, we instituted a PE reader attitude study (to keep a finger on the pulse, so to speak). The only subscriber left responded: "I'm too qualified to fully enjoy it."

The moral of this parable is clear. Elitism can be carried too far. That's why POPULAR ELECTRONICS touches all bases in electronics—high level and lower level, from audio to microcomputers, from news to new-development details, tutorials and construction projects. Through PE, there's always the joy and stimulation of being exposed to some facet of electronics that is new to a reader. The excitement is in unfamiliarity, whether it's a PE "breakthrough" project, a refreshingly different description of a device to give one new insight, or an explanation of how a particular circuit works. Happily, too, age is not a disqualifier, as attested by two sixth-grade girls who recently won the Crest Hill Science Fair in Wyoming with a Kirlian photography project. They said, "What we learned came mostly from POPULAR ELECTRONICS magazine."

*Art Salsberg*



# EVERY PROJECT IN THIS BOOK IS ANOTHER REASON TO OWN CSC'S QT SOCKETS AND BUS STRIPS.

With QT solderless bread-boarding sockets and bus strips, you can build twice the projects in half the time. Because making connections or circuit changes is as fast as pushing in—or pulling out—component leads. No special clips or jumpers required, either.

When you're building circuits just for the fun of it, you can take them apart in minutes—not hours. So you save money by re-using parts, while eliminating heat damage to expensive components. Interlocking QT Sockets and Bus Strips are infinitely expandable, too: start small and "grow" breadboards as large as you wish.

For as little as \$3.00, you can get a lot more out of your time in electronics—so why not treat yourself to a QT Socket today?

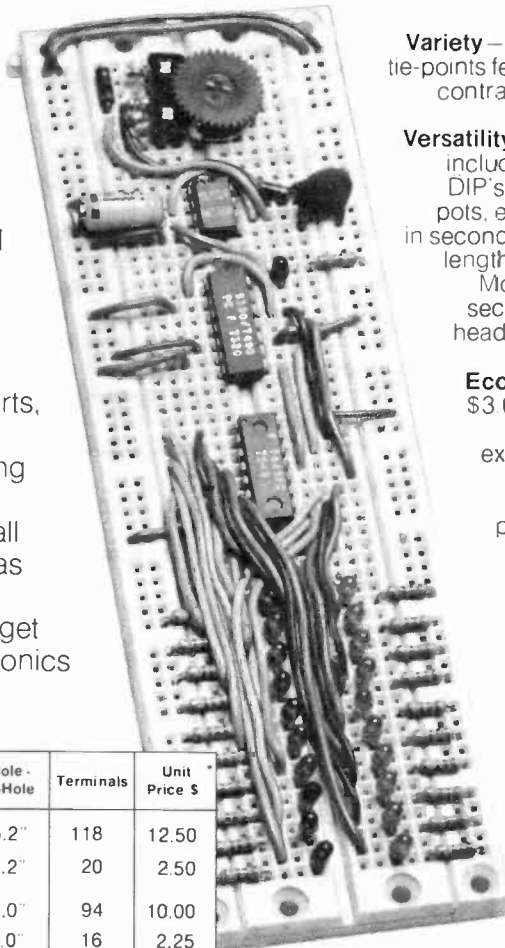

**Variety**—10 models from 70 to 590 solderless tie-points feature snap/lock design to expand or contract your breadboard to fit every circuit and budget requirement.

**Versatility**—Use with virtually all types of parts, including resistors, capacitors, transistors, DIP's, TO-5's, LED's, transformers, relays, pots, etc. Most plug-in directly and instantly, in seconds. No special jumpers required—just lengths of #22-30 AWG solid hookup wire.

Molded-in holes let you mount QT units securely on any flat surface with 4-40 flat head screws, or 6-32 self-tapping screws, from behind panel.

**Economy**—Sockets are priced as low as \$3.00\*. Save more money by eliminating heat and mechanical damage to expensive parts, re-using components.

**Speed**—For fast circuit layouts, QT Sockets have 5 interconnecting tie-points per terminal; Bus Strips feature 2 separate rows of interconnecting terminals. Both connect and disconnect easily, without damage to socket or parts.

**Visibility**—All parts are instantly and easily visible and accessible, for quick signal tracing, circuit analysis and diagramming.

**Durability**—Higher-temperature sockets with abrasion-resistant, glass-filled plastic, rated better than 100°C. Screw-down-and-interlocked design provides high mechanical strength.

**Reliability**—Ruggedly designed to professional engineering standards, for heavy day-in, day-out use. Non-corrosive prestressed nickel-silver contacts insure more secure mechanical and electrical connections. Vinyl backing prevents shorting when mounted on conductive surfaces.

Length Hole-to-Hole		Length	Hole-to-Hole	Terminals	Unit Price \$
	QT-59S	6.5"	6.2"	118	12.50
	QT-59B	6.5"	6.2"	20	2.50
	QT-47S	5.3"	5.0"	94	10.00
	QT-47B	5.3"	5.0"	16	2.25
	QT-35S	4.1"	3.8"	70	8.50
	QT-35B	4.1"	3.8"	12	2.00
	QT-18S	2.4"	2.1"	36	4.75
	QT-12S	1.8"	1.5"	24	3.75
	QT-8S	1.4"	1.1"	16	3.25
	QT-7S	1.3"	1.0"	14	3.00

All QT units are .33" thick.

See your CSC dealer or call  
203-624-3103 (East Coast) or 415-421-8872 (West Coast)  
major credit cards accepted.

\*Manufacturer's suggested list • Prices and specifications subject to change without notice  
© 1976, Continental Specialties Corporation

CONTINENTAL SPECIALTIES CORPORATION

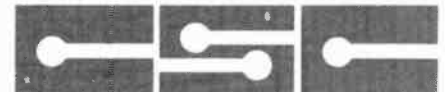

44 Kendall Street, Box 1942, New Haven, CT 06509  
203-624-3103 TWX 710-465-1227  
West Coast: 351 California St., San Francisco, CA 94104  
415-421-8872 TWX 910-372-7992  
MEXICO: ELPRO, S.A. Mexico City 5-23-30-04  
CANADA: Len Finkler Ltd., Ontario



## Empire's Blueprint For Better Listening

No matter what system you own, a new Empire phono cartridge is certain to improve its performance.

The advantages of Empire are threefold.

One, your records will last longer. Unlike other magnetic cartridges, Empire's moving iron design allows our diamond stylus to float free of its magnets and coils. This imposes much less weight on the record surface and insures longer record life.

Two, you get better separation. The small, hollow iron armature we use allows for a tighter fit in its positioning among the poles. So, even the most minute movement is accurately reproduced to give you the space and depth of the original recording.

Three, Empire uses 4 poles, 4 coils, and 3 magnets (more than any other cartridge) for better balance and hum rejection.

The end result is great listening. Audition one for yourself or write for our free brochure, "How To Get The Most Out Of Your Records." After you compare our performance specifications we think you'll agree that, for the money, you can't do better than Empire.



# EMPIRE

Already your system sounds better.

Empire Scientific Corp.  
Garden City, New York 11530

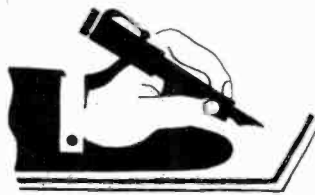

## Letters

### A BIT OF NOSTALGIA

"The Morse-A-Letter" in the January 1977 issue was particularly interesting to me because it brought to mind the tinkering I did in the late 1930's and early 1940's. At that time, I put together a "siphon" telegraph recorder that recorded code as a wiggly line on "ticker" tape at speeds up to 100 wpm. This copy could then be decoded by eye at speeds faster than I could copy by ear.

One of the peculiarities I found was that manual keying was much more difficult to read by eye than by ear due to the great variation in keying characteristics among the operators. I wonder if your digital system might have a similar problem. —George L. Rogers, WB9LVI, Waynesboro, VA.

*In on-the-air tests, we found very few instances where the Morse-A-Letter could not decipher code. In those rare cases where the converter "went wild," the operator of the received transmission had a very sloppy "fist."*

### UPPING THE COUNT RANGE

The "Photoelectric Sensor's" (January 1977) maximum count can be increased from 9 to 15 simply by replacing the 74192 (IC4) with a 74193 IC. Since these two IC's have exactly the same pinout, no other change in the basic circuit is needed. If a second 74193 is connected as shown in Fig. 2 of the article, the maximum count would be 255. —Charlie D. Hefley, Pasadena, TX.

### VIDEO GAMES AND PIX TUBE ETCHING

I note that POPULAR ELECTRONICS has recently presented a number of construction articles for inexpensive video games. While it is true that such games do provide many hours of entertainment, nowhere in any of the articles is it mentioned that court boundaries, paddles, etc., displayed on-screen can etch the expensive receiver picture tube. Believe me, this is a very real problem. I should know because I work for a vending service. —B.M. Michaud, Lake Placid, NY

*Though it is true that some commercial "arcade" types of video games have exhibited this "etching" process, there does not appear to be a similar problem in a home-entertainment system. Commercial vending games (and retail video game demonstrators) are generally operated 12 or more hours every day, which, over a long period of time can affect the CRT's phosphor. A video game used in a home, is not likely to be operated over prolonged periods of time.*

### GETTING PIN NUMBERS STRAIGHT

I was unable to obtain the recommended Hewlett-Packard 5082-7340 hex displays for my "COSMAC Elf" microcomputer (August 1976). So, I had to substitute Texas Instruments TIL311 displays. Unfortunately, the pinout table supplied with the TI displays contained several errors that other POPULAR ELECTRONICS readers might want to know about. The TI displays will work fine if the following pin substitutions are made:

H-P DISPLAY PIN NO.	TI DISPLAY PIN NO.
1	2
2	13
3	12
4	8
5	5
6	7
7	1,14
8	3

Do not connect pins 4, 6, 9, 10, and 11 of the TI displays. —Clayton Hallmark, Shelby, OH

### TESTING SEQUENTIAL IC'S

The "Digital IC Tester" (June 1977) may operate satisfactorily when combinational logic such as AND gates and BCD-to-decimal devices are tested, but it will not do a good job when testing sequential circuits like latches and counters. As an example, the 7490 decade counter shown in the article is made up of three JK flip-flops and one SR flip-flop. The set input of the last flip-flop will never be tested. Because the reset to zero and gate are conditioned before every fourth clock pulse at pin 1, inputs S1 and S2 will never both be high when the clock is applied to the toggle inputs of the SR flip-flop. Since the set input is never tested, it may be defective, but the IC would still pass the test. —Richard Bipes, Rochester, MN

*Your statements would be basically correct—if the 7490 were connected only as shown in the example in the article. However, the jumpers on the setup matrix can be arranged to test of any part of a digital IC.*

### MAKING IT WORK

When I built the "Digital Electronic Westminster Clock" (November 1976), I had problems getting it to operate properly. I found that pin 23 of IC19 must be connected to V<sub>DD</sub> when fluorescent displays are used. Also, H at the junction of C3 and R9 should be connected to pin 13 of IC19 for a one-hour pulse. Now my Westminster clock operates fine. —Larry Baxter, New Rochelle, NY

### FILTERING OUT THE NOISE

I am very happy with the performance of my "Digital Bicycle Speedometer" (March 1977). However, I would like to pass on to other readers a slight addition I had to make to the circuit to obtain proper operation. The 556 IC I used for IC3 was so noisy that the power supply had to be filtered. I solved this problem by installing a 2000- $\mu$ F electrolytic capacitor between pin 4 of IC3 and the ground, or common, bus. —Rob Breffeilh, Shreveport, LA

# LCD Watch Breakthrough...

# MICRO-ALARM



a 6-digit 6 function LCD Alarm Watch for only \$69.95!

At last, a constant readout (no buttons to push) precision quartz electronic watch with a built-in 24 hour alarm system.

A quiet revolution has been taking place in the electronic watch industry during the last few years. Push-button LED's are being replaced with continuous-display LCD watches; 4-digit displays are being replaced by 6-digit readouts. This year there will be many such LCD watches available.

However, Winthrop-Rogers prides itself on offering not only the most technologically-perfect products available, but also on introducing the most technologically-advanced products on the electronic market before they are readily available. Therefore, we are pleased to announce the most remarkable achievement in electronic watch technology to-date.

By combining the quartz-accuracy precision of the LCD watch with miniaturized alarm technology, we proudly introduce the first CONTINUOUS DISPLAY ALARM WATCH. A watch that may not be available from other sources for years can now be yours at a price hundreds of dollars less than you would imagine.

And now consider the incredible convenience of a portable alarm clock handsomely adorning your wrist at all times !!!

12:34 AND 56  
SECONDS

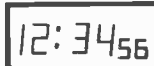

#### 6-DIGIT LCD DISPLAY

The MICRO-ALARM has a 6-digit readout showing hours, minutes and seconds at a glance. Since the readout is by Liquid Crystal Display (LCD) and not by Light Emitting Diode (LED), no button has to be pushed; the time is continuously displayed! A built in night-light functions at the push of a button for reading in darkness.

AUGUST 15th  
FRIDAY

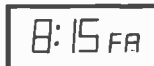

#### CALENDAR DISPLAY

Just one push of the control button converts the display into a 3-function calendar; displaying the month, date of the month, and day of the week. The remarkable memory built into the module knows each month and the number of days in that month and resets automatically on the first day of the new month.

#### QUARTZ ACCURACY

The MICRO-ALARM is extraordinarily accurate. Its module is manufactured by Hughes Aircraft Company, one of the world's foremost manufacturers of micro-electronics, and is guaranteed accurate to within 3 minutes a year (averaging less than 15 seconds per month). You can depend on the accuracy year after year. There are no moving parts, so there is nothing to wear out or even require servicing. The result of this accuracy is that you can set your watch to the second.

#### THINK ABOUT IT!

Even if you have no consistent need for a watch with a built-in electronic alarm, the MICRO-ALARM is a valuable investment for its watch features alone:

1. It is the most up-to-date fully-functioning electronic watch available today.
2. It is accurate to +/- 15 seconds per month, and never has to be wound — put it on, and the time and date are correct even if it has been in a drawer for a month!
3. Its elegant styling will compliment any attire — and elicit compliments from your associates and friends.
4. At this price you can not find a better buy.
5. One day you will have a critical need to be reminded of a vital appointment — and then, having used the alarm function once, you will never again return to any other reminder system.
6. Why buy an ordinary watch when you can own a MICRO-ALARM?

#### ELEGANT MESH BRACELET

Each MICRO-ALARM comes with a 1 year limited warranty. You may order in your choice of gold-tone or silvertone case. Each for only \$69.95 plus \$1.99 for shipping and handling. Each MICRO-ALARM comes with a matching, elegant, thin mesh bracelet, more handsome and much more practical than those "pull over-snap" type bracelets. This band adjusts comfortably and easily, eliminating cumbersome link adjustments.

#### 15 DAY TRIAL

Wear the MICRO-ALARM for 15 days to assure yourself that this is no ordinary watch. If at the end of that time you are dissatisfied for any reason you may return it for a prompt refund, no questions asked.

To order by credit card please phone our 24-hour toll-free number:

**800-325-6400 ask for Oper. 36**

In Missouri: 800-342-6600 ask for Operator 36

or mail the attached coupon with your payment and the MICRO-ALARM will be on its way to you.

Allow 3-4 Weeks For Delivery

Winthrop-Rogers Ltd. V5408

Box A69, 1135 Greenridge Rd., Buffalo Grove, IL 60090

Please send \_\_\_ MICRO-ALARMS @ \$69.95 each plus \$1.99 for shipping and handling.

\_\_\_ Silvertone MICRO-ALARM  
\_\_\_ Goldtone MICRO-ALARM

If I am not completely satisfied I may return it for a full refund. Total amount enclosed \$\_\_\_\_, check or money order. (Illinois residents please add 5% sales tax.) No C.O.D.s please.

Charge:  Amer. Exp.  Bank Amer./Visa  
 Master Charge MCBK # \_\_\_\_\_

Card # \_\_\_\_\_ Exp. \_\_\_\_\_

Signature \_\_\_\_\_

Name \_\_\_\_\_

Address \_\_\_\_\_ Apt. \_\_\_\_\_

City \_\_\_\_\_ State \_\_\_\_\_ Zip \_\_\_\_\_

To expediate shipping by UPS, please provide street address rather than P.O. Box number.

- Never again missing an appointment because you lost track of time.
- Never again missing a plane or a train because you didn't realize how late it had become.
- Never again forgetting to make that all-important phone call.
- Never having to worry about forgetting to take important medication on time.
- Never worrying about waking up from that catnap, or at a hotel if your wake-up call isn't on time.
- Always being aware of when you should be coming or going or doing all that your hectic schedule demands — without devoting your valuable time to trying to remember it all.



SET TO RING  
AT 7:55 A.M.

#### THE ALARM

The MICRO-ALARM has a 24 hour Alarm System, allowing you to set your watch to signal at any minute of the day or night (1,440 settings per day are possible). Once set, you need not be concerned about your next appointment or train, plane or phone call. The MICRO-ALARM will remember for you and remind you when you need to be reminded.

#### SNOOZE/REMINDE CONTROL

For your convenience the MICRO-ALARM will give one short beep prior to its full alarm cycle, allowing you to turn it off without disturbing others. If not deactivated after the first short beep, the alarm will then beep for 15 continuous seconds. Push the deactivate button twice and the alarm is off. However, should you want a further reminder, then push the deactivate button only once and the alarm will go through its cycle again in exactly 5 minutes, allowing you to continue your current activity whether it be a snooze or phone call without fear of forgetting your next commitment.



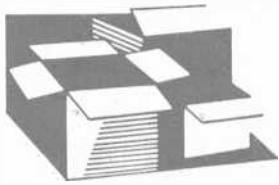

# New Products

*Additional information on new products covered in this section is available from the manufacturers. Either circle the item's code number on the Reader Service Card inside the back cover or write to the manufacturer at the address given.*

## TRIPLETT HAND-SIZED VOM

The new Model 100-T from Triplett is a hand-sized VOM featuring temperature ranges from -50 to +300 degrees F. A handy leather carrying case includes temperature probes, VOM leads, clamp-on ac ammeter,

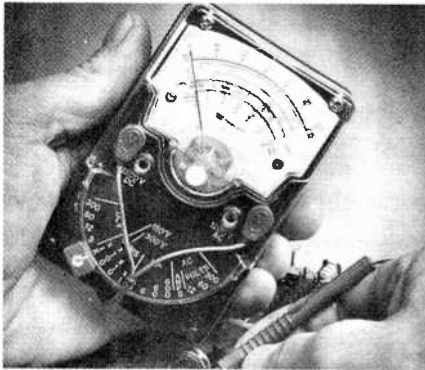

plus a plug-in line separator for current readings on standard line cords. The 100-T consists of the company's basic Model 390 "shirt pocket" VOM with five ac/dc voltage ranges (0-1200 volts), four dc milliamp ranges (0.6-600 mA), and four ohm ranges (10 k to 10 M). Dc sensitivity is 20 kilohms/volt; ac is 5 kilohms/volt. \$120.

CIRCLE NO. 88 ON FREE INFORMATION CARD

## AUTOMATIC RADIO STEREO POWER BOOSTER

Featuring dual amplifiers in a compact case for underdash mounting, the Automatic Radio PWR-2125 stereo power booster attaches to the output of any stereo radio or tape player. It boosts the power up to four times, to a total of 30 watts rms. A pushbutton allows switching from normal- to boost-power mode. \$34.95.

CIRCLE NO. 89 ON FREE INFORMATION CARD

## NEOSONIC CB SPEAKER

A CB speaker with a hinge that permits mounting virtually anywhere in cars, trucks, recreation vehicles, vans, tractors, base stations and boats, the Neosonic FS-10 measures 3 3/4" in diameter and 4" deep. It is said to provide high-quality sound over the 300- to 4000-Hz voice range because of a built-in

sharp cutoff LC filter, with a response curve tailored for maximum intelligibility of CB signals. The FS-10 has an 8-ohm impedance and weighs just over 5 ounces. \$14.95.

CIRCLE NO. 91 ON FREE INFORMATION CARD

## ONKYO "QUARTZ-LOCKED" FM TUNER

Onkyo's Model T-9 AM/Stereo FM "quartz-locked" tuner uses a front-end dual-gate MOSFET. Mono FM sensitivity is rated at 3  $\mu$ V (16.1 dBf) at 50 dB quieting; image rejection, 83 dB; and stereo S/N ratio, 73-dB. PLL

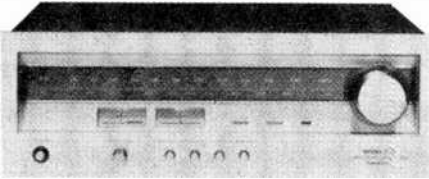

multiplex circuitry provides 40-dB stereo separation at 1000 Hz. A touch-sensitive FM tuning knob unlocks the frequency comparator and automatically activates a muting circuit when tuning in a station. Also featured are separate signal and center-channel tuning meters. Front-panel pushbutton switches are provided for POWER on/off, injecting a 400-Hz recording signal for tape recording, MUTE/LOCKED function, stereo noise filter, and AM/FM selection.

CIRCLE NO. 92 ON FREE INFORMATION CARD

## TARBELL MICROPROCESSOR PROTOTYPING

The Model 1010 prototyping board from Tarbell Electronics can be used with the 8080-microprocessor based microcomputers made by MITS and IMSAI. The board accepts up to 33 14-pin IC's or a mixture of 40-, 24-, 18-, 16-, and 14-pin DIP IC's. Mainly oriented toward point-to-point soldering, the board can also be used for Wire Wrap. There are three rows for IC's. The IC's or their sockets are inserted from the top of the board and then wires are soldered to the adjacent tabs. Even with 40-pin IC's, there are two holes left over on each pin for hooking up wires. A place for a 5-volt regulator is provided on the board, and edge-connector pads are gold plated. \$28.00.

CIRCLE NO. 93 ON FREE INFORMATION CARD

## ELECTRA PROGRAMMABLE SCANNER

The Bearcat 210 scanning monitor receiver gives the user pushbutton access to more than 6000 public-service frequencies. The five-band crystalless receiver employs completely synthesized circuitry. Any 10 frequen-



cies can be programmed into the receiver in a matter of seconds. The scanning rate is 20 channels/second. A large digital numeric display allows the operator to see the frequencies he has selected as well as those being received. Bearcat's exclusive rolling zeroes indicate when the scanning function is active. A 2-second scan delay allows the listener to hear both parts of a two-way broadcast. A pushbutton lock-out feature permits selective skipping of those channels the user does not wish to monitor. The receiver can be operated on either ac or battery power.

CIRCLE NO. 94 ON FREE INFORMATION CARD

## TEAC CASSETTE DECK

Model A-103 front-loading, all black design cassette deck from Teac features Dolby noise reduction, two-step bias and equalization switches, Permaflux heads for record/playback and erase, separate left and right level controls, and a mic or line input switch. Wow and flutter is rated at 0.10%; frequency



response 30-14,000 Hz with chromium dioxide tape; signal-to-noise ratio 50 dB, improved to 10 dB at 5000 Hz with Dolby. Dimensions: 17 5/16" x 9 5/8" x 7 11/16" (40 x 24 x 20 cm). \$180.

CIRCLE NO. 95 ON FREE INFORMATION CARD

## VECTOR WIRE-WRAPPING TOOL

Vector's P160-9 is a double-ended tool with a wrapping bit on one end and an unwrapping bit on the other. Designed for use either with Vector's battery-powered P160-4R power



POPULAR ELECTRONICS

# Revolutionary breakthrough in CB antenna design



PATENT PENDING

Photo courtesy of Edmund Scientific Co.

## AVANTI Invents the Saturn™ Base

The reason the "Saturn" is so revolutionary is that it is absolutely the only **combination vertical and horizontal omni-directional antenna**. That's right, it needs no rotor! You can pick up mobiles (which are vertical) or horizontal and vertical beams.

The "Saturn", invented after years of research by Avanti engineers, is the latest development using AVANTI's unique CO-INDUCTIVE principle to give you the performance of two antennas combined into one.

The "Saturn" not only works on both polarities, but pounds out signals like an air hammer and picks them up like a magnet. Both polarities offer high gain figures.

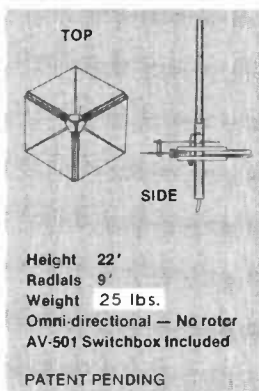

Those of you who are worried about sun spots and "skip" can relax too. This antenna really helps. When the sun spots cause a signal shift, you can often change polarity (just like our P.D.L. or Moonraker) and still pick up the desired channel with no loss of transmission.

The P.D.L. and Moonraker made dual polarity famous as the only antennas to have during the last sun spot cycle, and this time around any serious C.B.'er will want to have the "Saturn."

In fact, having a "Saturn" and a "P.D.L." or "Moonraker" will put you in the elite group of C.B.'ers who "always seem to get out better."

Avanti makes a complete line of high performance base and mobile CB antennas from \$11.95 to \$404.00. Write for free Avanti catalog.

# avanti

AVANTI RESEARCH AND DEVELOPMENT, INC.,  
340 Stewart Avenue, Addison, IL 60101

© Copyright 1977, All rights reserved

Creators of the famous

# MOONRAKER®

CIRCLE NO. 7 ON FREE INFORMATION CARD

AmericanRadioHistory.Com



# The "Click and Pop" machine

only by  
**SAE**

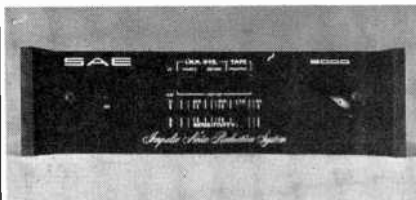

Ever since the invention of the recorded disc annoying "clicks" and "pops" caused by scratches, static and imperfections have consistently disturbed the listening pleasure of music lovers.

Now, SAE introduces the unique model 5000, an Impulse Noise Reduction System which eliminates those unwanted sounds with no adverse effect on the quality of the recorded material.

This breakthrough in electronic circuitry is so demonstrably effective that the SAE 5000 is destined to become an essential part of any sound system.

The SAE 5000 is compact and sleek, built to SAE's exacting standards, and ready to enhance the performance of any system, from the standard receiver/turntable combination, to the most sophisticated audiophile components.

SAE is proud to add the 5000 to their broad line of *Components for the Connoisseur*.

## SAE

Scientific Audio Electronics, Inc.  
P.O. Box 60271, Terminal Annex  
Los Angeles, Cal. 90060

Please send more information on the 5000.

Name \_\_\_\_\_

Address \_\_\_\_\_

City \_\_\_\_\_

State \_\_\_\_\_ Zip \_\_\_\_\_

PE-877

CIRCLE NO. 49 ON FREE INFORMATION CARD

tool, or for manual wrapping, the tool makes gas-tight terminations on 0.025-inch square posts, using 26 to 30 AWG wire. The wrapping bit's 0.07-inch radius allows terminations on posts on 0.1-inch centers. A bit depth of 0.56 inch permits three wrap levels. The P160-9 Wrap-N-Unwrap tool is \$18.40, and the P160-4R power tool is \$45.68.

CIRCLE NO. 96 ON FREE INFORMATION CARD

### HUNT IGNITION NOISE SUPPRESSOR

"Phantom Damper" is what Hunt CB Accessories is calling its noise filter which, it claims, eliminates from 75% to 100% of all vehicle engine noise from CB radios. Housed in a small black box, approximately 1½ inches square, the unit is installed in the vehicle between the alternator and CB unit. Equipped with self-adhesive backing, installation is said to take only 15 minutes. It may be attached directly to the CB unit or any convenient location within 12 inches of the set. A power cable runs from the Damper through the vehicle's firewall to the battery and shielded coax runs from the Damper to the CB unit. A red LED lamp, located on the Damper, glows when all connections are tight and unit is correctly grounded. \$39.95. Address: Hunt CB Accessories, Box 489, Eaglepoint, OR 97524.

### JOHNSON CB RADIO WITH FLASHING METER

E.F. Johnson's new 40-channel, mobile CB AM transceiver, the Messenger 4145, is equipped with a "Power Bar" LED meter which indicates received signal strength and relative power output with red LED segments.



It can also function as an attention-getting "silent alert" light when operating the radio with the volume control off. Other features are a PA function, built-in electronic speech compression, a tapered switchable automatic noise limiter, PLL circuitry on a single IC chip, a dimmer switch, and positive/negative ground power capability. Accessories available include an external speaker and ac power supply for base operations. \$179.95.

CIRCLE NO. 97 ON FREE INFORMATION CARD

### B&K-PRECISION INSTRUMENT PROBE

A new deluxe wideband instrument probe, designated the Model PR-37, has been announced by B&K-Precision. It is designed to be used with frequency counters and oscilloscopes at frequencies up to 100 MHz. The

lightweight, slim-bodied probe has a three position switch that allows selection of 10:1 or direct modes or a reference position that grounds the tip through a 9-megohm resistor. A complete set of accessories is supplied with the probe, including a spring-loaded retractable tip cover, insulating tip, BNC tip adapter, IC tip, and an insulated compensation capacitor adjustment tool. The insulating tip is designed for probing dense solid-state circuitry with no danger of shorting to nearby components. The BNC adapter converts the probe tip into a push-on BNC connector. The IC tip guides the probe contact onto any pin of a DIP, making it almost impossible to short two pins of an IC. \$40.00.

CIRCLE NO. 98 ON FREE INFORMATION CARD

### HITACHI STEREO RECEIVER

Hitachi has expanded its Series "E" line of audio components with the Model SR-2004 AM/stereo FM receiver, rated at 200 watts/channel, 0.8% THD (20 Hz to 20 kHz at 8 ohms). It incorporates the company's Class "G" amplifier circuit design and is said to be capable of delivering up to 400 watts/channel of transient music power within rated distortion. Features include dual power-output meters, separate signal and tuning meters, mi-

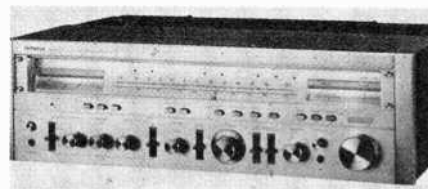

crophone mixing, turnover tone controls, audio mute lever switch, FM muting/auto-lock switch, MPX noise-filter, i-f wide/narrow switch, three front-panel speaker system selector switches, and tape copy and monitor switches. In addition, performance specifications include 1.5 µV FM sensitivity, 85 dB selectivity and 50 dB stereo separation. \$1000.

CIRCLE NO. 99 ON FREE INFORMATION CARD

### MITS AUDIO CASSETTE INTERFACE

The MITS Model 680b-KCACR is designed to interface the Altair 680b microcomputer's bus with an audio cassette recorder/player to provide a mass data storage/retrieval medium. The circuitry is based on the Kansas City Standard. Other design features include a digital demodulator, CMOS logic for low power consumption, a motor control circuit for starting and stopping tape motion, and test points at key locations in the circuit. All IC's are socketed. A complete set of documentation containing diagnostic software, test-point waveforms, theory of operation, and a detailed operator's section is provided. Altair 680b BASIC, Version 1.2, has been developed for use with the system and includes the standard functions and operations of 680b BASIC as well as the capability to store and load software through the interface system.

CIRCLE NO. 100 ON FREE INFORMATION CARD

POPULAR ELECTRONICS

# ok<sup>®</sup> wire wrapping center ok<sup>®</sup>

ANOTHER UNIQUE PRODUCT  
**DESIGNED, MANUFACTURED  
AND MARKETED WORLDWIDE**  
BY  
OK MACHINE & TOOL CORPORATION

1

BATTERY WIRE-WRAPPING TOOL MODEL BW-630



**\$34.95\***

STRIP / WRAP / UNWRAP TOOL MODEL WSU-30

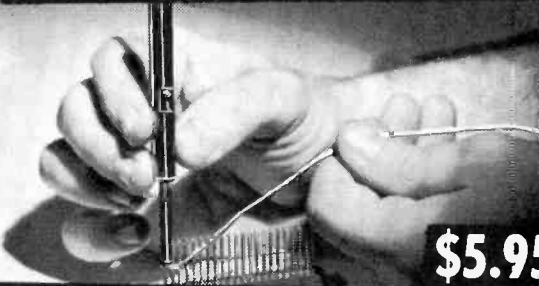

2

**\$5.95\***

ANOTHER UNIQUE PRODUCT  
**DESIGNED, MANUFACTURED  
AND MARKETED WORLDWIDE**  
BY  
OK MACHINE & TOOL CORPORATION

ANOTHER UNIQUE PRODUCT  
**DESIGNED, MANUFACTURED  
AND MARKETED WORLDWIDE**  
BY  
OK MACHINE & TOOL CORPORATION

3

WIRE DISPENSER MODEL  
WD-30-B

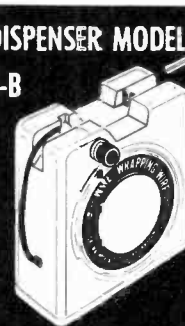

THE DISPENSER WHICH  
CUTS AND STRIPS  
THE WIRE

**\$3.45\***

DIP IC INSERTION TOOL WITH PIN STRAIGHTENER  
MODEL INS-1416

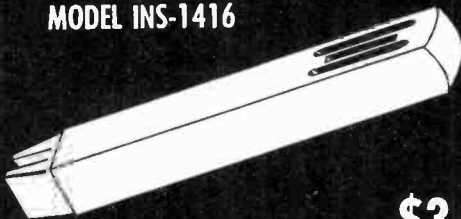

4

**\$3.49\***

ANOTHER UNIQUE PRODUCT  
**DESIGNED, MANUFACTURED  
AND MARKETED WORLDWIDE**  
BY  
OK MACHINE & TOOL CORPORATION

ANOTHER UNIQUE PRODUCT  
**DESIGNED, MANUFACTURED  
AND MARKETED WORLDWIDE**  
BY  
OK MACHINE & TOOL CORPORATION

5

**WHAT'S ? NEXT**

\* MINIMUM ORDER \$25.00, SHIPPING CHARGE \$1.00, N.Y. CITY AND STATE RESIDENTS ADD TAX

**OK MACHINE & TOOL CORPORATION**

3455 Conner St., Bronx, N.Y. 10475 ■ (212) 994-6600 ■ Telex 125091



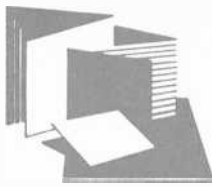

# New Literature

## HUSTLER CB ANTENNA CATALOG

The Hustler 1977 revised 26-page CB and Monitor antenna catalog is offered by New-

Tronics. Mobile and base station antennas are illustrated with special designs including the "Homing Pigeon," the "Hustloff" and "Super Hustler." A selection of 40-channel antennas and hardware is also described plus a new series for recreational vehicles. Address: New-Tronics Corp., 15800 Commerce Park Dr., Brookpark, OH 44142.

## LOUDSPEAKER CATALOG

"Quam '77, The Sound Decision" is the title of the new, 12-page catalog from Quam-Nichols. Listed are 127 models, including mobile 2-way radio replacement speakers and updated listings of general-purpose, automo-

tive, high-fidelity, music-instrument and sound-system loudspeakers and matching line transformers. Specifications for each speaker provide information on dimensions, frequency response, power handling capability, voice coil impedance and diameter, and magnet material and weight. Line drawings illustrate configurations and mounting dimensions. Address: Quam-Nichols Co., 234 E. Marquette Rd., Chicago, IL 60637.

## MOTOROLA EXCLUSIVE-RADIO-CHANNEL GUIDE

"Introducing a New Dimension In Radio Communications" is a guide offered by Motorola for land mobile business radio operators interested in interference-free, FM 2-way radio communication. The booklet provides information on the FCC's decision to assign an exclusive channel to any user who can meet the 800-MHz loading requirements. Address: Motorola Communications Group, Literature Distribution Center, 1301 E. Algonquin Rd., Schaumburg, IL 60196.

## BREADBOARDING & TEST EQUIPMENT

The 24-page, Spring 1977 Breadboarding and Test Equipment Catalog is available from Continental Specialties. The company's line of solderless breadboards (including the Experimentor series which snap-together to suit circuit design) are described, along with protoboard kits; logic monitors; logic probes; and equipment for design troubleshooting and testing. A section describing components is also included. Address: Continental Specialties Corp., 44 Kendall St., Box 1942, New Haven, CT 06509.

## RCA BiMOS OP AMP BULLETIN

Data Bulletin, File No. 976, describing the CA3160 series of BiMOS operational amplifiers, is available from the RCA Solid State Division. The CA3160 series are frequency-compensated versions of the popular CA3130 COS/MOS operational amplifiers. Features include high input impedance and low input current, wide bandwidth (15 MHz), high slew rate, and strobing capability to reduce standby power consumption. Applications include voltage followers and regulators, and voltage-controlled oscillators. Address: RCA Solid State Div., Box 3200, Somerville, NJ 08876.

## VOR RECORD CLEANER BROCHURE

VOR Industries offers a 4-color brochure describing the benefits and operation of its Vac-O-Rec "dry" vacuum record cleaner. Address: Sales Dept., VOR Industries, 1440 S. State College Blvd., Unit 5H, Anaheim, CA 90806.

## STACO POWER SUPPLIES SPEC SHEET

A spec sheet from Staco, Inc. describes its line of regulated and filtered power supplies for "home base" operation of mobile CB radios, stereos, and tape decks. Technical data, features and application information are provided. Address: Staco, Inc., 2240 E. 3rd St., Dayton, OH 45403.

**NEW!**  
LIGHT YEARS  
AHEAD—

# Little Dipper™

**LOADS** from any surface or magazine

**ALIGNS** leads — adjustable.

**INSERTS** with no stress.

- **FASTEST** manual device available
- **Will not wear out**
- **Safe** — will not damage devices
- **Adjustable**
- **Easy to use**

**FREE CATALOG**

**TECHNI-TOOL INC.**

Apollo Road, Plymouth Mtg., Pa. 19462  
(215) 825-4990 Tlx 83-4763

Distributors Wanted

CIRCLE NO. 56 ON FREE INFORMATION CARD

—As featured in March 1976 Popular Electronics—

## The Incredible "Pennywhistle 103"

Think Of It As The Ultimate!



4' interconnect cable \$15.95

**\$129.95**

(plus \$3.50 for postage and handling). California residents add 6 1/2% sales tax. Allow approximately four weeks for delivery.

The Pennywhistle 103 Acoustic Coupler is the first professional quality modem available in kit form. The Pennywhistle may be used either as an acoustic coupler (with the telephone handset) or it may be wired directly into the telephone. In either case, The Pennywhistle will operate in both the half-duplex (unidirectional) or the full-duplex (bidirectional) modes. The Pennywhistle 103 is capable of recording data to and from audio tape without critical speed requirements for the recorder and it is able to communicate directly with another modem and terminal for telephone "hamming" and communications for the deaf. In addition, it is free of critical adjustments and is built with non-precision, readily available parts. The Pennywhistle is the only Acoustic Coupler Modem Kit in the world with these features. The Pennywhistle represents many things in terms of operation, construction and concept. It is, in effect, a new generation of Acoustic Coupler Modems.

### —SPECIFICATIONS—

Data Transmission Method	..... Frequency-Shift Keying, full-duplex (half-duplex selectable).
Maximum Data Rate	..... 300 Baud.
Data Format	..... Asynchronous Serial (return to mark level required between each character).
Receive Channel Frequencies	..... 2025 Hz for space; 2225 Hz for mark.
Transmit Channel Frequencies	..... Switch selectable: Low (normal) = 1070 space, 1270 mark; High = 2025 space, 2225 mark.
Receive Sensitivity	..... -46 dbm acoustically coupled.
Transmit Level	..... -15 dbm nominal. Adjustable from -6 dbm to -20 dbm.
Receive Frequency Tolerance	..... Frequency reference automatically adjusts to allow for operation between 1800 Hz and 2400 Hz.
Digital Data Interface	..... EIA RS-232C or 20 mA current loop (receiver is optoisolated and non-polar).
Indicators	..... Red LED indicates power without carrier. Amber LED lights and red LED goes out upon acquisition of carrier. Data received causes both LEDs to flicker.
Power Requirements	..... 120 VAC, single phase, 10 Watts.
Physical	..... All components mount on a single 5" by 9" printed circuit board. All components included.

Requires a VOM, Audio Oscillator, Frequency Counter and/or Oscilloscope to align.



**M&R ENTERPRISES**

P.O. Box 61011, Sunnyvale, California 94088

# SWTPC announces first dual minifloppy kit under \$1,000



Now SWTPC offers complete best-buy computer system with \$995 dual minifloppy, \$500 video terminal/monitor, \$395 4K computer.



### \$995 MF-68 Dual Minifloppy

You need dual drives to get full benefits from a minifloppy. So we waited to offer a floppy until we could give you a dependable dual system at the right price.

The MF-68 is a complete top-quality minifloppy for your SWTPC Computer. The kit has controller, chassis, cover, power supply, cables, assembly instructions, two highly reliable Shugart drives, and a diskette with the Floppy Disk Operating System (FDOS) and disk BASIC. (A floppy is no better than its operating system, and the MF-68 has one of the best available.) An optional \$850 MF-6X kit expands the system to four drives.



### \$500 Terminal/Monitor

The CT-64 terminal kit offers these premium features: 64-character lines, upper/lower case letters, switchable control character printing, word highlighting, full cursor control, 110-1200 Baud serial interface, and many others. Separately the CT-64 is \$325, the 12 MHz CT-VM monitor \$175.



### \$395 4K 6800 Computer

The SWTPC 6800 comes complete with 4K memory, serial interface, power supply, chassis, famous Motorola MIKBUG® mini-operating system in read-only memory (ROM), and the most complete documentation with any computer kit. Our growing software library includes 4K and 8K BASIC (cassettes \$4.95 and \$9.95; paper tape \$10.00 and \$20.00). Extra memory, \$100/4K or \$250/8K.

**Other SWTPC peripherals** include \$250 PR-40 Alphanumeric Line Printer (40 characters/line, 5 x 7 dot matrix, 75 line/minute speed, compatible with our 6800 computer and MITS/IMSAI); \$79.50 AC-30 Cassette Interface System (writes/reads Kansas City standard tapes, controls two recorders, usable with other computers); and other peripherals now and to come.

#### Enclosed is:

- \_\_\_\_\_ \$1,990 for the full system shown above (MF-68 Minifloppy, CT-64 Terminal with CT-VM Monitor).
- \_\_\_\_\_ \$995 for the Dual Minifloppy
- \_\_\_\_\_ \$325 for the CT-64 Terminal
- \_\_\_\_\_ \$175 for the CT-VM Monitor
- \_\_\_\_\_ \$395 for the 4K 6800 Computer

\$250 for the PR-40 Line Printer  
 \$79.50 for AC-30 Cassette Interface  
 Additional 4K memory boards at \$100  
 Additional 8K memory boards at \$250  
 Or BAC # \_\_\_\_\_ Exp. Date \_\_\_\_\_  
 Or MC # \_\_\_\_\_ Exp. Date \_\_\_\_\_  
 Name \_\_\_\_\_ Address \_\_\_\_\_  
 City \_\_\_\_\_ State \_\_\_\_\_ Zip \_\_\_\_\_

CIRCLE NO. 54 ON FREE INFORMATION CARD

AmericanRadioHistory.Com



**Southwest Technical Products Corp.**

219 W. Rhapsody, San Antonio, Texas 78216  
**London:** Southwest Technical Products Co., Ltd.  
**Tokyo:** Southwest Technical Products Corp./Japan



# Stereo Scene

By Ralph Hodges

## TAPE TOPICS

**C**ONSEQUENTIAL things are suddenly happening in the consumer tape industry. I don't mean to refer to the Elcaset and similar evolutionary developments. Rather, the overall potential of consumer tape recording in any format is on the brink of giant steps forward in at least three and possibly four areas of research. The first step is probably only months away. The second involves a technology that is virtually perfected, but poses compatibility problems with almost all existing tape machines. The third will insinuate itself subtly over a period of some years. And the fourth is a total departure from anything that has gone before.

Let's take them as they (probably) will occur.

**The Hall Head.** The Hall effect, named after its discoverer, was happened upon late in the nineteenth century. It involves the ability of a suitably biased piece of semiconductor material (metallic compounds of antimony, arsenic, and other exotic metals being among those favored) to develop an "output" voltage proportional to any magnetic flux impinging on it. This is precisely what we want from the playback head of a tape recorder. But there is an important distinction! A conventional coil-wound playback head can only

respond to the rate of *change* in magnetic flux (the crossings of magnetic lines of force), and hence it *cannot* respond to a tape that is not moving. A Hall device can, however (with a steady and triumphant dc output). This opens a delightful Pandora's Box of possibilities.

The possibilities are all based on the virtual elimination of playback equalization in tape machines. Conventional playback heads, being rate-of-change dependent, exhibit a rising output with rising frequency, and hence must be compensated by "lossy" equalization circuits to restore flat frequency response. Additional gain stages must then be used to repair the losses, and the noise contribution from the electronics becomes a significant problem.

A Hall-effect device could care less about rate of change. Instantaneous flux determines its output, which is therefore independent of frequency and essentially "flat" from any properly recorded tape. Of course, gap losses at high frequencies are still a factor (present Hall-effect heads use conventional head "yokes" of laminated iron with carefully defined gaps), but the amount of equalization necessary to compensate for them is comparatively (and audibly) trivial.

At a press conference in late April, Hitachi announced the intention of installing Hall-effect playback heads into

three-head cassette machines within the year. (At present no application for the Hall effect in record heads is foreseen, so any Hall tape recorders will necessarily have to be three-head devices.) The Hitachi people allowed that development, requiring an exceedingly thin slab of material, was frustratingly difficult. (A vapor-deposited film of indium antimonide on a ferrite substrate is used, amounting to a total thickness of about 1 micron.) The resulting playback head, lacking bulky coils, is quite compact, permitting it to nestle that much closer to the record head in a cassette deck. It thus further reduces the possibility of tape skew between record and play gaps.

Another benefit legitimately claimed for the Hall head is a drastic reduction in phase shift (academic when you consider that the record head has already introduced copious phase shift, but of interest all the same). The Hitachi spokesman, Dr. Miyazaki, also claimed that the Hall head developed by his company is intrinsically less noisy than a coil-wound playback head. If true, this (and all the rest of the benefits) should put a good ferric tape recorded without Dolby noise reduction (and played on a Hall-head machine) within easy reach of a chromium-dioxide tape recorded *with* noise reduction.

**Fe "Yes," Fe<sub>2</sub>O<sub>3</sub> "No!"** But who cares about ferric-oxide tape if a pure-iron tape can do much better? I first heard about tape coatings containing pure metal particles (not oxides) several years ago. At that time, Philips was talking about some remarkable results achieved with pure-iron tapes. The major fly in the ointment was that these tapes tended to corrode rapidly and even burst into flame spontaneously when used in an atmosphere containing oxygen. Now 3M, in a recent announcement, claims to have found a way—presumably an alloying process—to keep a very "hot" tape from literally burning itself up. And "hot" is an understatement. The tape, which 3M has dubbed Metafine, is reported to provide an increase in recording headroom (or signal-to-noise ratio, if you prefer) of between 6 to 12 dB over anything now available, at *all* audio frequencies. The potential here is a little unsettling, to say the least.

The company originally viewed Metafine as a video-tape product; but when its phenomenal retentivity characteristics became apparent, the temptation to really rock the audio-tape market was a

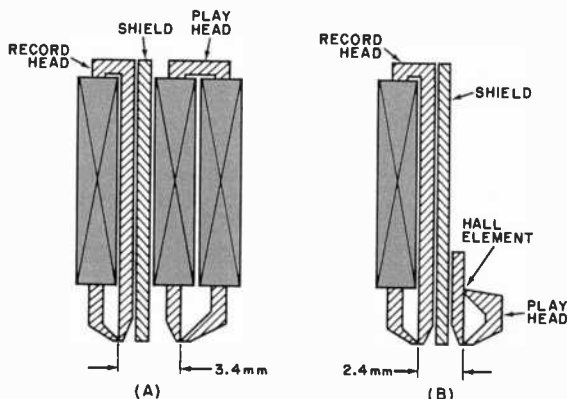

*Comparison of a Hall-head assembly for a three-head cassette deck (B) with the conventional heads (A) presently used by Hitachi.*



# NOW, SCANNING OVER 6000 FREQUENCIES IS AS EASY AS USING A PUSHBUTTON PHONE.



Introducing the incredible, new Bearcat 210.

The exciting, new Scanner Radio with the space-age, computer control center that brings in every available public service frequency with pushbutton ease.

Bearcat's new 210 is as easy to program as a pushbutton phone. You can select any of the public service bands (all the available local frequencies) simply by pushing buttons.

Simply punch in the frequency numbers on the computer control center keyboard. Hit the Enter button. And you're programmed.

A large, flashing, digital readout panel shows you each frequency you've selected.

The Bearcat 210 patented search capacity lets you explore the endless world of every available public frequency out there, too.

Best of all, you're no longer limited to a given band or set of frequencies. The new Bearcat 210 is synthesized. Space-age circuitry lets you forget crystals forever.

Let's look at some Bearcat 210 features. And facts.

**5 BAND COVERAGE**—Includes Low, High, UHF and UHF "T" public service bands, the 2-meter amateur (Ham) band, plus other UHF frequencies.

**SCANS 20 CHANNELS PER SECOND**—In half a second, the Bearcat 210 scans all 10 channels.

**CRYSTAL-LESS**—Space-age circuitry with 5 custom designed chips. You never have to buy a crystal.

**TRACK-TUNING**—Patented track tuning provides full-band coverage on every band.

**AUTOMATIC LOCK-OUT**—Locks out channels and "skips" frequencies not of current interest.

**AC/DC**—Mobile mounting bracket included.

**SELECTIVE SCAN DELAY**—Adds a two-second delay to prevent missing transmissions when "calls" and "answers" are on the same frequency.

**AUTOMATIC SEARCH**—New, patented feature searches out any active local public service frequency automatically. For more police, fire, marine, emergency calls. And much more.

## THE NEW BEARCAT 210

THE MOST EXCITING THING THAT'S HAPPENED  
TO SCANNING SINCE SCANNERS.

Electra Company  
300 East County Line Road, South, Cumberland, Indiana 46229  
Copyright 1977 Masco Corporation of Indiana

# No other TV/Audio home study school puts prices in its ads. Why?

## Maybe it's because they can't match these values.

No other school gives you a choice of five ways to learn TV/Audio servicing, with complete courses starting as low as \$445 and convenient, inexpensive time payment plans. No other school includes both an engineered-for-training 25" diagonal color TV and a four-speaker Quadraphonic stereo in its best course. In fact, to even match this kind of thorough training at another school, you'd have to take an extra course costing hundreds of dollars more. We're proud to quote our prices because we believe you get top educational value from NRI.

### **You pay less because NRI passes its savings on to its students.**

NRI pays no salesmen. We buy no outside "hobby kits" for our experiments or training kits. We design our own equipment with special Power-On features that allow you to experiment as you build. You get low tuition rates without the penalty of exorbitant interest charges for time payments. We pass the savings on to you.

### **More than 1 million students have come to NRI for home training.**

Home study isn't a sideline with NRI. We've been its innovating leader for

over 62 years. More than one million students have enrolled in our many career courses. NRI is one of the few home study schools with a full-time staff of engineers, authors and editors to help you with any problem. NRI graduates will tell you: you can pay more, but you can't buy better training.

### **Widest choice of courses with digital computer, CB, and complete communications.**

Send for the free NRI electronics catalog and check out the full spectrum of courses available, including Color TV, FCC License, Complete Communications Electronics—with Citizens Band radio, Computer Electronics, Marine and Aircraft Electronics, Mobile Communications, etc.

### **Mail the card for your Free NRI catalog.**

No salesman will call.



**NRI SCHOOLS**  
McGraw-Hill Continuing Education Center  
3939 Wisconsin Avenue,  
Washington, D.C. 20016

Available for career study under GI Bill  
Check the GI Bill Box on the card for information.

1  
2  
3  
4  
5

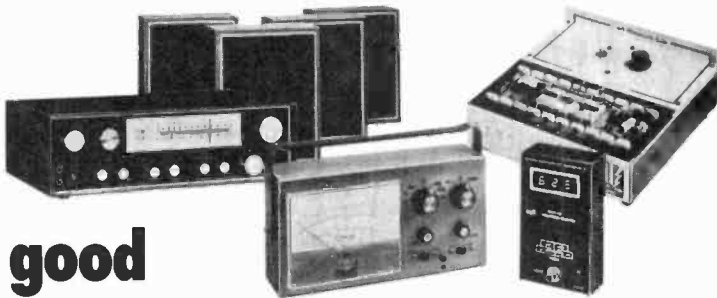

**good**



**better**



**better yet**



**best**



**advanced**

## 7 kits: Quadraphonic Stereo...

**\$445** or low monthly terms

A basic TV/Audio Servicing Course including 7 training kits for your experiments. You build your own 4-speaker Quadraphonic System, solid-state volt-ohmmeter, CMOS digital frequency counter, and electronics Discovery Lab. Includes 48 bite-size lessons (18 on color TV), 10 special reference texts with hundreds of servicing shortcuts, tips on setting up your own business, etc. This completely up-to-date course covers black & white and color TV, FM multiplex receivers, public address systems, antennas, radios, tube, transistor and solid-state circuits.

## 11 kits: Quadraphonic Stereo and B/W TV...\$550

or low monthly terms

A complete course in B&W and Color TV Servicing, including 48 lessons (18 on color TV) 10 special reference texts and 11 training kits. Kits you build include 4-speaker Quadraphonic System, solid-state volt-ohmmeter, CMOS digital frequency counter, electronics Discovery Lab, plus a 12" diagonal solid-state black & white portable TV to build and use. At each assembly stage, you learn theory and "Power-On" application of that theory in typical solid-state TV sets.

## 11 kits: 19" diagonal Color TV...

**\$880** or low monthly terms

The course includes 42 lessons and 4 reference texts plus kits and experiments to build a superb solid-state 19" diagonal color TV receiver... complete with cabinet, and engineered specifically for training by NRI's own engineers and instructors. This handsome set was designed from the chassis up to give you a thorough understanding of circuitry and professional troubleshooting techniques. You build your own solid state volt-ohmmeter, CMOS digital frequency counter, and experimental electronics Discovery Lab.

## 14 kits: 25" diagonal color TV and Quadraphonic Stereo...\$1195.00

or low monthly terms

The ultimate home training in Color TV/Audio servicing with 48 bite-sized lessons, 10 reference texts, and 14 training kits... including kits to build a 25" diagonal color TV, complete with console cabinet; a 4-speaker Quadraphonic Center; a wide band, solid-state, triggered sweep, service type 5" oscilloscope; digital integrated circuit color TV pattern generator; a CMOS digital frequency counter, and an electronics Discovery Lab. This gives you thorough TV and Audio training for hundreds of dollars less than the separate courses you'd have to take elsewhere.

This Master Course combines theory with practice, using the "Power-On" stages for experimentation and learning. Building NRI's equipment will give you the confidence and ability to service any color TV or Audio unit on the market. And you'll have a magnificent TV and quad unit for years of trouble-free performance.

## Pro Color: 19" diagonal color TV...

**\$665** or low monthly terms

An advanced Color TV Servicing Course for experienced technicians, 18 lessons, 5 new "Shop Manuals", and NRI 19" diagonal Color TV receiver with cabinet.



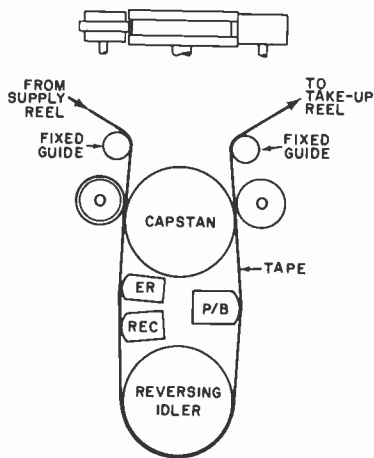

The 3M Iso-loop with tape's view of capstan and pinch-roller configuration at the top.

bit too hard to resist. Consequently there now exists—in prototype form—a Metafine cassette tape. Of late it has been made available to tape-machine manufacturers for their confidential evaluation and feedback, and rumor has it that similar tapes from Maxell and TDK are undergoing the same process.

Of course, there are a few things about Metafine that will take some getting used to. For example, its coercivity is on the high side of 1,000 oersteds, or roughly twice that of chromium dioxide.

This will call for a bias current approaching the strength of the erase current used in some consumer tape decks. 3M estimates there might perhaps be one tape machine presently on the market (whether professional or consumer was not specified) capable of delivering that kind of bias through to its record head. As for the rest of the machine population, the anticipated problems with tape-head saturation and even excessive head temperatures are obvious. Evidently we'll all need new tape machines to cope with recording Metafine and other tapes of its kind. In the meantime, wouldn't Metafine make a really superb prerecorded tape?

**Transports.** Chances are that the tape-transport mechanism on your open-reel tape machine looks pretty much like mine: supply reel to port, take-up reel to starboard, heads in the middle (with the capstan and pinch roller just to the right), and tape guides or tension arms here and there. Not all audio tape recorders look like this. The 3M Iso-loop transport, invented years ago by tape pioneer John Mullin and still enjoying immense popularity in professional recording studios, is a marvel of simplicity by comparison.

A large central capstan and two pinch

rollers are used. The left-hand pinch roller seizes the tape and propels it downward around a roughly rectangular head nest. As the tape comes up again, the right-hand pinch roller takes hold and sends the tape out in the direction of the take-up reel. Both pinch rollers contact the same capstan, and hence there's not the battle over which capstan will "win" that you find in some dual-capstan designs. The capstan and the left pinch roller are gently "stepped" in profile, providing two effective diameters. The left pinch roller contacts the inner diameter of the capstan, while the right pinch roller rides on the outer capstan diameter. The resulting differential in surface velocity controls tape tension across the heads quite precisely, and the whole concept makes for an absolute minimum of unsupported tape in the head region. I never expect to hear a user of an Iso-loop transport complain of scrape flutter or other unsupported-tape problems.

It nearly brought tears to my eyes to visit 3M some weeks ago and find numerous Iso-loop transports designed for ¼-inch tape in constant use, and none of them available to the consumer. But there's a bit of consolation to be had in the fact that, last year, Technics/Panasonic introduced the RS-1500US, a machine whose transport is the Iso-loop

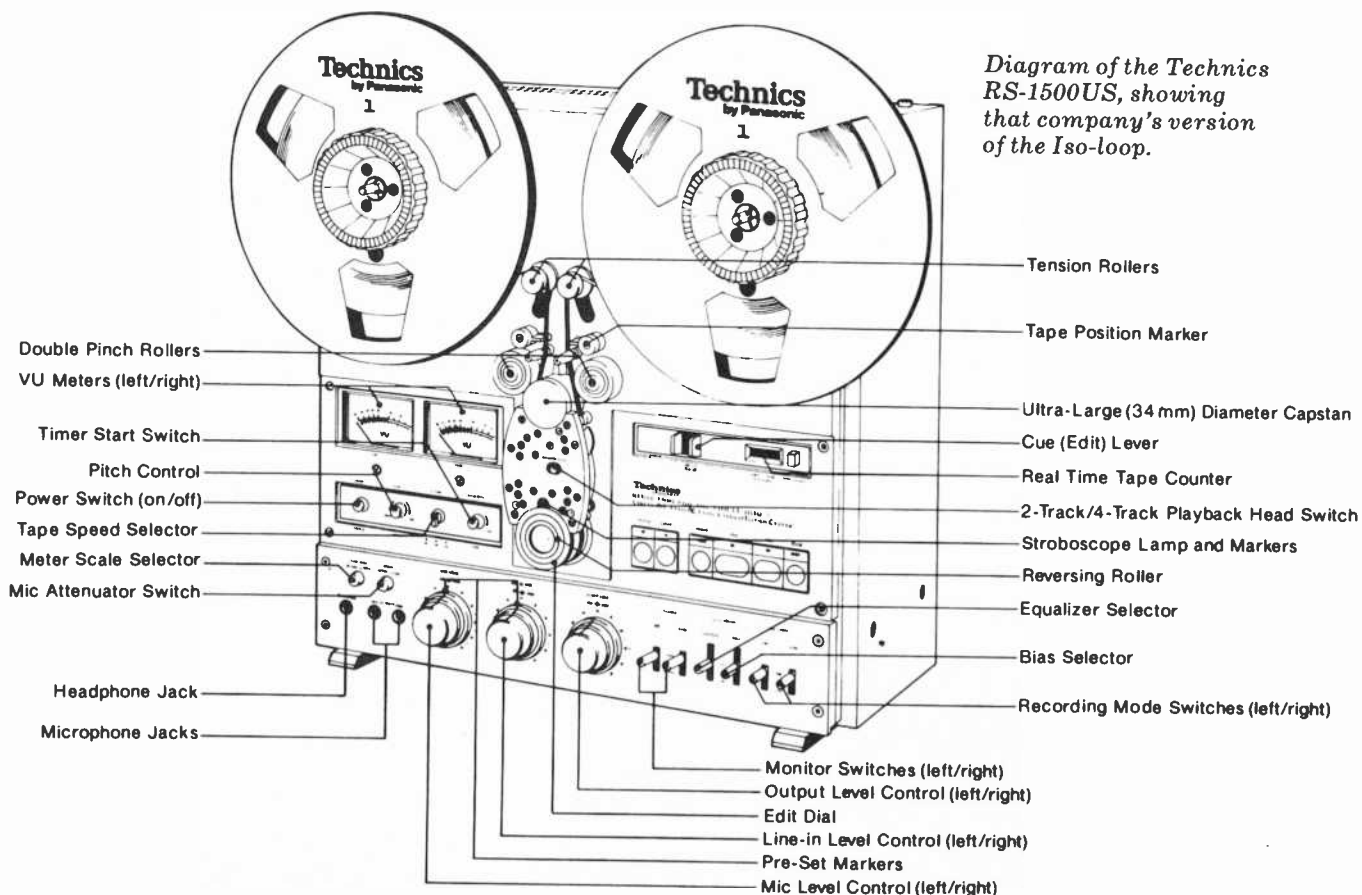

Diagram of the Technics RS-1500US, showing that company's version of the Iso-loop.



**Some guys rely on their 2-way radios more than others.**

Fighting a fire takes tough men. And tough equipment. Equipment like the Motorola® 2-way radios carried by so many fire fighters.

Today you can own a 2-way radio with many of the engineering principles that go into Motorola professional radios.

You can own a Motorola CB.

Features like gain control, audio compression, and noise limiting are built in, fully automatic.

So a Motorola CB is exceptionally simple to operate. Yet offers outstanding talk/listen performance.

A top-fire 3½-inch professional-quality speaker produces an audio fidelity that must be heard to be fully appreciated.

A power mic that doesn't require batteries, that doesn't cost extra, is standard equipment.

When you've made 2-way radios as long as Motorola, the result is a radio with a difference you can hear.

Whether you're fighting a fire. Or fighting the traffic home.



## Motorola CB

From the voice of experience in 2-way radio.

To find the dealer nearest you, write: Customer Relations Manager, Motorola Inc., Automotive Products Division, 1299 East Algonquin Rd., Schaumburg, Illinois 60196. Motorola is a registered trademark of Motorola Inc.

CIRCLE NO. 37 ON FREE INFORMATION CARD

AmericanRadioHistory.Com



# You gotta shop around.

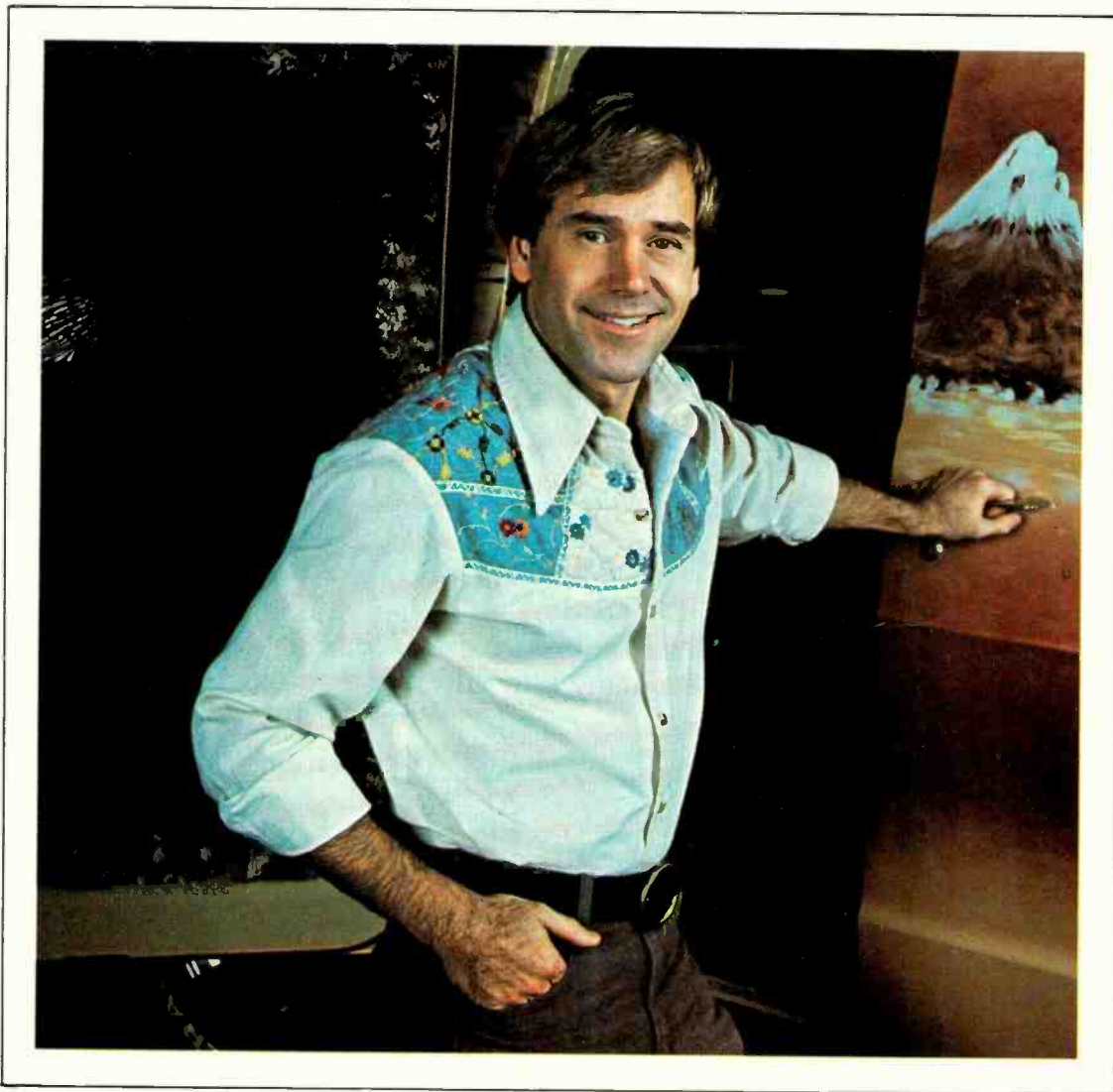

**When you do, you'll probably pick CIE.  
You can't afford to settle for  
less when it comes to something like  
electronics training that could  
affect your whole life.**



**W**hen you shop around for tires, you look for a bargain. After all, if it's the same brand, better price — why not save money?

Education's different. There's no such thing as "same brand." No two schools are alike. And, once you've made your choice, the training you get stays with you for the rest of your life.

So, shop around for your training. Not for the bargain. For the best. Thorough, professional training to help give you pride and confidence.

\* \* \*

If you talked to some of our graduates, chances are you'd find a lot of them shopped around for their training. They pretty much knew what was available. And they picked CIE as number one.

### Why you should shop around yourself.

We hope you'll shop around. Because, frankly, CIE isn't for everyone.

There are other options for the hobbyist. If you're the ambitious type — with serious career goals in electronics — take a close look at what we've planned for you at CIE.

### What you should look for first.

Part of what makes electronics so interesting is it's based on scientific discoveries — on ideas! So the first thing to look for is a program that starts with ideas and builds on them!

That's what happens with CIE's Auto-Programmed® Lessons. Each lesson takes one or two principles and helps you master them — before you start using them!

### How practical is the training?

This is the next big important question. After all, your career will be built on what you can do — and on how well you do it.

Here are ways some of CIE's troubleshooting programs help you get your "hands-on" training...

**With CIE's Experimental Electronics Laboratory...**

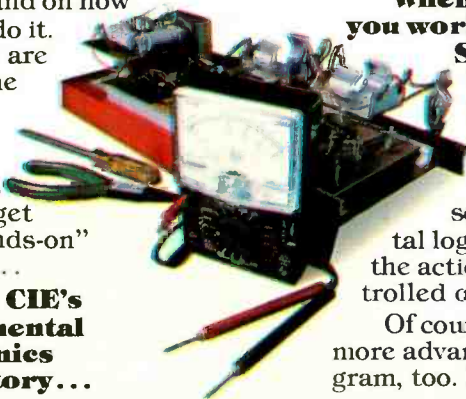

you learn and review the basics — perform dozens of experiments. Plus, you use a 3-in-1 precision Multimeter to learn testing, checking, analyzing!



**When you build your own 5 MHz Triggered-Sweep, Solid-State Oscilloscope** you take your first real professional step. You use it as a doctor uses an X-ray machine — to "read" waveform patterns... lock them in... study, understand and interpret them!

**When you get your Zenith 19-inch Diagonal Solid-State Color TV** you

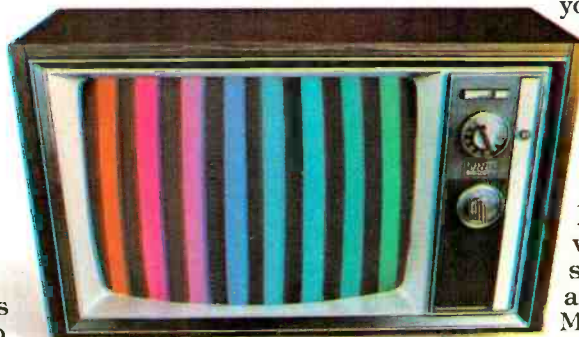

Pattern simulated.

apply your new skills to some real on-the-job-type troubleshooting! You learn to trace signal flow... locate malfunctions... restore perfect operating standards — just as with any sophisticated electronics equipment!

**When you work with a completely Solid-State Color Bar Generator** — actually a TV signal transmitter — you study

up to ten different patterns on your TV screen... explore digital logic circuits... observe the action of a crystal-controlled oscillator!

Of course, CIE offers a more advanced training program, too. But the main point is



simply this:

All this training takes effort. But you'll enjoy it. And it's a real plus for a troubleshooting career!

### Do you prepare for your FCC License?

Avoid regrets later. Check this out before you enroll in any program.

For some troubleshooting jobs, you must have your FCC License. For others, employers often consider it a mark in your favor. Either way, it's government-certified proof of specific knowledge and skills!

More than half of CIE's courses prepare you for the government-administered FCC License exam. In continuing surveys, nearly 4 out of 5 CIE graduates who take the exam get their Licenses!

### Shop around... but send for CIE's free school catalog first!

Mail the card. If it's gone, cut out and mail the coupon. If you prefer to write, mention the name and date of this magazine. We'll send you a copy of CIE's FREE school catalog — plus a complete package of independent home study information! For your convenience, we'll try to have a representative contact you to answer your questions. Mail the card or coupon — or write: CIE, 1776 East 17th St., Cleveland, OH 44114.

## CIE Cleveland Institute of Electronics, Inc.

1776 East 17th Street, Cleveland, Ohio 44114  
Accredited Member National Home Study Council

**YES... I'm shopping around for the right kind of career training in electronics troubleshooting — and CIE sounds well worth looking into. Please send me my FREE CIE school catalog — including details about troubleshooting courses — plus my FREE package of home study information!** PE-40

Print Name \_\_\_\_\_

Address \_\_\_\_\_ Apt. \_\_\_\_\_

City \_\_\_\_\_

State \_\_\_\_\_ Zip \_\_\_\_\_

Age \_\_\_\_\_ Phone \_\_\_\_\_

(area code)

Check box for G.I. Bill information:

Veteran  Active Duty

**Mail today!**

# If your cartridge is more than three years old, don't replace your stylus!

Don't get us wrong. There is nothing worse than playing your records with a worn stylus. And no better way to restore your system to its original glory than a new demand.

But frankly, there have been significant strides made recently in the phono cartridge field. And the new cartridges of today stand head and shoulders above even the finest of a few short years ago.

Here's the choice: Get fresh—but outdated—performance with a replacement stylus, or enjoy all the benefits of modern cartridge research and development for just a few dollars more. You'll find that you can update your system for far less than you might imagine. It's probably the most dramatic single improvement you can make.

For instance, Audio-Technica offers Universal™ cartridges equipped with a genuine Shibata stylus and our uniquely effective Dual Magnet™ system beginning at just \$75.00 list. Or you can replace your present cartridge with a fresh new Audio-Technica cartridge with highly-polished elliptical tip for as little as \$45.00 list.



AT11E	AT123a	AT1CEa	AT15Sa
\$45.00	\$75.00	\$65.00	\$125.00

Are these new models worth the difference? Absolutely. You'll be amazed at what you hear from today's generation of phono cartridges. Improved frequency response. Lower distortion. Better separation. Less record wear. Truly better sound.

**A new Audio-Technica cartridge.**  
Your best value in hi-fi.



**audio-technica**  
INNOVATION ◻ PRECISION ◻ INTEGRITY

AUDIO-TECHNICA U.S., INC., Dept. 87P, 33 Shilawassee Avenue, Fairlawn, Ohio 44313  
Available in Canada from Superior Electronics, Inc.

(except that pinch rollers of different hardness composition are used instead of the stepped pinch roller and capstan arrangement). As far as I can tell from my brief experience with the Technics deck, the trick of creating tape tension across the heads with hard and soft pinch rollers works reliably, but I regret that I have no firm numbers to report.

The trend of the moment, of course, is to eliminate pinch rollers entirely, a goal being pursued in the professional field by Ampex (the ATR-100) and in the consumer area by Uher with its recently introduced Omega drive. The benefits of pinch-rollerless drive are difficult to describe in a few sentences, so the subject is best put aside until the time when the trend is more fully established. However, be aware that it seems to be the coming thing.

**PCM.** But once again, who cares about sophisticated tape transports if he can have a nonanalog recording system that pays no attention to speed irregularities? Pulse-code modulation (PCM), although not a digital recording technique in any strict sense, is independent of recorded signal strength (and hence tape noise). It is also potentially independent of tape-speed irregularities.

It consists of a series of uniform-amplitude pulses (on tape or any other recording medium) that define the analog signal originally picked up by the microphones. They are "metered" by an electronic clock in the playback system to eliminate any time errors. So far as I know, there is no standard "code" to which audio PCM systems adhere. Duration and spacing of the pulses are the data that the recording generally provides, and these variables are "interpreted" as the designer of the overall system sees fit.

Don't look now, but consumer PCM recorders are virtually right on top of us. Sony has announced an adapter for the Betamax video-cartridge deck that will convert it into an audio PCM recorder. Another highly esteemed tape-machine manufacturer (I'm not free to name names just now) has halted all work on its latest open-reel creation to convert it to PCM. The conviction here is that PCM is the only possible (immediate) future for tape, and that a properly designed conventional audio recorder can do the job quite nicely, thank you.

It's apparent from the foregoing that tape recording, after these four imminent developments have materialized, will never be the same again. So let's gird our loins for the onslaught. ◊



Powerful in computing muscle, yet small in physical size, the Altair™ 680b offers many special features at an affordable price. Based on the 6800 microprocessor, the 680b comes with 1K of static RAM, Serial I/O port, PROM monitor and provisions for 1K of PROM as standard components. It's good thinking, when you're interested in making a modest investment on a highly reliable computer, to consider the Altair 680b.

Our PROM monitor eliminates the necessity for toggling front panel switches to load bootstraps or manipulate memory contents. Only a terminal and programming language are required for complete system operation.

With Altair System software—Altair 680 BASIC, assembler and text editor—you may begin problem solving immediately with ease.

By adding the 680b-MB Expander card, many options are currently available:

\*16K Static Memory Board—Increase your system memory with 16K bytes of fast access (215 ns), low power (5 watts per board) static RAM. 680 BASIC and assembler/text

editor are included free with purchase.

\*Process Control Interface—A PC card that uses optically isolated inputs and relay outputs that transmit sensory information to and control signals from the computer. A diverse world of control applications is opened up with the Altair 680b-PCI.

\*Universal Input/Output Board—If your I/O needs exceed the serial port already on the main board, augment your I/O channels with the 680b-UI/O. By implementing the optional serial port and two parallel ports, you can simultaneously interface to four terminals.

\*New Addition—Kansas City Audio Cassette Interface—Use the 680b-KCACR to interface your Altair 680b with an audio cassette recorder for inexpensive mass storage of programming languages, programs and data.

Available in either full front panel or turnkey models, the Altair 680b presents many computing capabilities at a low cost—without skimping on performance. See it today at your local Altair Computer Center or contact the factory for further details.

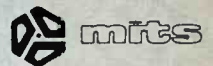
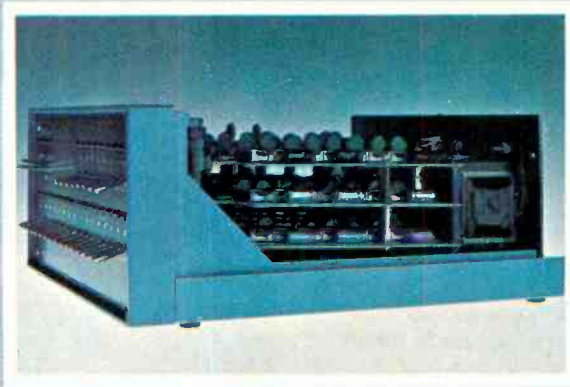

## Good Thinking.



2450 Alamo S.E. Albuquerque, New Mexico 87106  
dealer inquiries invited.

CIRCLE NO. 36 ON FREE INFORMATION CARD



# We've just made the impossible... a professional 3½ digit DMM Kit for less than \$60.



The Sabtronics Model 2000 is an impossible \$59.95! And that price still includes phenomenal accuracy, range and professional features.

This all-new bench/portable multimeter, reading to ±1999, has a basic accuracy of 0.1% ± 1 digit, and has five functions giving 28 ranges, 100% overrange and overload protection. So you know it's no toy!

Besides, what toys are as automatic as the 2000? With automatic overrange indication, automatic polarity, even automatic zeroing!

Yet the 2000 is easy to assemble. We send you all the parts you need, even the high-impact case. We also send you clear, step-by-step assembly instructions.

So you end up with a professional quality 3½ digit DMM for the unheard-of price of less than \$60. From Sabtronics, specialists in digital technology. And manufacturers of the impossible.

Order yours today!



Made in U.S.A.

## sabtronics

INTERNATIONAL INC.

P.O. Box 64683 Dallas, Texas 75206 (214) 369-7310

### GUARANTEE:

Our guarantee to you; examine the 2000 DMM kit for 10 days. If you're not satisfied, return it unassembled for a full refund of purchase price.

### SPECIFICATIONS: (condensed)

DC volts in 5 ranges: 100µV to 1000V.  
AC volts in 5 ranges: 100µV to 1000V.  
DC current in 6 ranges: 10nA to 2A.  
AC current in 6 ranges: 10nA to 2A.  
Resistance in 6 ranges: 1Ω to 20MΩ.  
Input Impedance: 10MΩ.  
Display: 9mm (.36") LED.  
Power requirements: 4.5 VDC to 6.5 VDC (4 "C" cells - not included).  
Size: 8"W x 6.5"D x 3.0"H.  
(203W x 165D x 76H mm).

To: Sabtronics International, Inc.  
P.O. Box 64683, Dallas, TX 75206

PE8

Please send me \_\_\_\_\_ Sabtronics Model 2000 DMM kit(s) at \$59.95 each. \_\_\_\_\_ subtotal

Shipping and Handling, \$5.00 per unit\* \_\_\_\_\_ subtotal

Texas Residents Add Sales Tax \_\_\_\_\_

TOTAL enclosed \_\_\_\_\_

Name \_\_\_\_\_

Street Address \_\_\_\_\_

City \_\_\_\_\_

State \_\_\_\_\_ Zip \_\_\_\_\_

\*USA only. Canada, \$6.50 All Other Countries, \$10.00



## Audio Reports

### IS THERE A DIGITAL FM TUNER?

In recent years, several FM tuners and receivers have been acclaimed as being “digital” components. In this context, “digital” is a catch-word that (with apologies to Lewis Carroll) usually means just what its writer intends it to mean; no more, and no less.

The most obvious external feature of a digital tuner is its frequency display, which is usually the only digital feature it has. Instead of a tuning dial calibrated with an accuracy that may range from the barely acceptable to the unusable, the tuner frequency is displayed via glowing digits to the nearest 0.1 MHz (or 10 kHz on AM, if that feature is included). In its simplest form, a digital FM tuner uses a frequency counter to measure its local oscillator frequency, subtract 10.7 MHz, and display the difference. Such a tuner (the Heath Model AR-1515 receiver, reviewed in this issue, is a good example) still requires a tuning meter as an aid to finding the exact center of the channel, since the digital display cannot resolve closer than 100 kHz. Normally the display blanks out “even” numbered channels (for example, it will go directly from 96.1 to 96.3 MHz) since all channel assignments in this country are on “odd” frequencies.

The advantages of the counter-type frequency display to the user are its improved accuracy and visibility at a distance. The designer’s job is easier because he does not need a linear tuning characteristic, or even any sort of reproduceable tuning characteristic. However, the same stability and overall tuning ease are required as for any ordinary tuner.

Another type of digital tuning system uses a frequency synthesizer instead of a free-running oscillator. As a rule, a phase-lock loop (PLL) locks the local oscillator to a stable crystal oscillator. The PLL is an analog circuit, but considerable digital circuitry is required in the frequency dividers that reduce the frequency of the local oscillator to where it can be compared with the reference signal. And, of course, this type of tuner has digital counter and display circuits as well (although this function could be handled easily by several selector switches like those used to select channels on 144-MHz Amateur FM transceivers).

A synthesized tuner behaves quite differently from one that has a free-running oscillator with a frequency counter display. The synthesized signal moves in discrete steps, usually 200 kHz in this country. (Some European synthesized tuners use 50-kHz steps to accommodate the channel assignments used there.)

A tuning meter is not required, since the oscillator frequency is generated—and known—with far more accuracy than could be achieved by any manual tuning means.

A synthesizer can be programmed to generate any frequency within its range. The most striking example of this (and still the only unit of its kind) is the Heath Model AJ-1510A FM tuner. Any frequency in the FM band can be selected by sequentially pressing the calculator-type keys on its panel. This tuner and some others made in past years also can be programmed with punched cards to go immediately to the selected frequency when a card is inserted in a slot in the panel. (Heath’s tuner can hold three cards, which can be selected by push buttons.) For scanning a band of frequencies, synthesized oscillators can be swept electronically (in discrete steps, although this is not obvious to the user), or tuned electrically by a conventional knob. The Revox tuner covers the FM band in 50-kHz steps as its knob is rotated, as an example.

The next step up in digital complexity is the use of a microprocessor in a tuner. So far, the only such application we know of is in a new “super tuner” announced by Sherwood but not yet available for sale at this writing. Not only the frequencies, but the call letters, of selected stations can be made to appear on its alphanumeric display. We will undoubtedly see other, even more imaginative, applications of digital circuitry to tuner displays in the near future.

Of course, none of these novel and intriguing applications of digital electronics to FM tuners affect its sound. And since they all add to the cost, one is spending a portion of the product’s cost for cosmetic appeal in many cases, and for repeatable tuning accuracy in other instances.

Are there any actual digital circuits used in the functional portions of the tuner? There are a few easily overlooked ones because they are within a single circuit block or IC chip whose function is basically analog. In a multiplex demodulator, for example, there are frequency dividers to produce 38- and 19-kHz signals from a 76-kHz voltage-controlled oscillator (vco). For that matter, digital techniques have been used for decades in FM detection to give the greatest linearity. The discriminator, or ratio detector, is one of the sources of distortion in an FM tuner. It should be perfectly linear, with a voltage output proportional to signal frequency. Any nonlinearity

creates distortion in the audio signal from the tuner. Most discriminators depend on a resonant circuit for their operation. This circuit can be linear over only a limited band of frequencies and never perfectly linear from a theoretical standpoint.

For many years, the counter-type detector has been recognized as the most linear form of FM demodulator. In the ideal case, it would generate a single very-short pulse of constant width and amplitude every time the incoming signal waveform crosses the zero-voltage axis. The average value of these pulses, emerging in a train from the detector, is proportional only to the number of pulses occurring in a unit of time (that is, to the frequency of the incoming signal). Since the pulse amplitude is also independent of the signal amplitude, this type of detector is also an effective limiter.

In practice, a true counter detector is too expensive to use in a consumer-type FM tuner, although it is found in some laboratory instruments. Less expensive versions have been developed, some of which are found in recent products from Sherwood and Heath (the Heath AR-1515 has such a detector).

Another digital circuit in an FM tuner is in its interstation noise muting system. This is literally a "go/no-go" circuit that responds to one or more of the internal tuner parameters that depend on the presence, frequency, or strength of a signal. These include the

discriminator output and limiter voltages and high-frequency random noise in the detector output. In the more sophisticated muting systems, a logic circuit monitors all these voltages and passes the audio signals only when they indicate that a signal of receivable quality is in the tuner's pass band. The "digital" character of the final muting action may range from none at all (a gradual reduction of signal level with strength) to total (a reed relay that opens or shorts the audio).

Aside from these idealized examples, the very nature of FM reception is analog rather than digital. So when you read about a "digital" tuner, remember that this applies, at most, only to the generation of its local oscillator signal or, more probably, only to the display of its frequency. It is still less expensive to make an accurately calibrated tuning dial that's readable to 100 kHz than to incorporate a frequency counter into an FM tuner. Nevertheless, so few companies have ever made a serious effort to achieve "slide-rule" dial tuning accuracy (this is one tuner parameter that has absolutely no relationship to the selling price of the product) that we assume digital numeric displays will eventually take over this function. As dropping prices of digital IC's and display components eliminate the economic advantage of a tuning dial, we can expect digital tuner displays to become common at all price levels in a few years. ◇



## HEATH MODEL AR-1515 AM STEREO FM RECEIVER

*Complete integrated tuner/control center/amplifier has digital display.*



The Model AR-1515 AM/stereo FM receiver that tops Heath's hi-fi receiver lineup is

derived, at least in part, from the highly versatile Modulus introduced a couple of years ago. For example, both have digital numeric AM/FM frequency displays instead of a tuning "dial" and most circuits are built on swing-up, plug-in pc boards. (In fact, the optional FM Dolby decoder in both cases is identical.) Where the two differ is in the fact that the Model AR-1515 is a complete integrated tuner/control center/amplifier, while the Modulus is basically a tuner/control cen-

ter to which external power amplifiers must be added. The new digital receiver is rated to deliver a minimum of 70 watts/channel into 8 ohms with less than 0.08% THD from 20 to 20,000 Hz.

The Model AR-1515 receiver measures 21½"W × 15"D × 6¼"H (54.6 × 38.1 × 15.9 cm) and weighs 35.8 lb (16.3 kg). Available only in kit form, it is catalog priced at \$549.95. The optional Model AD-1504 FM Dolby decoder kit is \$39.95.

**General Description.** The numeric display is really what makes this a "digital" receiver. The ½" (12.7-mm) red LED seven-segment display indicates FM

frequencies to the nearest 0.1-MHz, displaying only the odd-numbered channels used in the U.S., and to the nearest 10-kHz on AM. The display and its decoder/driver circuits are located behind a rectangular "dial" area at the left of the front panel. The dial area is covered with a window that appears as a dead black area when the receiver is turned off.

Also behind the window are two meters that indicate relative signal strength on AM and FM and center-channel tuning on FM. The meters are lit in soft blue-green when the tuners are in use. Other illuminated legends that appear on the window identify the program source selected (AUX, TAPE, AM, FM, PHONO 1, and PHONO 2), the mode (MONO or 2CH), and the presence of a stereo FM PILOT during reception.

To the left of the dial window is the pushbutton POWER switch. When the power is on, no discrete power indicator comes on. Instead the numeric display lights up when the receiver is set to either tuner or at least one of the other legends is illuminated when the tuners are not selected to indicate the power-on status.

To the right of the dial window area



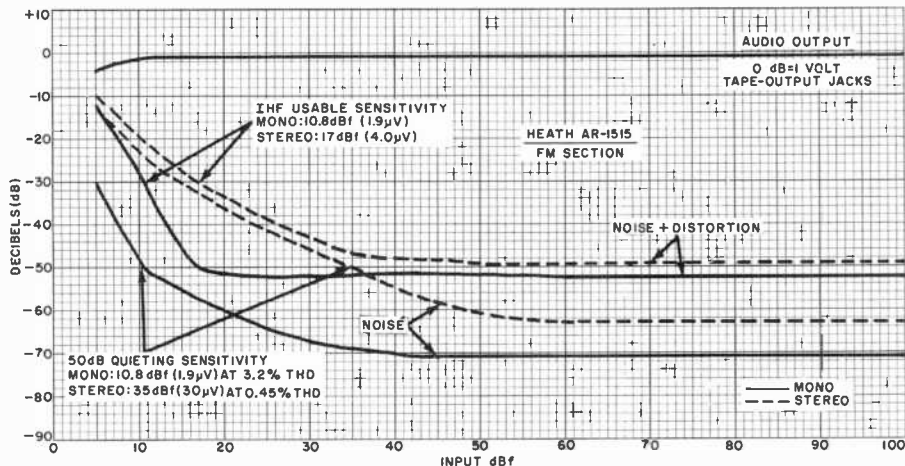

Noise and sensitivity curves for FM section of receiver.

are all the primary controls, arranged in a horizontal row. These include the TUNING control, MODE and source SELECTOR switches, and the VOLUME control. All less-frequently used controls are located along the lower portion of the front panel and hidden behind a narrow panel that hinges down to allow access to them. At the left is a headphone jack for private listening. This is followed by separate pushbuttons that switch in and out two sets of speaker systems. The next two buttons allow switching in and out LOW and HI audio filters. Next come three small controls, with knobs that are the same size and shape as those on the pushbutton switches. These are for adjusting the BASS, TREBLE, and BALANCE.

After the rotary controls come seven pushbutton switches: TONE FLAT bypasses the tone controls; LOUD compensates the response at reduced volume levels; SQUELCH DEFEAT; BLEND reduces noise on weak stereo FM signals; DOLBY for decoding Dolby-encoded FM broadcasts when the optional Dolby module is included; TAPE MON (monitor); and TAPE DUBBING. The TAPE DUBBING switch is used with the two TAPE DUBBING jacks located to its right. The jacks are labelled IN and OUT. They can be used to patch a second tape deck into the system (in addition to a deck connected to the terminals on the rear of the receiver). Programs can be dubbed from either deck to the other or copied on either or both decks from a selected program source.

The speaker outputs on the rear apron use Heath's proprietary polarized connectors that are designed to simplify installation and eliminate phasing errors. Since there are no markings on the plugs themselves, the "hot" and ground terminals can be identified only by ex-

amining the rear panel of the receiver, on which the polarities are plainly marked. (The plugs can go into the connector blocks in only one direction).

Among the input and output connectors provided are separate preamplifier-output and power amplifier-input jacks that are normally linked together by external jumpers. Vertical and horizontal outputs are also provided for using an oscilloscope as a multipath indicator. A 300- or a 75-ohm FM antenna can be hooked up to the receiver via screw-type terminals, while a phono jack is used for the shielded coaxial AM loop antenna used with the receiver. (Materials are provided in the kit for making the antenna.)

The power transistors and their large heat sinks are mounted on the sides of the receiver, flush with the rear apron. Wooden walnut-finished side panels decorate the sides between the heat sinks and front panel.

The FM tuner has a preassembled and tested front end containing two MOSFET r-f amplifiers and four tuned circuits. The oscillator frequency is divided by eight before being counted for display on the numeric frequency display. The FM i-f amplifier has two shielded LC

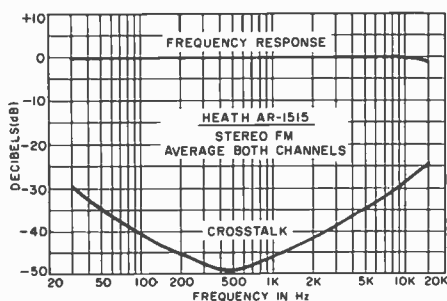

Frequency and crosstalk averaged for both channels.

filters, IC stages for gain and limiting, and an IC digital detector. The multiplex decoder uses a phase-locked-loop (PLL) IC.

**Laboratory Measurements.** Our test receiver was built from a kit and aligned in accordance with instructions without the use of external test equipment. Since we found that the measured performance of the receiver after assembly and alignment without instruments generally matched or surpassed its ratings, we did not attempt to make any improvements by instrument alignment.

After the one-hour preconditioning period at one-third rated power, the heat sinks were fairly warm but not uncomfortable to the touch. The rest of the receiver was quite cool. (In normal service, the hottest part of the cabinet is directly over the numeric display and its three IC drivers.) The outputs clipped at 78 watts/channel with both channels driving 8-ohm loads at 1000 Hz. The 4-ohm output was 122 watts, and the 16-ohm power was 59 watts.

The 1000 Hz THD was between 0.006% and 0.01% from 0.1 to 30 watts output. It increased to 0.014% at the rated 70 watts and to 0.017% at 75 watts. The intermodulation (IM) distortion was between 0.02% and 0.1% for all outputs from 20 mW to 75 watts output.

At the rated output into 8 ohms, the THD was about 0.015% in the midrange and less than 0.05% from 20 to 20,000 Hz. At half power and less, the characteristic was similar and the distortion remained between those limits. The input required for a 10-watt reference output was 55 mV through the AUX inputs and 0.63 mV through the PHONO inputs. The respective S/N measurements were 85 and 77 dB (unweighted), both of which are exceptional figures. The phono input overloaded at a very safe 125 mV.

The tone control characteristics were excellent, with the bass control turnover frequency shifting from well below 100 Hz to about 300 Hz as the control was moved from center and the treble response hinging at about 5000 Hz. Except at the extreme settings of the controls, the midrange response was hardly affected. The filters had the desirable (and rarely found) 12 dB/octave cutoff slopes, with their -3-dB response frequencies being 5000 and 22 Hz. The loudness compensation boosted both low and high frequencies to such a moderate degree that the feature was actually useful.

The RIAA phono equalization was as

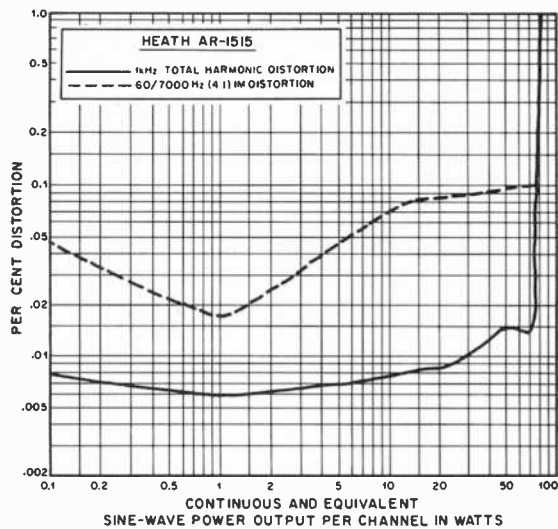

Total harmonic distortion and 60/7000-Hz distortion.

accurate as our test instruments could measure, with  $\pm 0.5$  dB from 25 to 20,000 Hz. It was immune to cartridge inductance, which changed the frequency response by less than 0.5 dB in the 10,000-to-20,000-Hz range. This is a result of the use of op-amps for the phono preamplifiers, which maintain good isolation between the signal input and the feedback components that determine the frequency response.

The FM tuner was as "hot" as any we have tested. The mono IHF sensitivity and 50-dB quieting sensitivity both measured 10.8 dBf (1.9  $\mu$ V). In stereo, the IHF sensitivity was 17 dBf (4.0  $\mu$ V), and the 50-dB quieting sensitivity was 35 dBf (30  $\mu$ V) with 0.45% THD. The ultimate THD at a 65-dBf (1000  $\mu$ V) input was 0.24% in mono and 0.34% in stereo. The respective S/N measurements were 70.5 and 63 dB. The stereo THD, with L - R modulation, was 1.1% at 100 Hz, 0.63% at 1000 Hz, and 0.07% at 6000 Hz.

The FM capture ratio of 1.7 dB was fair by current standards, though the 72-dB AM rejection figure was well above average. Image rejection was a very good 100 dB, and was barely within the range of our test equipment. Alternate-channel selectivity was also very good at 83.7 dB, and adjacent-channel selectivity was 11.8 dB. The muting threshold, as set by the kit builder, was at 21 dBf (6  $\mu$ V), which was a suitable setting for most purposes (the threshold is adjustable during the alignment of the receiver). Unlike most FM receivers, the AR-1515 does not automatically switch from stereo to mono when the signal strength drops below a certain level. If a stereo signal is heard with too much noise, the user has merely to set the MODE switch to MONO. This does not

affect the FM PILOT indicator on the panel, so that one is always aware that a transmission is in stereo, even if it is being heard in mono.

The FM frequency response was almost perfectly flat from 30 to 10,000 Hz and was down 1.4 dB at 15,000 Hz. The 19-kHz pilot carrier in the audio outputs was suppressed to -62 dB. FM tuner hum was -70 dB. Stereo crosstalk was about -47 dB at 400 Hz, increasing smoothly to -28 dB at 30 Hz and to -23.5 dB at 15,000 Hz. Both channels were identical in this respect, and the adjustment of the separation control on the multiplex board (its only alignment adjustment) was completely noncritical. When it is set so that the FM PILOT light comes on, the separation is automatically optimum. The only measurement made on the AM tuner was for frequency response, which (like that of the Heath Modulus) was excellent. It was within  $\pm 1$  dB from 20 to 4000 Hz, and down 6 dB at about 6600 Hz, after which it dropped off steeply to -30 dB at 10,000 Hz and beyond. (The usual AM "whistles" are effectively eliminated in this tuner.)

**User Comment.** Assembling the receiver was a time-consuming but by no means a difficult job. The kit builder spent some 41 hours assembling, checking out, and adjusting the receiver. An additional two hours were spent on assembling the tester that comes with the receiver and the optional Dolby noise-reduction module.

As usual, a great deal of credit must be given to Heath's excellent assembly manual and the use of wiring harnesses with prepared wire ends (including sockets for the pc modules) for the ease with which this kit went together. Each sub-

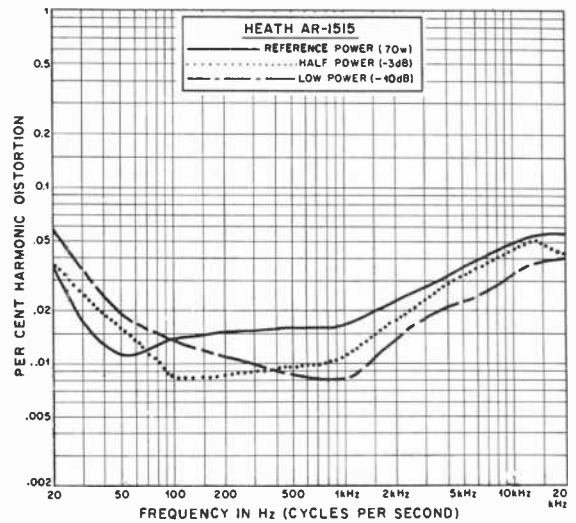

Harmonic distortion at three power levels.

assembly that makes up the receiver was packaged in its own box, which made the kit-building job appear more like an exercise in assembling a number of mini-kits. Too, the mechanical portions of the receiver seemed to fall into place, so easily did they line up and fasten together.

In many respects this receiver's performance is in keeping with the better manufactured receivers on the market today in its price range. In almost all other respects, the receiver would rank from good to excellent. Only in a couple of measurements did it fall short of what we have come to expect from an expensive, deluxe receiver. Judged by its actual off-the-air performance and sound quality, the receiver can hardly be faulted. Moreover, we know of no other stereo receiver that can match its AM quality.

The concept of an uncluttered front panel, with only the principal controls exposed to view, is an admirable one. Heath has come very close to achieving this goal in the AR-1515. It missed its full realization, however, by putting the MONO/STEREO switch on the main panel with a knob equal in size to the TUNING, VOLUME, and input SELECTOR controls.

The tuning rate is unusually fast. Only about five turns of the tuning knob are needed to cover the entire FM band. The actual "feel" of the tuning is very different from the freely-moving flywheel mechanisms of other tuners and receivers, but it is very smooth, positive, and

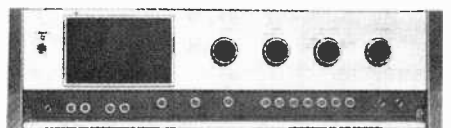

With hinged front panel open, minor controls and jacks are shown.

noncritical. The digital "dial" leaves no doubt as to which channel the receiver is tuned to, of course, and there is no detectable frequency drift, even from a cold start. The tuning is non-critical for optimum noise, distortion, and stereo separation characteristics, so that centering the tuning meter assures that the receiver is doing its best job. Interstation

FM muting is positive and noise-free, except for a slight "click" as it goes in and out of action. Also, this receiver is one of the very few to have really effective audio filters.

The AR-1515 receiver is certainly flexible enough for any reasonable listening situation and will easily hold its own with any receiver in sheer listening quality. If

the pleasure of building your own receiver is a factor, (it requires considerable time to assemble, but it goes together without a snag), this receiver represents a fine choice since the end result from both a performance and aesthetic view would make any builder proud to claim it as his handiwork.

CIRCLE NO. 90 ON FREE INFORMATION CARD

## THORENS MODEL TD-126C RECORD PLAYER

*Has low-mass tonearm and electronic belt-driven turntable.*



The new Model TD-126C high-performance record player from Thorens features

the company's very-low-mass "Isotrack" tonearm and an electronic belt-driven turntable. It is also one of the very few modern turntables to offer the 78-rpm speed as well as the more commonly available 33 1/3- and 45-rpm speeds. The platter and tonearm are isolated from the base on which the motor controls are mounted by a highly compliant spring suspension.

The record player is supplied on a black base with silver accents and comes with a hinged plastic dust cover. It measures 19<sup>7</sup>/<sub>8</sub>"W × 15<sup>1</sup>/<sub>2</sub>"D × 6<sup>3</sup>/<sub>4</sub>"H (50.5 × 39.4 × 17.1 cm) and weighs 34 lb (15.5 kg). Price is \$625. Additional plug-in tonearms are \$15.00 each.

**General Description.** The gimbal pivots support a 9" (23-cm) straight tubular lightweight aluminum tonearm. Antiskating compensation is applied by opposing magnetic fields and can be adjusted by turning a knob on the side of the pivot housing. Four antiskating scales cover the use of conical and elliptical styli on dry and wet (lubricated) record surfaces.

A large part of the effective mass of a

tonearm is in the plug-in cartridge shell and its locking hardware found in most record-player systems. Thorens has eliminated the usual cartridge shell with the result that the end of the tonearm contains only a plastic T that is just large enough to permit mounting a cartridge through its 1/2" (12.7-mm) spaced holes and a light metal finger lift

For cartridge installation and interchanging, the entire tonearm plugs into and unplugs from a socket that resembles the four-pin type used in most conventional tonearms at the cartridge shell end. The socket is located only about 2<sup>1</sup>/<sub>2</sub>" (6.35 cm) from the pivot, where its mass is much more tolerable than it would be if it were on the end of the tonearm. The removable tonearm (additional arms are available for installing other cartridges) is furnished in a plastic storage container that also serves as a jig for aligning and orienting the phono cartridge.

The 7-lb (3.2-kg) cast nonferrous platter is driven by a 16-pole synchronous motor. The speed of the motor is controlled by a stable Wein-bridge oscillator. A vernier control is provided for adjusting the speeds over a nominal ±6% range.

The controls for the turntable are located in a row across the top front of the base. The suspended portion of the rec-

ord player lies behind the controls so that operation of the controls does not jar the pickup. A knob at the left is for turning on and off the power to the turntable. The speed is selected by pressing lightly one of three flat rectangular plates. The outer edge of the selected speed plate lights up. (When the turntable is initially turned on, the 33<sup>1</sup>/<sub>3</sub>-rpm speed is automatically selected.)

To the right of the speed-selector plates is the stroboscope window that provides a view of the illuminated markings on the bottom of the platter. A speed vernier control near the window can be used to adjust each speed, referred to its own set of stroboscope markings. Although a single Vernier speed control is provided, when one speed is accurately set, the others are also correctly set. To the right of the vernier control is the mode selector that provides the user with a choice of fully manual operation, automatic tonearm lift at the end of play, or automatic tonearm lift and motor shutoff at end of play.

Next come three flat plates, similar to those used for speed selection. The first plate, whose edge lights up when power is first applied, is a shutoff control that, when activated, lifts the tonearm and removes power from the motor. The next plate turns on the motor but does not lower the tonearm; it can be used as a cueing arm lift when a record is being played. The last plate turns on the motor and lowers the pickup; it is the cueing descent control when a record is on the turntable. Very little force and almost no travel are required to activate any of the plate controls. For the automatic end-of-play tonearm lift, an electric velocity sensor detects the rapid movement of the tonearm in the eccentric groove and triggers the lift circuit. It does so without imposing any additional load on the tonearm or cartridge.

**Laboratory Measurements.** We tested the record player with a Shure Model M95ED cartridge installed in its tonearm. After adjusting the cartridge as accurately as possible with the plastic



storage container/setup jig, we found that the apparent tracking error was larger than we had expected it to be. Investigating further, we discovered that it was difficult to measure the tracking error with our stylus protractor because of the shape of the tonearm. (No cartridge shell surfaces are tangent to the record groove.) On the reasonable assumption that the almost constant 2° error that we found was a measurement problem rather than a true tracking error, we determined that the tonearm has a near zero error over most of the record surface and a maximum of 0.5°/in. near the outside of the record.

When we balanced the tonearm so that the stylus was just above the surface (this according to instructions), the tracking force was high by 0.25 gram at all settings of the pressure dial. We readjusted the balance for a correct reading with the force dial set to 1 gram and found that the calibration was accurate over the entire 0.5-to-3-gram range of the dial. However, the tonearm balanced with the stylus about 1/2" above the surface of the record.

When we measured the mass of the tonearm with a calibrated spring driven

by a small loudspeaker motor, it was 9.8 grams (after subtracting the 6-gram mass of the cartridge). Although this is somewhat more than the claimed 7.5-gram mass, it was substantially lower than the mass of a typical record player tonearm.

The low-frequency resonance of the M95ED cartridge in the Isotrack tonearm fell at 10 Hz instead of the 8 Hz or so that is typical of other tonearms. The capacitance of the tonearm's wiring and the integral signal cables was 190 pF/channel, which is suitable for stereo cartridges but obviously not intended for use with CD-4 cartridges.

The turntable rumble was a very low -42 dB in a lateral unweighted measurement and -64 dB with ARL weighting. Spectrum analysis revealed that the rumble was predominantly at 6 Hz. Although flutter was a low 0.035%, the wow varied at a slow rate, with a period of several seconds, between 0.02% and 0.08%, averaging about 0.06%. The principal flutter component was at 50 Hz.

The speeds of the turntable were exact and did not change with line voltage or with extended use. The vernier con-

trol had a measured range of ±9%.

The antiskating calibration was correct, giving equal distortion in both channels of the cartridge's output when the control was set to match the tracking force. However, when the antiskating was set to its minimum, there was sufficient residual force to swing the tonearm outward when it was floated in a balanced condition. The descent of the tonearm during cueing was slightly influenced by the antiskating force, causing it to drift outward enough to repeat a couple of seconds of the record.

The isolation of the record player from base-conducted vibrations was extremely effective. There was only one resonant transmission peak, between 40 and 50 Hz, and at this frequency, the sensitivity of the player to external vibration was 10 to 30 dB lower than any other record player we have tested. At other frequencies, the isolation was as much as 50 dB better than on other players. The self-resonant frequency of the player on its springs was about 3 Hz.

**User Comment.** The Model TD-126C record player represents an appreciable advance in player performance, even

# Circuits happen Faster and Easier with Super-Strip.™

As little as  
**\$17**

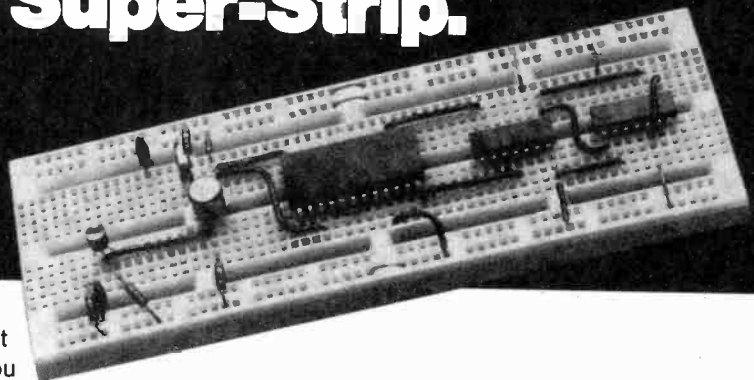

Now, whenever you'd like to give a circuit a try, you can build it up nearly as fast as you can dream it up with Super-Strips™, the faster, easier and less expensive solderless breadboards from A P Products. When you build your circuit on a Super-Strip, everything stays as good as new. Once you're through, you can use everything again and again. Instantly. Put a Super-Strip to work for you. Eight distribution lines handle signal and power, and 128 five-tie-point terminals can handle 9 ICs and then some. It's a whole lot easier than printing a circuit and a whole lot handier than haywire.

Part Number	Model Number	Terminal Type	Price Each
923252	SS-2	nickel-silver	\$17.00
923748	SS-1	gold-plated	\$18.90

**Order from your A P distributor today. Our distributor list is growing daily. For the name of the distributor nearest you call Toll-Free 800-321-9668.**



Send for our complete A P catalog, the Faster and Easier Book.

**A P PRODUCTS INCORPORATED**

Box 110 Painesville, OH 44077 (216) 354-2101 TWX: 810-425-2250

though most of its basic design features are conventional. Most important is that its tonearm mass is the lowest by far that we have measured on a conventional record player (with a pivoted offset arm). The antiskating is correct, which is most unusual in our experience. Turntable flutter is low, though not unusually so, but the rumble is on a par with some of the best direct-drive turntables and is lower than we have previously measured on a belt-driven turntable. And as we mentioned before, this is also one of the very few modern turntables to offer a 78-rpm speed.

The operation of the player is simple and logical, providing a choice of partial automation or none at all. For all practical purposes, the player is immune to acoustic feedback conducted through its base. However, the player was somewhat sensitive to jarring under rough handling.

To counterbalance its virtues, the player is large, heavy, and quite expensive. It is obviously not suited to CD-4 cartridges, and it does not have a perfectly drift-free cueing system (though it is no worse in this respect than most other players).

Cartridge installation was an incredibly exasperating procedure, we observed. Fortunately, this is not a recurring process. Perhaps our reaction is colored by having read the manufacturer's instruction manual before starting. The importer's manual is relatively clear on the cartridge installation procedure.

In sum, even at its rather high price, the Model TD-126C record player is certain to appeal to discriminating phonophiles, especially those who have collections of 78-rpm discs.

CIRCLE NO 102 ON FREE INFORMATION CARD

## ORTOFON MODEL MC20 PHONO CARTRIDGE AND MODEL MCA-76 PREAMPLIFIER

*Top-grade stereo cartridge uses moving-coil design.*

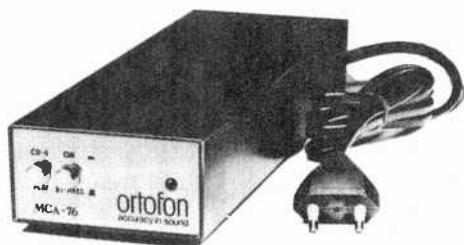
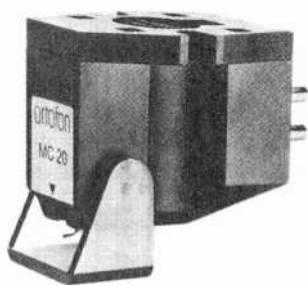

Ortofon has recently produced some moving-iron cartridges, but its newest and finest

model, the MC20, uses the moving-coil principle, which they had previously employed exclusively. As is the case with most moving-coil cartridges, this one does not allow user replacement of the stylus. Instead, the entire cartridge can be exchanged for a new one at a considerable price saving when it comes time to replace the stylus.

Since the moving-coil type of cartridge has a very low output level, it usually requires a signal "booster" to allow it to adequately drive the phono input circuits of most amplifiers and receivers. This booster can be a step-up transformer or a separate preamplifier, both of which are available from Ortofon. For our tests on the Model MC20 cartridge, we selected the new Model MCA-76 preamplifier.

The Model MC20 cartridge is priced at \$120 (\$65 on exchange for stylus replacement); the Model MCA-76 preamplifier is \$170.

**General Details.** A modified elliptical "Fine-Line" stylus is used on this cartridge. The shape of the stylus allows contact with the groove walls along thin edges in a manner similar to that of the special styli developed for CD-4 cartridges to give better high-frequency tracking and lower record wear. The compliance of the cartridge is rated 25 horizontally and 15 vertically, and the equivalent tip mass is 0.5 mg. The range

of tracking forces is rated at 1.5 to 2.0 grams, with 1.7 grams being the force recommended by Ortofon. The vertical tracking angle is 20°. Total cartridge mass is 7 grams.

The stylus drives the signal-generating coils through a cantilever whose diameter is stepped to provide stiffness with low mass. The fixed end of the cantilever is supported and damped by a rubber suspension, and the motion of the stylus "wiggles" the dual coil assembly in a powerful magnetic field. Each coil has only 28 turns of very fine wire. Hence, the output signal voltage at a 5-cm/s recorded velocity is a mere 70  $\mu$ V. The dc resistance of the coils is 2.5 ohms/channel, and the inductance is negligible.

The Model MCA-76 preamplifier used with the cartridge has a voltage gain of 50, which increases the minute output level of the cartridge to about 3.5 mV. The input impedance of the preamplifier is 75 ohms, which is a suitable load for the cartridge. The output impedance of

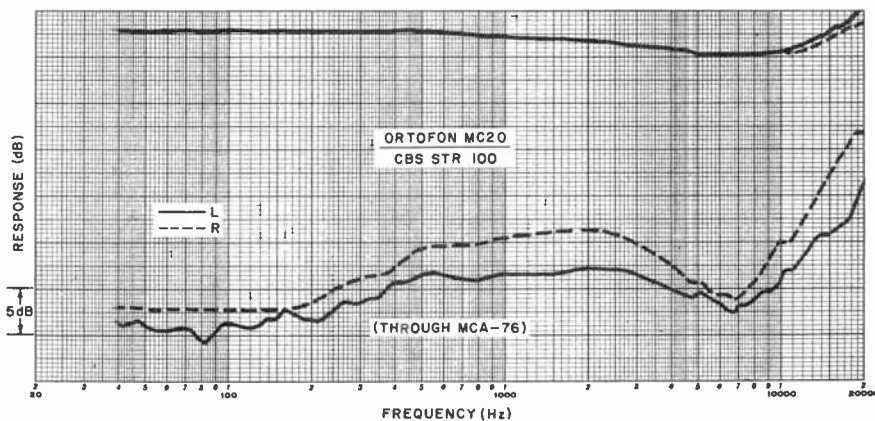

*Frequency response (top) and channel separation of both channels.*

less than 140 ohms allows the preamplifier to drive long cable lengths or to be terminated by almost any preamplifier input circuit without modifying the response of either the cartridge or the amplifier.

The maximum input rating of the preamplifier is 6 mV to provide a 300-mV output, providing the assurance that it will never limit the system's dynamic range. The preamplifier's distortion is negligible, rated at less than 0.04% THD and 0.01% IM at the maximum input levels. Hum is rated to be 120 dB below the maximum operating level. Since this is almost 40 dB above the nominal output of the cartridge, the net S/N ratio is on the order of 80 dB, which is highly noteworthy and surpasses the S/N of any preamplifier that is likely to be used with this cartridge preamplifier.

The preamplifier is housed in a small black box and has its own integral ac power supply. A pushbutton switch at one end of the box shuts off the power and simultaneously bypasses the amplifier circuits when in the out position. This allows the preamplifier to be left connected to a record player in which other types of cartridges will also be used. A second button on the case allows insertion of a built-in CD-4 low-pass filter to roll off the response sharply beyond 50,000 Hz. This prevents interference with the demodulator circuits

the frequency response of the cartridge sloped gently downward with increasing frequency, to about -2.5 dB between 5000 and 10,000 Hz, before rising to between +1 and +2.5 dB at 20,000 Hz. (The two channels responded slightly differently.) The rise was obviously the lower skirt of a relatively undamped stylus resonance, but we did not extend our measurements beyond 20,000 Hz.

Channel separation measured 20 to 25 dB up to 10,000 Hz and beyond. It decreased to 12 to 18 dB at 20,000 Hz. The square-wave response of the cartridge with the CBS STR112 test record revealed fairly low-level sustained ringing over the entire duration of the square wave at a frequency we estimate to be about 40,000 Hz. The measured vertical tracking angle was 20° (as rated).

The output of the cartridge at 3.54 cm/s was about 5.1 mV when using the Model MCA-76 preamplifier, with the two channels matched to within 0.4 dB. In our tracking tests, the cartridge was able to play all levels of the Shure TTR-110 record at 2 grams, although there was a hint of mistracking at the highest level of the bass drum. The 60-micron level of the German Hi-Fi Institute test record was barely tracked at 2 grams. Using the Shure TTR-103 record, the 10,800-Hz tone-burst distortion was low at less than 1% at all velocities up to 30 cm/s maximum.

quired just slightly greater than 8 mV at the input.

We could not measure the noise level of the preamplifier. It was below the minimum levels readable on our instruments.

**User Comment.** An extended listening experience with the cartridge/preamplifier system did nothing to resolve our doubts about whether or not moving-coil cartridges have special qualities. We never heard anything in the sound of this cartridge that we did not hear more or less when playing the same records with other good cartridges. Unfortunately, we were not able to make true A-B comparisons with this and other cartridges in identical tonearms playing the same record.

In the same vein, the measured performance of the Ortofon cartridge reveals that it is good to excellent in practically every respect. After "living" with the new Ortofon cartridge for an extended period, we eventually came to realize that its sound was impressively devoid of harshness and identifiable coloration, measurements aside. We got the personal sense that this cartridge has a clarity and definition that place it somewhat apart from other cartridges, although we would not be able to support this statement objectively.

To our hearing, the preamplifier contributes no noise when in operation. At the highest listening levels we could use, lifting the pickup resulted in dead silence from the speaker systems. (At higher gain settings, which we do not consider to be normal for listening, some slight amount of hiss could be heard.) We did find, however, that there was enough power-line hum pickup in the cartridge circuit, apparently from ground loops, to be audible at high gain settings when the cartridge was installed in the Thorens tonearm. The magnitude of the hum varied with our choice of amplifier and was much less when we installed the cartridge in other tonearms. It appears that this hum problem was a peculiarity of our installation and cannot be chargeable to the record player or cartridge.

This is one of the best as well as one of the most expensive phono cartridges we have used. (We include the cost of the cartridge preamplifier in our assessment; the cartridge alone is not unusually expensive.) In combination with a suitable audio system, it will provide as great a sense of reality as any other top-quality cartridge.

Square-wave response revealed low-level ringing.

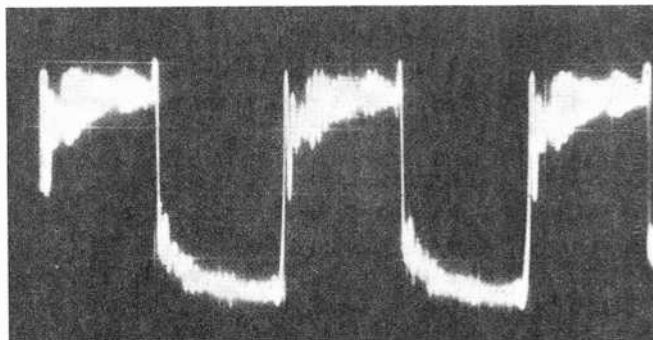

from r-f noise pickup. There is a fixed subsonic filter that cuts off the response very sharply below 7 Hz.

**Laboratory Measurements.** We tested the cartridge both directly at its outputs and through its companion preamplifier. For most of our tests, the cartridge was installed in the tonearm of a Thorens Model TD-126C player.

Experimenting with different tracking forces, we found that a 2-gram force was required to track the highest velocities on our test records. That force was subsequently used throughout our tests. Playing the CBS STR100 test record,

The IM test, using the Shure TTR-102 record, revealed that the distortion increased gradually from about 1.6% at velocities slower than 15 cm/s to 4% at 27.1 cm/s. There was no evidence of the severe mistracking that occurs with some cartridges at the higher levels of this record.

The Model MCA-76 preamplifier had a gain of 34 dB (equivalent to a voltage gain of 50)  $\pm$ 0.3 dB from below 10 Hz to well beyond 50,000 Hz. The 1000-Hz distortion was less than 0.04% for outputs up to 100 mV and only 0.1% at the maximum rated output of 300 mV. The output clipped at 430 mV, which re-



# Why you should buy a digital multimeter from the leader in digital multimeters.

If you're shopping for your first multimeter, or moving up to digital from analog, there are a few things you should know.

First, look at more than price. You'll find, for instance, that the new Fluke 8020A DMM offers features you won't find on other DMMs at any price. And it's only \$169.\*

Second, quality pays. Fluke is recognized as the leading maker of multimeters (among other things) with a 30-year heritage of quality, excellence and value that pays off for you in the 8020A.

Third, don't under-buy. You may think that a precision 3½-digit digital multimeter is too much instrument for you right now. But considering our rapidly changing technology, you're going to need digital yesterday.

**If you're just beginning, go digital.**

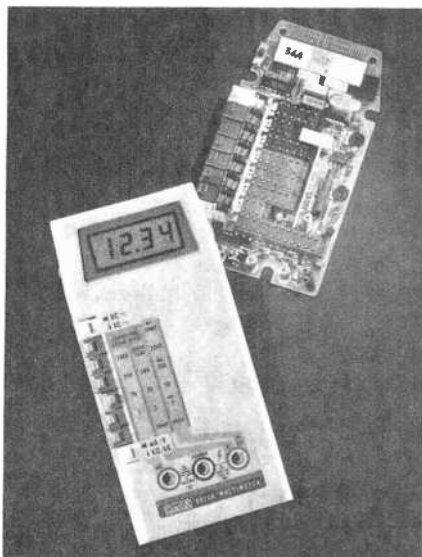

Why not analog? Because the 8020A has 0.25% dc accuracy, and that's ten

times better than most analog meters.

Also, the 8020A's digital performance means things like 26 ranges and seven functions. And the tougher your home projects get, the more you need the 8020A's full-range versatility and accuracy. The 8020A has it; analog meters don't.

**If you're a pro.**

You already know Fluke. And you probably own a benchtop-model multimeter.

Now consider the 8020A: smaller in size, but just as big in capability. Like 2000-count resolution and high-low power ohms. Autozero and autopolarity. And the 8020A is MOV-protected to 6000V against hidden transients, and has overload protection to 300V ac.

**Nanosiemens?**

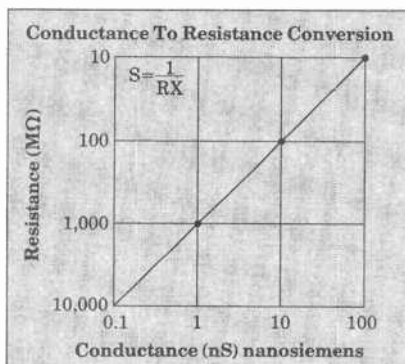

Beginner or pro, you'll find the meter you now have can't measure nanosiemens. So what? With the 8020A *conductance* function, you can measure the equivalent of 10,000 megohms in nanosiemens. Like capacitor, circuit board and insulation leakage. And, you can check transistor gain with a simple, homemade adapter. Only with the 8020A, a 13-oz. heavyweight that goes where you go, with confidence.

**What price to pay.**



\$169.\*

Of course, you can pay more. Or less. In fact, you could pay almost as much for equally compact but more simplistic meters, and get far less versatility. And, the 8020A gives you the 'plus' of custom CMOS LSI chip design, and a minimum number of parts (47 in all). All parts and service available at more than 100 Fluke service centers, worldwide. Guaranteed, for a full year.

Rugged. Reliable. Inexpensive to own and to operate; a simple 9V battery assures continuous use for up to 200 hours.

**Where to buy.**

Call (800) 426-3061 toll free. Give us your chargecard number and we'll ship one to you the same day. Or, we'll tell you the location of the closest Fluke office or distributor for a personal hands-on feel for the best DMM value going.

\*U.S. price only

**Fluke 8020A DMM for Home Electronics Experts: \$169**



# Memories are made of this.

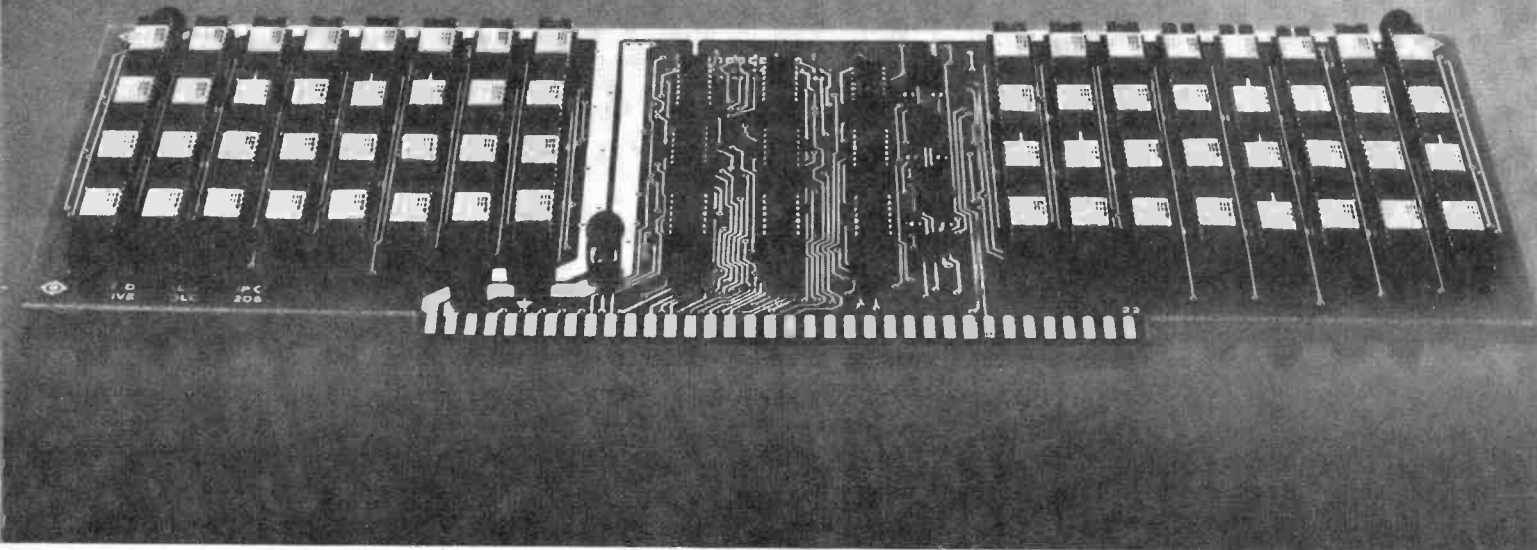

## 32K. One Card. One low price. Only from the Digital Group.

Now, on only one *fully static* card, the Digital Group has squeezed in a whopping 32K of memory. Which, with a little quick addition, means a full 64K architecture now requires only 2 boards instead of 8. That's a 4-to-1 space reduction ...and leaves one extra memory slot on the Digital Group's standard motherboard still available for future products.

All this and one low price, too.

It just may be the best news of all. Our full static, assembled and tested 32K memory board is only \$995. Now that's worth remembering. It's substantially less than our equivalent assembled 8K board prices. (Please note: We're initially offering this 32K board assembled only, but kit versions will soon be available, too—at even lower prices.)

Here's what you get.

### Specifications:

- 32K on single card
- Speed—450ns. All of our current CPUs will operate at full-rated speed.
- Decoding—Lower or upper 32K bank
- Power—+5V only @ 4A
- Card size—12" x 5" (excluding connector fingers)

### Features:

- May be intermixed on Digital Group systems with our 8K memory cards

- All data and address lines are buffered
- *Fully static* memories—EMM 4801 (450ns) or equivalent

### Price:

32K board complete, assembled and tested \$995.00

For all the memorable details, just fill out the coupon below. (Then all you have to remember is to mail it in.)

the digital group

P.O. Box 6528  
Denver, Colorado 80206 (303) 777-7133

I promise to mail this in, so add me to your mailing list!

Name \_\_\_\_\_

Address \_\_\_\_\_

City/State/Zip \_\_\_\_\_

Remember me? I'm already on your mailing list, but I need the memory spec sheet desperately.

**A**UTOMATIC percussion synthesizers are popular musical accompaniment accessories. The "Cabonga" described here is a percussion synthesizer that is designed to be played by hand like a conventional bongo drum. All electronic, it is battery powered and produces an output that can drive just about any instrument amplifier/speaker system.

The Cabonga electronically generates a damped sine wave whose frequency is continuously variable to provide sounds that range from a bass drum to a wood block. Its exponential decay time can be varied from a fraction of a second to more than two seconds to simulate sounds that range from a click to a timpani.

Provisions are included for both local and remote triggering. In addition, a multivibrator (such as the automatic trigger accessory to be described next month) can be used to continuously trigger the Cabonga at a preset rate. By interconnecting the external-trigger jacks of two or more Cabongas, you can simulate a wide range of percussion instruments at one time.

In this first part of a two-part article, we discuss the operation and construction of the basic Cabonga. Next month, we cover the accessories that can be used with it. These include snare-drum, automatic triggering, special-effects sound modifier, and a combination ac power supply and active audio mixer.

**About the Circuit.** The circuit of the Cabonga is shown schematically in Fig. 1. When the drum head is struck, *S1* closes and applies a positive-going pulse to *C1* and *R2*. This pulse is passed by *C2* and *D2* to the tone generator. When *S1* opens and *C1* discharges, the negative-going pulse produced is shunted to ground by *D1*.

The tone generator is a twin-T active filter made up of *IC1B*, *R4*, *R5*, *R10*, and *C3* through *C6*. An additional feedback loop is made up of *R8* and *R9*. With the component values shown, applying a trigger pulse produces an exponentially damped sine-wave output. Potentiometer *R10* determines the operating frequency of the sine wave, while *R8* and *R9* in the feedback loop determine the decay time of the damping. The output signal from the tone generator is attenuated by volume control *R11* and is buffered by *IC1A* and fed to *J3* for subsequent processing.

**Construction.** The Cabonga's circuit can be assembled on perforated board or a printed circuit board, the etching

# BUILD "cabonga"

## AN ELECTRONIC PERCUSSION SYNTHESIZER

BY JAMES BARBARELLO

*Played like a bongo drum, the Cabonga produces waveforms that simulate sounds of percussive instruments from bass drum to wood block.*



PART 1



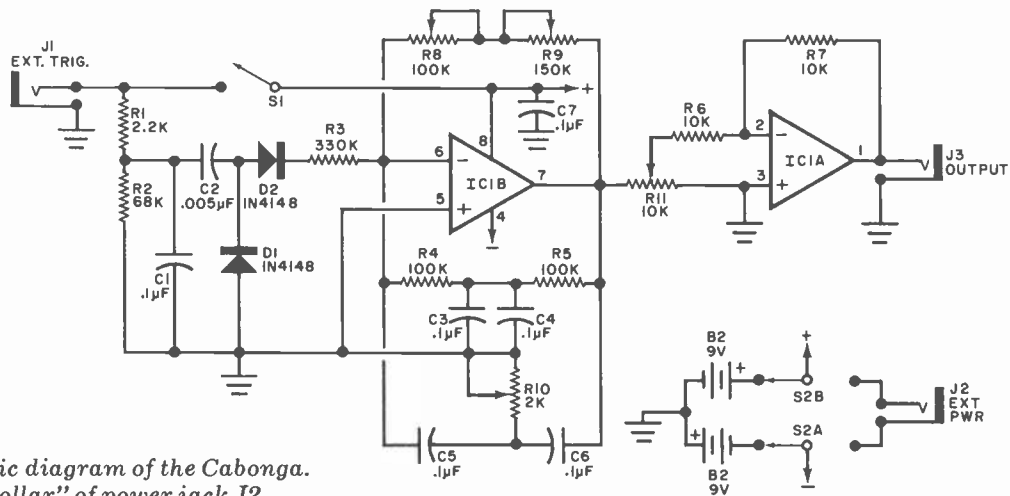

Fig. 1. Schematic diagram of the Cabonga. Note that the "collar" of power jack J2 is at -9 volts, not ground potential.

**PARTS LIST**

B1, B2—9-volt transistor batteries  
 C1, C3 through C7—0.1- $\mu$ F disc ceramic capacitor  
 C2—0.005- $\mu$ F disc ceramic capacitor  
 D1, D2—1N4148 silicon diode  
 IC1—5558 dual operational amplifier IC  
 J1—Subminiature phone jack  
 J2—Miniature phone jack (insulated)  
 J3—Standard phone jack  
 The following resistors are 1/4-watt,

10% tolerance, carbon composition:  
 R1—2200 ohms  
 R2—68,000 ohms  
 R3—330,000 ohms  
 R4, R5—100,000 ohms  
 R6, R7—10,000 ohms  
 R8—100,000-ohm, linear-taper pc trimmer potentiometer  
 R9—150,000-ohm, linear-taper potentiometer  
 R10—2,000-ohm, linear-taper potentiometer

R11—10,000-ohm, linear-taper potentiometer  
 S1—Oak feather-touch calculator keyboard NO switch (Poly Paks 92CU1749 or equivalent).  
 S2—Subminiature dpdt switch  
 Misc.—Printed circuit board; battery clips; hookup wire; hardware; solder; etc.  
 Note: See Bill of Materials (next page) for availability of kits.

and drilling and component-placement guides for which are shown in Fig. 2. In either case, it is recommended that you use a socket or two rows of Molex Soldercons for the IC. Also, be sure you observe the proper polarities and orientation of the components.

The circuit board, batteries and holder, jacks, etc. can be mounted in any convenient size box that will accommodate them and the momentary-action pushbutton switch used for triggering the Cabonga.

The box can be made from four pieces of 3/4" (19.1-mm) thick plywood for the sides and two pieces of 1/4" (6.4-mm) thick Masonite or tempered hardboard. The overall dimensions of the box should be roughly 9 1/2" x 7" x 2" (24 x 17.8 x 5.1 cm). The top and bottom of each wall should be rabbeted to provide 3/8" (9.5-mm) deep by 1/4" wide "shelves" so that the top and bottom plates are flush with the top and bottom of the walls. (Note: If you do not have a router to make the rabbets, you can make each

wall from separate pieces of 1/2" and 1/4" plywood, cutting the latter 1/2" narrower and fastening the pieces together with glue and 5/16" finishing nails.) Round all top and bottom edges of the walls with sandpaper.

The top plate must be finished to permit mounting of the controls, switches, jacks, and the drum head assembly, as shown in the lead photo. If you use a metal control plate as shown, be sure that jack J2 is isolated from it. The calculator switch used under the drum head as the trigger switch is not mounted on the top plate. Hence a 1 1/2" (3.8-cm) hole must be drilled for it. Fix the center of this hole at the mid-point of the shorter side and 3" (7.6-cm) up from the end opposite the location of the jacks and controls. Drill the hole where the two measurements coincide.

Next, referring to detail A in Fig. 3, fabricate the drum head switch retainer assembly from white pine lumber. Note the grooves in which the hardboard on which the switch is mounted fits. You do not need a router to make these grooves; a sharp wood chisel will do satisfactorily because of the softness of the pine. The No. 8 x 1" sheet metal screw used for adjusting the sensitivity of the drum head should have its point filed off.

Once the retainer assembly is fabricated, fasten it to the bottom surface of the top plate with glue and flathead wood screws. Coat the top surface of

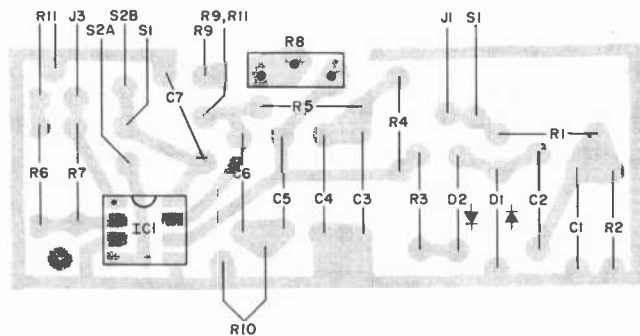
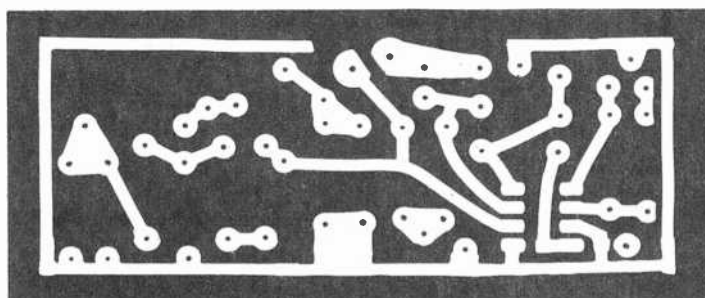
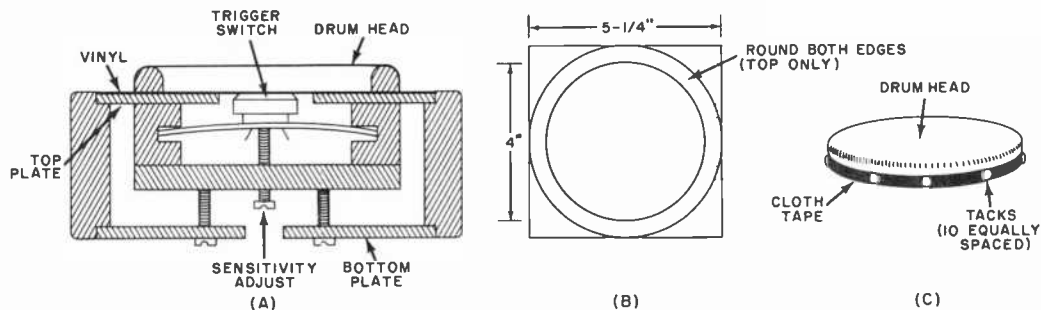

Fig. 2. Etching and drilling guide (below) and component layout (left) for the Cabonga pc board.



**Fig. 3. Details for construction of switch retainer assembly (A), plywood head ring (B). Finished drum head is shown at (C).**



the top plate with contact cement except for a 5 1/2" diameter circular area centered at the keyswitch hole. Neatly cover the plate with black vinyl, overlapping it on all sides. Cut away the vinyl from around the holes already drilled but *not* from around the keyswitch hole.

The collar over which the drum's diaphragm is stretched is made from a 6" square by 3/4" thick (15.2 x 15.2 x 2 cm) piece of plywood. When the wood ring has been cut out, round the top outer

mastic surfaces must close up on each other. This tape is the decorative band that goes around the drum head and covers the staples holding the diaphragm. To hold it in place, use 10 chrome-finished upholstery tacks around the circumference of the ring collar. (See details B and C in Fig. 3.)

Use four 3/4" flathead wood screws to fasten the drum head assembly to the top plate, centering it over the calculator key trigger switch. Then glue a block of

described above for locating the center of the calculator key hole, locate the center of the access hole for the sensitivity-adjust screw on the key switch retainer assembly. Drill a 5/16" (8-mm) hole at this point. Strike a line passing through the center of this hole and parallel to the bottom edge of the plate. At points approximately 1" (2.54 cm) on both sides of the access hole, drill a 1/8" (3.2-mm) hole.

Smoothly sand and clean the bottom plate. Then coat a sheet of black vinyl with contact cement and neatly attach it to the outer surface of the bottom plate. Again, overlap the vinyl around all edges and onto the inner surface. (If you wish, you can fasten a sheet of ribbed rubber

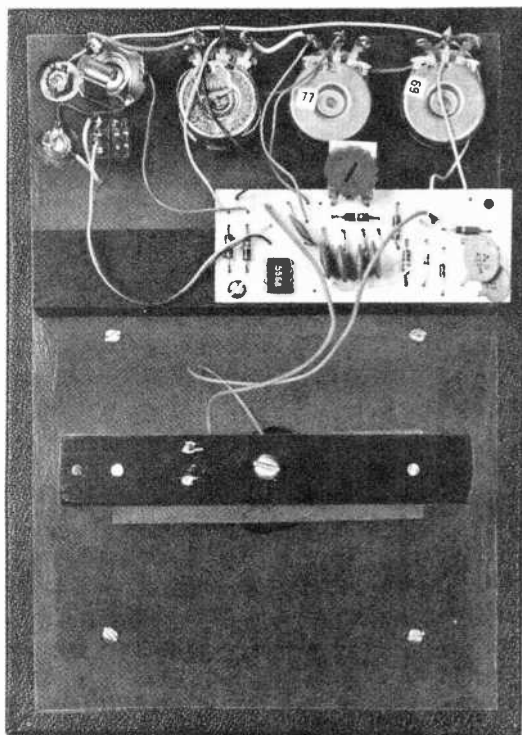

**Fig. 4. Bottom view of the finished top plate shows the locations of the switch retainer assembly, pc board, controls and jacks.**

and inner edges so that the top forms almost a semicircle. Smoothly sand all surfaces. Then stretch a single layer of fabric-backed white vinyl over the top of the ring collar, fastening it in place with wire staples. Allow the vinyl to overlap the bottom edge and staple it to the side of the ring. Cut the vinyl flush with the bottom edge of the ring. Now, fold an 18" (46-cm) length of black Mystic cloth tape along its entire length 1/8" in from both edges so that the tape has a seam down its center. When you fold the tape, the

3/4" square by 5 1/4" long pine to the top plate as shown in Fig. 4 to provide a means for mounting the circuit board assembly and batteries. When the glue has set, fasten the battery holder and the circuit board assembly side by side on the top of the block with woodscrews. Interconnect the board with the various controls, switches, and jacks with insulated hookup wire. Temporarily set aside the top plate assembly.

The bottom plate can be prepared as follows. First, using the same procedure

#### BILL OF MATERIALS

##### Case

- 2—pieces 3/4" plywood 9 1/2" x 2"
- 2—pieces 3/4" plywood 6" x 2"
- 1—piece unsupported black vinyl 35" x 4 1/2"

##### Top Plate

- 1—piece 1/4" tempered hardboard (Masonite or equivalent) 8-3/8" x 5-7/8"
- 1—piece black vinyl 9 1/4" x 6-3/4"

##### Bottom Plate

- 1—piece 1/4" tempered hardboard 8-3/8" x 5-7/8"
- 1—piece rubber matting 8-3/8" x 5-7/8" or 1 piece black vinyl 9 1/4" x 6 3/4" (see text)

##### Head

- 1—piece 3/4" plywood 6" x 6"
- 1—piece cloth-backed white vinyl 7 1/2" x 7 1/2"
- 1—piece black cloth tape 18" x 3/4"
- 10—chrome upholstery tacks

##### Control Plate

- 1—piece 1/32" aluminum stock 5-7/8" x 2"

##### Switch Assembly

- 1—piece 3/8" pine 4 1/2" x 3/4"
- 2—pieces 5/8" pine 1" x
- 1—piece 1/8" hardboard 3 1/2" x 1"

##### Miscellaneous

- 1—5" x 3/4" x 3/4" pine block
- 4—No. 8 x 3/4" wood screws
- 1—No. 8 x 1 1/4" sheet metal screw
- 2—No. 8 x 1" sheet metal screws
- Nails, glue, etc.

Note: The following are available from JAL Associates, Box 107, Eatontown, NJ 07724: Complete kit including all components (M1), \$32.50; parts kit (M1-E) including all electronic components, jacks switches, pc board, \$19.50; etched and drilled pc board (M1-PC), \$3.50. All prices include postage. New Jersey residents add 5% sales tax.

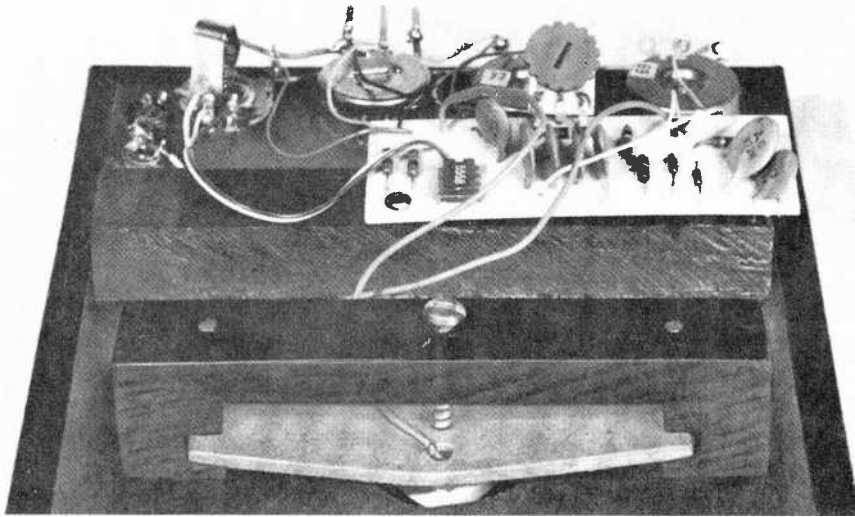

Side view of top plate reveals mounting details of switch retainer assembly, tension adjust screw and pc board.

runner to the outer surface of the bottom plate with contact cement instead of the vinyl. The runner will provide an antiskid grip when the Cabonga is placed on a table as it is being played.) Clear away the vinyl (or rubber runner) from around the three holes. If you are using the rubber runner, clear away enough of it to allow the two screws that go into the holes on both sides of the access hole to go far enough in so that their heads sit flat against the bottom plate. Temporarily set aside the bottom plate assembly.

Smoothly sand and clean all exterior surfaces of the box wall assembly and then coat all surfaces with flat black paint. When the paint has dried, coat the rear surface of a 35" x 4½" (90 x 11.4 cm) sheet of black vinyl with contact cement and wrap it around the wall assembly. Start about 1" from one corner and finish up at the same corner; trim off any excess vinyl to make a neat seam. At each corner, slit the vinyl and trim it as necessary. Carefully fold the vinyl over the top and bottom edges and into the rabbets. Try to avoid having any of the wood show through as you trim.

Before final assembly, check that the air seal between the drum head and the vinyl covering the key switch on the top plate is sufficient for proper triggering. To do this, first adjust the sensitivity screw on the key switch retainer assembly so that it is slightly depressed by the vinyl on the top plate. Press down on the drum head and note whether or not the key switch moves. If it does, the seal is sufficient; if not, you will have to tighten the screws that secure the drum head to the top plate until you get sufficient air sealing. If all else fails, you might have to remove the drum head assembly and

place gasketing material between it and the top plate.

Final assembly consists of placing the top and bottom plate assemblies in the box wall assembly and securing the whole unit together with two No. 8 x 1¼" sheet metal screws passed through the bottom plate's holes and driven into the crossbar on the switch retainer assembly.

**Checkout.** To check out the operation of the Cabonga, it is necessary to take it out of its case. Once this is done, feed the output of the Cabonga from J3 to an instrument amplifier. Turn on the power via S2. Now, set PITCH control R10 to about its 9 o'clock position and DECAY control R9 and VOLUME control R11 fully clockwise. Then turn the sensitivity-adjust screw for the key switch until the switch closes and you hear a sound. Back off on the adjusting screw until the sound drops out and you can hear it only when the drum head is struck.

If the Cabonga breaks into oscillation, adjust trimmer potentiometer R8 until the oscillations just cease. If you hear no

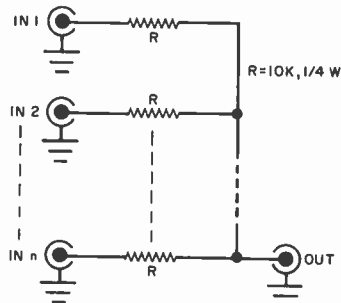
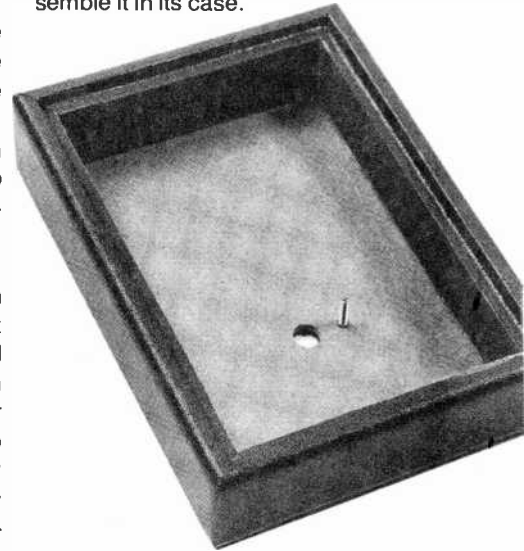

Fig. 5. Mixer combines several signals for use with one amplifier.

oscillations on initial checkout, adjust R8 until you do and then back off until the oscillations just drop out. Replace R4 with a 68,000-ohm resistor if you cannot obtain oscillations no matter where R8 is set.

After the initial adjustment is made, vary the PITCH control over its entire range to determine whether or not oscillations still occur. The circuit might continue to oscillate at higher frequencies, such as at the fully clockwise position of the PITCH control. If these oscillations do occur at high frequencies, break the connection between R10 and the C5/C6 network and insert a 10-ohm resistor between the potentiometer and capacitors.

Experiment with the settings of the PITCH, DECAY, and VOLUME controls while striking the drum head to determine whether or not the project is operating properly. When you are satisfied with the operation of the Cabonga, reassemble it in its case.



Bottom with rabbeting, tension adjust hole and retaining screw.

**Use Ideas.** You will probably want to use several Cabongas, each tuned to produce a different sound, at the same time to simulate different musical effects. To interconnect all Cabongas you might wish to use, you can do so with the passive summer shown in Fig. 5. Some attenuation of the signal will occur when the summer is used, but the output level will still be adequate to drive most instrument amplifiers.

When interconnecting Cabongas via the external trigger jacks, you must adjust the individual volume controls so that all sounds can easily be heard.

Next month's discussion of a number of accessories will enable you to add to the Cabonga's versatility. Until then, you have an instrument that should provide many hours of entertainment. ◇



# CHOOSING PORTABLE & MOBILE TAPE RECORDERS

BY JAMES R. HORSTMAN

*Tape enthusiasts need not  
be tied to a wall socket.*

**T**HE CASSETTE and 8-track cartridge tape formats for portable and mobile applications have grown and prospered side by side, each boasting its own unique advantages.

The standard compact cassette is actually a small, reel-to-reel tape housed in a self-contained plastic shell that measures only 4" long by 2 1/2" high by 7/16" thick. Like open-reel tapes, with separate supply and feed reels, it may be re-wound or turned over to play other tracks. When the loaded cassette machine is activated, a small pinch roller moves the tape smoothly at 1 1/2 ips. Tape measures about 1/8" wide and is available in 20-minute to 120-minute play- or record-time formats.

Now, there are also sub-compact cassettes. They're designed primarily for voice-dictation and note-taking purposes. Moreover, there are at least four sub-compact systems that are not interchangeable.

The tape cartridge, on the other hand,

is much different. Its tape is wound in a continuous loop that's fed from the center of a single reel and rewound on the outside of that same reel, permitting continuous play. When it reaches the end of one revolution, the playback head moves over a notch (manually or automatically) to play the next track. In stereo, this head-moving process occurs four times, while in 4-channel it's done twice. Compared to a cassette, a cartridge is bulky, being four times its size. Tape speed is 3 3/4 ips and tape width is 1/4", which, theoretically should make the cartridge superior to the cassette in terms of potential hi-fi reproduction. Further, each tape cartridge contains its own pinch roller (which most experts feel is *not* an advantage).

Theory aside, however, the standard cassette system generally provides better fidelity. This is due, in part, to the special tape formulations available for cassettes. Additionally, the 8-track cartridge drive and head alignment systems

are inherently less precise than a cassette's. But these differences are less noticeable in portables and auto units since Dolby noise-reduction circuitry, dual capstans, etc. are rarely used.

As a result, choice of format generally involves considerations other than high-fidelity sound. For example, if one were to choose a battery-powered portable, it's likely that the choice would be a cassette. Due to its much smaller size and lighter weight, it has essentially eliminated cartridges from this market. Further, cassettes can be rewound and have a fast-forward speed, making it much easier (and faster) to locate specific recorded sections on the tape. Also, most 8-track machines do not offer record facilities, while most cartridge machines do.

Selecting a car tape format, however, is an entirely different story. Here, 8-track cartridges got the jump on cassettes when Lear Jet teamed up with RCA and Ford before Phillips got up

steam with its cassette format.

Aside from the auto tape lead initially enjoyed by 8-track, the no-fumble convenience of simply pushing a cartridge into a slot while driving and listening to commercial-free music played without ending attracted many people. It still does, thanks to the availability of a large library of prerecorded tapes and the easy transition from stereo to 4-channel sound made possible by the 8-track cartridge system. The latter is something cassette manufacturers are still struggling with.

Cassettes are challenging the 8-track machine in automobiles, though. Compact size is one reason. Another is the ability to locate portions of a recording very quickly. And, equally important, if a person owns a home cassette deck, the recording facility and interchangeability permit a cassette to do double duty. Also, there are automatic-reversing cassette systems now available for continuous listening.

**Shopping for Portables.** The way to start shopping for tape portables is to sit down with paper and pencil and assess the quantity and quality of portability you will require. Very often, these two go together, as extra dollars add desirable features you'll find you cannot do without. Once you have seen some deluxe unit, it's difficult to go back "down."

Chances are that you'll choose a battery-powered cassette unit, since there aren't many cartridge machines around. Most portable cassette machines are monophonic, which is just as well since you wouldn't want to pack an extra speaker wherever you go. However, if you're willing to sacrifice small size and light weight, there are a handful of ac-dc portable cassette machines that record and play back in mono or stereo. Some do feature two built-in speakers and two microphones for stereo use. (Sub-compact cassettes exhibit poor fidelity for reproducing music as compared to the conventional cassettes.)

Costlier cassette models offer a host of extra features you might want to check out. Here are some examples:

- Ac and dc operation to extend battery life.
- Built-in battery charger for automatic charging when plugged into an ac outlet.
- Larger speaker(s) for more robust sound.
- Automatic shutoff with mechanism disengage when tape play is ended.
- Automatic level control to maintain relatively constant sound recording level, so that the recordist need not continually monitor a volume control.
- Large VU/battery indicator for easy viewing.
- Tone control to adjust playback to your liking.
- Tape counter to permit quick location of a recorded portion of your tape.
- Tape select switch to give you the flexibility of using premium tapes.
- Speedier fast-forward and rewind time for impatient users.

*These tape recorders illustrate the types available to "on-the-move" tape enthusiasts. Clockwise from upper left: an in-dash AM/stereo FM multiplex radio with cassette player; portable AM/FM radio cassette recorder with weather band; cassette deck for a car with under-dash mounting bracket; portable stereo cassette deck with ANRS and other features.*

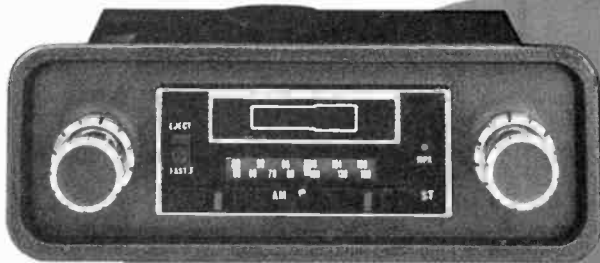

J.I.L. Model 604



General Electric Model 3-5212



JVC Model KD-2



Nakamichi Model 250

- Dual flywheels for reduced wow and flutter.
- Servo-control motor to maintain accurate speed when batteries weaken.
- Interlocking pause control for stable recording speed when starting and stopping.
- Remote microphone provisions to free you from the machine.
- Variable pitch control for the critical music lover.
- Peak limiter to automatically prevent distortion from overloading.
- Subminiature size for handy carrying.
- Stereo provisions.
- More powerful amplifier(s).
- Automatic voice activator so you don't miss a thing.

Clearly, there will have to be tradeoffs. Each "extra" chosen adds to the cost, weight, and/or size. The latter is sometimes offset by superb miniaturization with rugged construction, but the trade-off here is higher cost.

How does one "test" a portable? There are a number of guidelines. • First, handle it to judge weight and size. • Play cassette tapes that you've heard on a high-quality cassette deck (preferably a tape with plenty of highs and lows, and one with a solo piano recording). • Record a tape for playback at home. • Record a few minutes on a C-120 (two-hour) tape, which is ultra thin, to judge tape-handling quality. • Jingle keys so you can determine recording and playback realism. • Speak at the same level at different distances and with your back turned to evaluate how much the voice is obscured by the machine's noise. (You'll be surprised at the substantial differences among machines.) • Try the pushbuttons to be sure they're conveniently located and don't stick. • Attach an external, high-efficiency speaker system to the portable's external speaker jack.

Above all, don't lose sight of your quest for *portability*. After all, you don't want to be a furniture mover every time you wish to take along your portable.

### Shopping for Auto Tape Players.

A major reason for the popularity of the automobile tape player is that even a relatively inexpensive system sounds better in the car than at home. The closed environment and masking of fidelity limitations by external noise (engine, wind, tires, etc.) makes listening a rewarding experience. The choice of music is yours, not the disc jockey's nor the broadcast station's commercials. Equally important, there isn't much to distract you in the car.

You'll have to make a choice between 8-track cartridge and cassette machines. As discussed earlier, 8-track offers many more prerecorded selections, largely nonclassical. The cartridges are bulkier, though, and it's difficult to locate portions of a recording with dispatch. However, they play continuously, so a cartridge doesn't stop when the recording ends, but continues 'round and 'round. When driving; this no-handling facility is advantageous. Consider, too, that 8-track offers 4-channel sound, which provides a unique sound sensation, especially in an auto environment.

The favorable attributes of cassette machines can be recapitulated as: smaller machine, which makes for easier car installation; smaller tape package so you can store more cassettes in a small space; fast-forward and rewind facility; and a convenient recording facility (at home). So take your choice.

**Cassette Players.** Cassette car players are small enough to be mounted in the dashboard where the car radio goes or in the glove compartment—both major deterrents to theft—although many are still mounted under the dash. Whichever position you choose, practice loading the unit a few times before you try it on the road. With a glove-compartment mount, of course, you'll have to pull over to the side of the road to change tapes.

If you have a cassette deck at home, you can get more from your mobile unit by making your own recordings. You can save money, too, since prerecorded tapes are costlier than discs by one or two dollars. Furthermore, with a high-quality cassette deck and good source equipment and material, you can make better tapes than you can buy. (Exceptions, here, are the premium prerecorded cassettes made on chromium-dioxide tapes by Advent of classical music.)

An increasingly popular option in car cassette units is a built-in stereo FM radio, which gives the driver more program options. Many of these models have a clever "custom" look in which the radio tuning dial also serves as the cassette slot. Some are wired to record directly off the air (usually in mono, although the unit will play back in stereo), while others even have a hand-held microphone so you can dictate while you drive. If you have only an AM radio in the car, as many of us do, this combination can be most rewarding.

Other features to look for in an auto cassette machine (remembering that they add to the cost) are: automatic reverse, multiband radio, automatic stop

and/or reject, and signal-seeking on the radio.

**8-Track Players.** Features you may want to consider in 8-track machines are track indicators, bass boost, and automatic track switching. Models with automatic play-through often feature a manual override switch so you can select channels if you wish. Cartridge players, too, have been mated with AM/stereo FM radios.

**Speaker Installation.** Installing speakers and positioning them properly generally presents a severe challenge to the do-it-yourselfer. Probably most people should turn the job over to a specialist, such as an auto dealer or auto radio/tape player installation outfit.

A popular speaker-mounting location is in the front door. There are also kick-panel installations in case the thought of cutting into doors upsets you. The latter technique is less expensive too. Underdash installation of speakers is another possibility, but the overall stereo or quadraphonic effect is reduced considerably. As for rear speakers, you have a choice of rear doors, trunk ledge, or external speakers. You'll have to find the combination that pleases you, based on the interior configuration of your car.

**Conclusion.** Before finalizing your buying decision—whether a portable or mobile tape machine in the cassette or 8-track format—listen to a unit a "price point" higher and lower to determine if you can hear the difference. Consider, too, whether or not your choice is a well-known brand, the reputation of the dealer, and what you have to do to obtain in-warranty and out-of-warranty repair. The latter is especially important with auto players since there is a removal-installation chore involved.

Don't expect to match the high-quality sound of your home hi-fi system in portables or mobile equipment—they rarely exceed 10,000 Hz response and are often well under that. If you want truly good sound, do consider adding a "booster" amplifier to increase output power so that some of the fine, compact, low-efficiency speaker systems can be satisfactorily driven. There are also some high-power audio systems designed for car use (including ADS, sold as a package with Nakamichi's 250 cassette player or 350 record/player.) In any case, experienced travelers feel that fairly good mobile sound is every bit as rewarding as great sound that just sits there. ◇





# NEW BAND FOR "KIDDIE-TALKIES"

*100-mW portable two-way radios are moving out of the CB band.*

BY LEO SANDS

**T**HE DAY of the 27-MHz band unlicensed walkie-talkie is coming to an end. Production of such units has been halted, but the millions of unsold walkie-talkies can still be sold until March 1978. After this time, unsold units must be junked or rebuilt for the new 49.9-MHz band to which personal-communication walkie-talkie operation has been moved. Existing 27-MHz band w-t's can still be used until March 1983.

The FCC established the 49.9-MHz personal-communication band for two good reasons. The first is that users of the 100-mW walkie-talkies operating on the 27-MHz Citizens Band are being clobbered by the standard 4-watt CB

transceivers that must be operated with a license from the FCC. The other reason is that CB'ers are being interfered with by the unregulated users of w-t's on the CB channels.

**Technical Details.** Under Part 15 of the FCC Rules and Regulations, no license is required to operate low-power (up to 100 mW) communication devices in the 26.97-to-27.27-MHz band and the 49.82-to-49.90-MHz band if the equipment meets applicable technical standards.

The power of the 27-MHz w-t's is limited to 100 mW input to the final r-f stage of the transmitter. The w-t's can be oper-

ated on any frequency within the band ranging from 26.97 to 27.27 MHz. This does not necessarily mean that operation must be on an exact frequency assigned to the normal CB channels.

The input power of the 49.9-MHz band w-t's is not specified, but radiation is limited to 10,000  $\mu\text{V}/\text{meter}$ , measured at a distance of 3 meters. These w-t's must be operated only on any of five channels whose specified frequencies are: 49.830, 49.845, 49.860, 49.875, and 49.890 MHz. The frequency tolerance must be within  $\pm 0.01\%$  of the channel carrier frequency. Either amplitude modulation (AM) or frequency modulation (FM) can be used as long as the

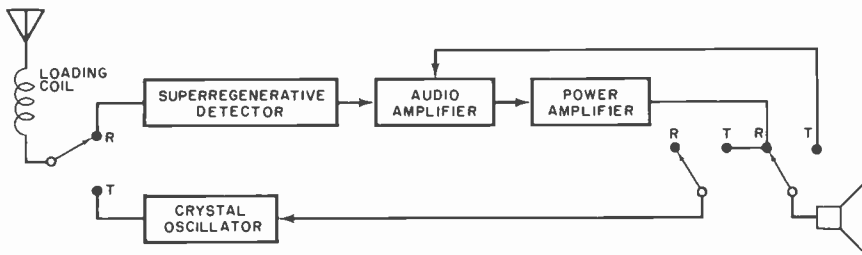

Fig. 1. This simple walkie-talkie uses a superregenerative detector.

emission is confined within a 20,000-Hz band centered at the carrier frequency.

The rules require that the microphone be built into the case of the w-t's and that the antenna be permanently attached to the box containing the transmitter. Factory-built w-t's must also be certified by the manufacturer and FCC as being in compliance with the applicable technical standards.

W-t's already in production use either a superregenerative or a superheterodyne design in the receiver section. All have crystal-controlled transmitters to assure on-frequency operation.

**Home Design Rules.** You can design your own w-t and build up to five 49.9-MHz band transmitters and/or transceivers for your own use. Here are some of the rules you must follow:

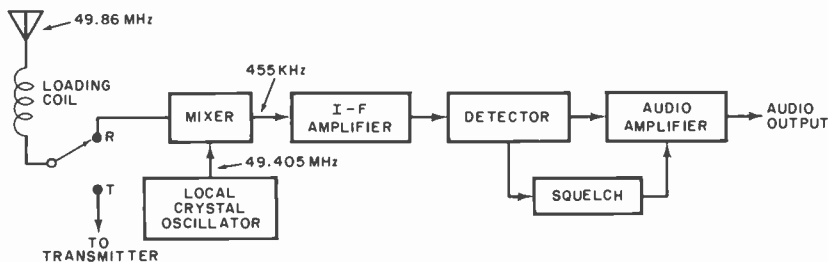

Fig. 2. Block diagram of superheterodyne receiver.

The antenna must be a single element that is not more than 1 meter in length. It must be permanently mounted on the case that houses the transmitter/transceiver circuitry. You can operate a home-made low-power communication device on any of the five 49.9-MHz band channels set aside by the FCC or on any frequency between these channels, provided the carrier and modulation products are contained within the 49.82-to-49.90-MHz range.

The total input power of the transmitter/transceiver, the latter in the transmit mode, must not exceed 100 mW under any modulation condition. Input power is measured at the battery or at the power line terminals if the w-t is ac operated. This means that if a 9-volt battery is the power source, total input current of all transmitter stages may not exceed 11.11 mA. If the power source is the ac

line, the total current drawn must not exceed 860  $\mu$ A.

The rules applicable to home-built 49.9-MHz band w-t's require that the microphone be an integral part of the unit. The rules also require that harmonic emissions must be at least 20 dB below the level of the unmodulated carrier. (These harmonics are at exact multiples of the carrier frequency—100 MHz, 150 MHz, 200 MHz, etc.) The 100-MHz second harmonic could interfere with FM broadcast band reception, while the 200-MHz fourth harmonic could cause TVI (television interference) to TV channel 11 and/or channel 12. The other harmonics could cause interference to nearby radio communication stations. Needless to say, it is extremely important to maintain harmonic radiation at the absolute minimum possible.

Although the rules for home-built devices do not state that the transmitter must be crystal controlled, it should be. Since the band is only 80,000 Hz (80 kHz) wide, a self-excited oscillator could drift enough to put the signal (even one of the sidebands) beyond the band limits into the 30-to-50-MHz land mobile band or the 50-to-54-MHz (6-meter) amateur radio band. By using a crystal, you can be fairly certain that its frequency is close to the frequency indicated on the case. If you do not use a crystal, you will need a frequency counter.

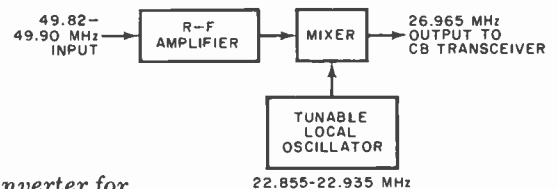

Fig. 4. Tunable converter for use with a CB transceiver.

**Some Design Ideas.** The simplest transceiver you can design would employ a superregenerative detector, crystal-controlled oscillator, and an audio amplifier that doubles as the modulator when transmitting, as illustrated by the block diagram in Fig. 1. A more elaborate transceiver would employ a superheterodyne receiver, as shown in the block diagram of Fig. 2. Alternatively, you could design a five-channel w-t with a crystal for each of the five channels and a switch.

For optimum radiation, the antenna should be a quarter wavelength long, or 1.5 meters (4.93') long, when an adequate ground plane is provided. Since antenna length is limited to 1 meter (3.28'), a loading coil in series with the output of the transmitter and input of the

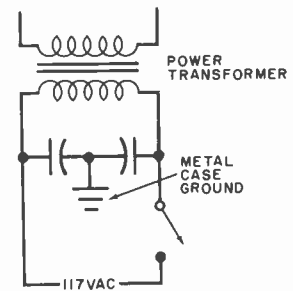

Fig. 3. Base station grounding.

antenna is required. In the case of a hand-held transceiver, the ground plane is inadequate for good antenna system efficiency. If you build the transceiver into a metal case, your body will effectively serve as the ground plane when you hold the w-t in your hand. If you build a base station, you can use a metal enclosure and ground it to the power line through a pair of capacitors, as shown in Fig. 3.

When you build your own 49.9-MHz band low-power communication device, it is a good idea to have the transmitter checked out by a professional unless you have the instruments and know-how to do it yourself. No matter who checks out the device, the following should be on the list: transmitting frequency; modulation level; occupied bandwidth; harmonic radiation; and input power. Occupied bandwidth and harmonic radiation can most easily be checked with a spectrum analyzer.

**Operating Hints.** Factory-made w-t's are usually equipped for single-channel operation on 49.860 MHz so that various users will be able to communicate with each other, regardless of which manufacturer made the transceivers. Since a lot of users can be expected to be operating on this channel, those who want more privacy and less interference will probably prefer another channel.

A hand-held w-t uses the same whip antenna for transmitting and receiving.



Six transistor "walkie talkie" from Interworld Enterprises.

When operating at a fixed location, receiving range can be increased by using a separate receiver connected to an external antenna. When communicating with a base station using such a receiving setup, your flea-power transmitter will be more effective.

The receiver can be one designed for hams and tunable through the 6-meter band (you might have to trim it to tune down to 49.82 MHz). You can also use a 6-meter converter with a standard short-wave receiver or a home-built converter with a CB transceiver (see Fig. 4).

If you use a separate receiver with an external antenna, you can improve the receiving range by increasing the height of the antenna. If the effective radiated power is +13 dBm (20 mW) and the signal delivered to an antenna 10' (about 3 m) above ground is -107 dBm (1  $\mu$ V), raising the antenna to a height of 30' (9 m) will increase the received signal level 10 dB to -97 dBm, or about 3  $\mu$ V.

When communicating with hand-held w-t's, the antennas of all units should be vertical or at the same angle. Otherwise, there will be a significant transmission loss due to conflicting polarization of the antennas involved.  $\diamond$

# SHUT-OFF TIMER For Battery-Powered Appliances

BY JEFFREY SANDLER

**I**T IS easy to attach a timer to a line-powered radio so that the power will be shut off after a certain time, should the listener fall asleep. It is not so easy with a battery-powered radio unless you build the simple circuit described here. With this simple add-on, you can fall asleep on the beach or in a hammock, secure in the knowledge that the radio will automatically shut down later to conserve the battery.

**Circuit Operation.** A schematic of the circuit is shown in Fig. 1. Resistor  $R1$  and capacitor  $C1$  provide a very long time constant. When  $S1$  is closed,  $C1$  is discharged and its low voltage is applied to the parallel high-impedance inputs of  $IC1$ . In this case the outputs of the NAND gates are high and the battery voltage is available at output 1.

When  $S1$  is opened, capacitor  $C1$  starts to charge slowly through  $R1$ . When the voltage across  $C1$  reaches about half that of the battery, the outputs of the NAND gates drop essentially to zero, effectively turning off output 1.

Transistor  $Q1$  is added to handle higher current loads. When output 1 is high,  $Q1$  is on and it supplies a higher current to output 2. The amount of current depends on the transistor used. Changing  $R1$  and  $C1$  changes the timing.

**Construction.** The circuit can be assembled on a small perforated board or a small pc board such as that shown in Fig. 2. You can make the board small enough to fit inside many transistor radios. The radio battery also supplies power to the timing circuit. However, the circuit draws so little current that it will not run the battery down when the radio is not in use. This low current demand is due to the use of CMOS logic and the high value of  $R1$ . Note that  $C1$  should have a very low leakage to maintain the charging interval.

The construction of  $S1$  is left up to the user. It can be a subminiature pushbutton switch, a pair of small bare leads that can be bridged with a fingertip or even a small mercury switch. If using the latter, simply momentarily tilt the radio on its side to "toggle" the timing circuit. If you elect to use your fingertip, you can vary the playing time by the length of time you keep your finger on the two leads. One to five seconds of contact time is usually enough to produce between five and 35 minutes of playing time.

The shut-down timer can be used to control almost any appliance if a separate battery is used for the timer and with output 2 driving a relay. The relay can then apply power through its own contacts to the appliance.  $\diamond$

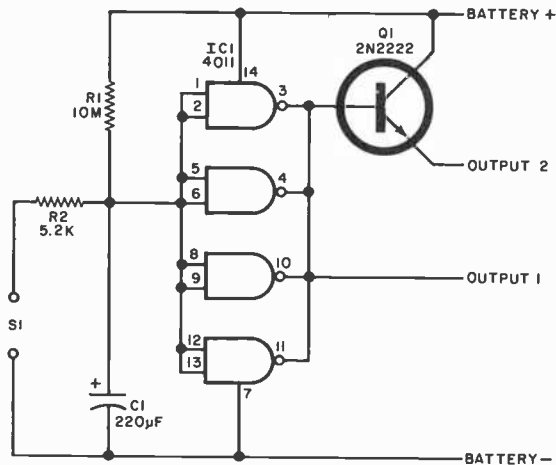

Fig. 1. Four parallel gates supply added power.

### PARTS LIST

- C1—220- $\mu$ F low-leakage capacitor
- IC1—4011 quad NAND gate (CMOS)
- Q1—2N2222 or any low-leakage npn silicon transistor
- R1—10-megohm,  $\frac{1}{8}$ - or  $\frac{1}{4}$ -watt resistor
- R2—5200-ohm,  $\frac{1}{8}$ - or  $\frac{1}{4}$ -watt resistor
- S1—See text

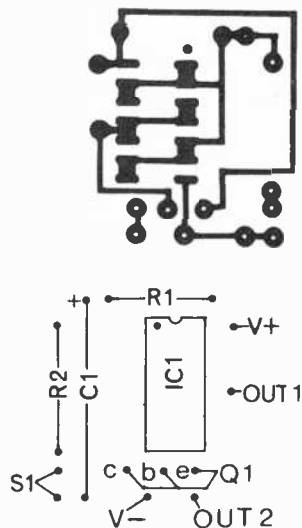
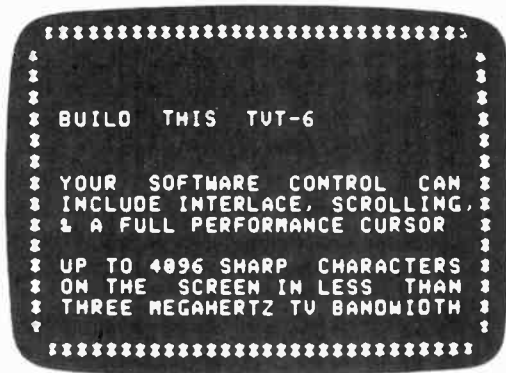

Fig. 2. Small pc board and component layout are shown.





# BUILD THE TVT-6 Part II

*System debugging, software, and how to interface to other processors.*

BY DON LANCASTER

**L**AST MONTH, we discussed construction of the TVT-6 TV typewriter and explained how it works and how it is connected to a KIM-1 microcomputer. We also started a discussion of the operating secrets of the TVT-6. Here, we complete the "secrets" discussion and go on to system debugging, some useful programs, and tell you how to interface the TVT-6 with other microprocessors.

**Software.** Four examples of tested, annotated, and workable KIM-1 software are given in the tables in this article. Table II contains a 16 x 32 scan program with full interlace. It automati-

cally generates almost all the timing required by the TVT-6 and its companion TV monitor for this display format. The program is run by jumping to memory location 17Ad. The display is stopped by interrupting with the operating system, the cursor, or other program.

Table III is an optional full-performance cursor for the 16 x 32 system and includes scrolling, full cursor motion, and erase-to-end-of-screen capabilities. It is run by allowing the key-press signal from the keyboard to interrupt the scan program (any of the three Tables) via the  $\overline{IRQ}$  interrupt line. Note that the cursor program is totally inde-

pendent of the SCAN program. The only things the two programs share in common are the same pages of display memory. The screen-read-to-cassette can be performed using the existing KIM-1 operating system programs. You can also load from cassette to display, using the automatic search firmware.

Table IV is a 16-line/64-character scan program that requires only 64 words to be written into memory for the entire program. This program can be used to display the entire 1k of minimum KIM-1 memory for use as a super front-panel display if desired. For display-only applications, 1k of contiguous memory

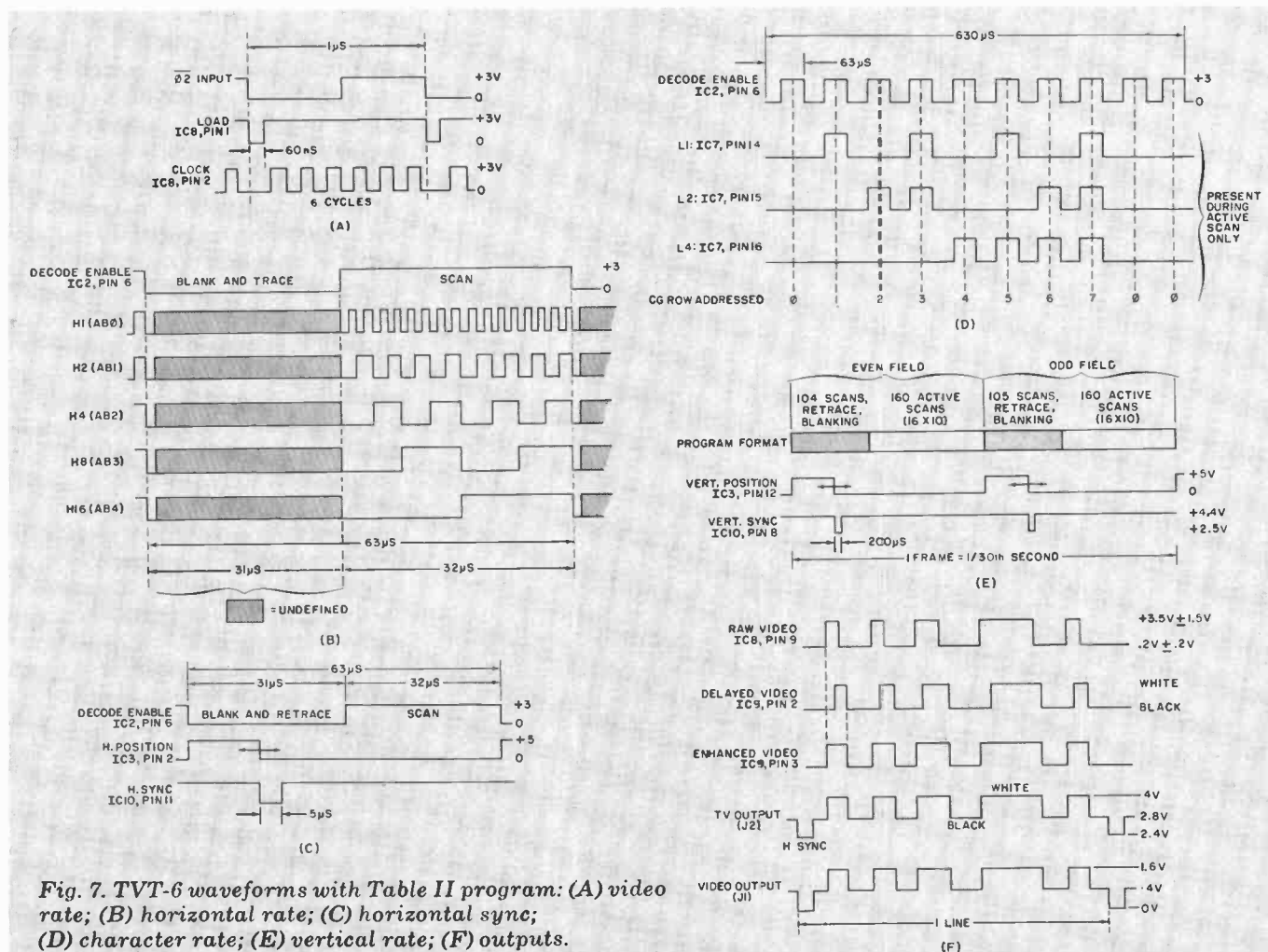

Fig. 7. TVT-6 waveforms with Table II program: (A) video rate; (B) horizontal rate; (C) horizontal sync; (D) character rate; (E) vertical rate; (F) outputs.

TABLE II

16 line X 32 character per line Interlaced  
 TVT6 Raster Scan:

μP - 6502                      Start - JMP 17Ad                      Displayed 0200-03PP  
 System - KIM-1                      End - Interrupt                      Program Space 1780-17E2

HS	VS	L4	L2	L1	0	1	VB	V4	V2	V1	H16	H8	H4	H2	H1
Upper Address								Lower Address							

1780	NOP	EA															Equalize 2 cycles
1781	STA	8d (8A)	(17)														Store upper address
1784	PHA	48															Equalize 10 cycles
1785	PLA	68															Continued
1786	BNE	d0 00															Continued
1788	JSR	20 00	80														Character Scans 1-8
178b	ADC	69 08															Increment Character Scan Counter
178d	CMP	C9 00															Is VS = 1?
178F	BCC	90 P0*															No, do next character scan
1791	JSR	20 (80)	(17)														Equalize 15 cycles via sub
1794	JSR	20 00	80														Character Scan 9
1797	TAX	AA															Save Upper Address
1798	LDA	Ad (89)	(17)														Get Lower Address
179b	ADC	69 1F															Increment L; Set C on V4 overflow
179d	STA	8d (89)	(17)														Restore lower word; save carry
17A0	TXA	8A															Get Lower Word
17A1	BNE	d0 00															Equalize 5 cycles
17A3	NOP	EA															continued
17A4	ADC	69 00															Add carry; Reset VS
17A6	JSR	20 00	80														Character Scan 10
17A9	CMP	C9 84															Is it line "17"?
17Ab	BCC	90 d3*															No, continue character scans
17Ad	LDA	Ad (dF)	(17)														Get Interlace word
17b0	EBR	49 80															Change field
17b2	BMI	30 05*															Jump if even field
17b4	STA	8d (dF)	(57)														Odd Field V Sync; Restore Interlace word
17b7	LDX	A2 66															Load short number of VB scans
17b9	JSR	20 (E0)	(17)														Equalize 15 cycles via sub
17bc	JSR	20 (E0)	(17)														Equalize 15 cycles via sub again
17bf	BPL	10 05*															Jump if odd field
17C1	STA	8d (dF)	(57)														Even Field V Sync; restore interlace
17C4	LDX	A2 67															Load long number of V Blank scans
17C6	JSR	20 1E	80														1st V blanking scan
17C9	CLD	d8															Equalize 9 cycles
17CA	PHA	48															Continued
17Cb	PLA	68															Continued
17CC	LDA	A9 00															Initialize lower address
17CE	STA	8d (89)	(17)														Continued
17d1	LDA	A9 82															Initialize upper address
17d3	STA	8d (8A)	(17)														Continued
17d6	JSR	20 00	80														Remaining V Blanking scans
17d9	CLC	18															Initialize carry
17dA	DEX	CA															One less scan
17db	BMI	30 A4*															Start Character scan
17dd	BPL	10 Ed*															Repeat Vertical blanking scan
17dF		80															Interlace word storage
17E0	BCS	b0 00															Equalize 15 SUBROUTINE
17E2	RTS	60															Continued.

NOTES: TVT6 must be connected and scan microprogram PROM (IC1) must be in circuit for program to run.

Both 17b4 and 17C1 require that page 17 be enabled when page 57 is addressed. This is done automatically with KIM-1 circuitry.

Step 1788 goes to where the upper address stored in 178A and the lower address stored in 1789 tells it to. Values in these slots continuously change throughout the program.

For a 525-line system, use 17b8 64 and 17C5 65 and a KIM-1 crystal of 992.250 kHz. This is only needed for video superposition and titling applications.

Normal program horizontal frequency 15,873.015 Hz; Vertical frequency 60.0114 Hz. 63 us per line; 264.5 lines.

\* Denotes a relative branch that is program length sensitive.

( ) Denotes an absolute address that is program location sensitive.

TVT6 length jumper must be in "32" position.

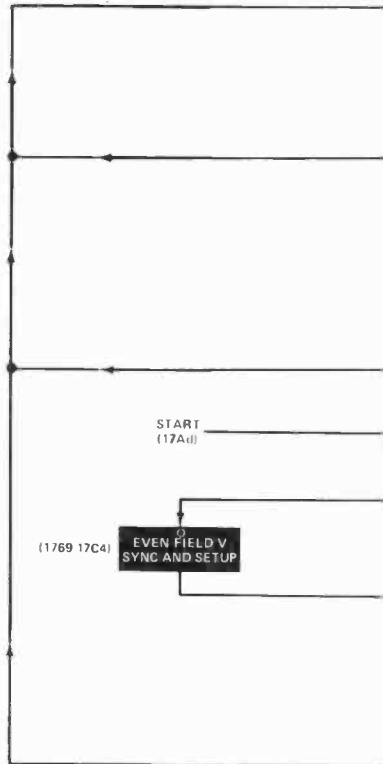

is required. Keep in mind that the KIM-1 has some operating system slots in the top of page zero and the stack at the top of page one. Unless you actually want to display the stack and operating system parameters, do not use these slots.

The 64-character line makes the TV receiver's horizontal frequency run considerably lower than normal. This will require a readjustment of the horizontal-hold control or some extra capacitance across the existing horizontal-hold capacitor. The width of the raster may also have to be reduced; this is most easily accomplished by adding a low-value inductor in series with the yoke. These changes are best made in a small-screen, transformer-powered monochrome TV receiver. The tradeoff of a lowered horizontal frequency produces a long character line but still allows 1 μs/character. This will not tax the bandwidth restrictions of TV receivers or rf modulators. (Editor's Note: The small-screen Sears TV receiver we used required adjustment of horizontal size and linearity, a 0.033-μF Mylar capacitor in parallel with the 0.068-μF capacitor used for C408 in the receiver, and an inductor consisting of 60 turns of No. 24 enameled wire on a 1/2" Nylon form in series with the red yoke lead in the receiver. In addition, it was necessary to disconnect one side of C201 in the receiver

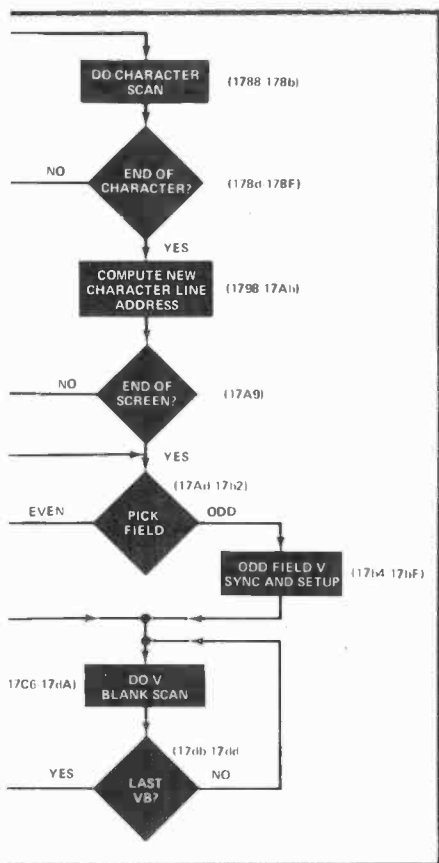

to defeat the sound trap. Never attempt to modify a TV receiver that is powered directly from the ac line without an isolating transformer.)

Table V contains a program that we call "Cruncher the Bear." This program produces 64 fully interlaced characters in each of 32 rows, for a total of 2048 sharp ASCII characters on-screen at one time within the 3-MHz bandwidth. You can add a hex-to-ASCII converter that slowly sequences high- and low-order machine code characters in the same slot and end up with 4096 hex characters displayed in only 3 MHz of bandwidth.

Table V requires a contiguous 2k of memory with a common upstream tap and separate chip enables. However, it is easily incorporated if you really want or need to display as many characters as the program allows.

Other software is easily written and developed for the TVT-6. For example, you may wish to have a 32 x 44 or a 32 x 48 character display and still use normal, or nearly normal, horizontal scanning rates. This allows for video titling and superimposition, oversize characters, color graphics, lower-case characters, and game displays. There is no lower limit to the number of character rows or characters per line you can use. If you have limited memory available,

Table III

16 X 32 Full-performance Cursor:

μP -- 6502 Start -- IRQ Displayed 0200-03FF  
System -- KIM-1 End --- RTI Program Space 0100-01dF

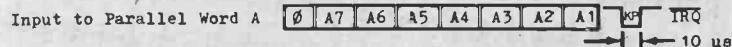

- Clear - CAN (18)
- Carriage Return - CR (0d)
- Cursor Up - VT (0b)
- Cursor Down - LF (0A)
- Cursor Left - BS (08)
- Cursor Right - HT (09)
- Cursor Home - SOH (0A)
- Scroll Up - DC1 (11)
- Erase to End - DC2 (12)
- Spare Hook - DC3 (13)
- Enter -- All characters
- Ignore -- All other CTRL

```

Enter via
  IRQ
  0100 PHA 48
  0101 LDY A0 00
  0103 LDA A5 (EE)
  0105 CMP C9 03
  0107 BEQ F0 04*
  0109 CMP C9 02
  010b BNE d0 3A*
  010d LDA b1 (Ed)
0147 010F AND 29 7F
  0111 STA 91 (Ed)
  0113 LDA Ad 00
  0116 CMP C9 20
0142 0118 BCS b0 28*
  011A CMP C9 18
015E 011C BEQ F0 40*
  011E CMP C9 0d
0152 0120 BEQ F0 30*
  0122 CMP C9 0b
0194 0124 BEQ F0 6E*
  0126 CMP C9 0A
0166 0128 BEQ F0 3C*
  012A CMP C9 09
0158 012C BEQ F0 2A*
  012E CMP C9 08
01A7 0130 BEQ F0 75*
  0132 CMP C9 01
0147 0134 BEQ F0 11*
  0136 CMP C9 11
0175 0138 BEQ F0 3b*
  013A CMP C9 12
014A 013C BEQ F0 0C*
  013E CMP C9 13
01b1 0140 BEQ F0 6F*
  0142 JSR 20 (D3) (01)
  0145 BNE d0 03*
  0147 JSR 20 (C2) (01)
  014A LDA b1 (Ed)
  014C ORA 09 80
  014E STA 91 (Ed)
  0150 PLA 68
←Out 0151 RTI 40
  0152 LDA A5 (Ed)
  0154 ORA 09 1F
  0156 STA 85 (Ed)
  0158 JSR 20 (d5) (01)
  015b JMP 4C (45) (01)
  015E JSR 20 (C2) (01)
  0161 JSR 20 (Cb) (01)
0147 0164 BEQ F0 E1*
  0166 LDA A5 (Ed)
  0168 CLC 18
  0169 ADC 69 20
  016b STA 85 (Ed)
  016d BCC 90 03*
  016F JSR 20 (d9) (01)
  0172 JMP 4C (45) (01)
  0175 JSR 20 (C2) (01)
  0178 LDY A0 20
  017A LDA b1 (Ed)
  017C LDY A0 00
  017E JSR 20 (d3) (01)
  0181 BNE d0 P5*
  0183 CLC 18
  0184 LDA A9 01
  0186 STA 85 (EE)
  0188 LDA A9 E0
  018A STA 85 (Ed)
014A ←018C BCS b0 bc*
  018E STA 85 (bc)

```

(Continued on next page.)



Table III (Continued)

018E	JSR	20	(Cb)	(01)	Clear last line
0191	SEC	38			Set Carry
0192	BCS	b0	FO*		Restore Cursor to start of last line
0194	LDA	A5	(Ed)		/// Cursor Up/// Get Cursor
0196	SEC	38			Set Carry
0197	SBC	E9	20		Move up one line
0199	STA	85	(Ed)		Restore Cursor
014A ←	019b	BCS	b0	Ad*	Underflow of page?
019d	DEC	C6	(EE)		Yes, decrement page
019F	LDA	A9	01		Set A to Page 1
01A1	CMP	C5	(EE)		Did screen underflow?
014A ←	01A3	BNE	d0	A5*	No, Finish
0147 ←	01A5	BEQ	F0	AO*	Yes, Home Cursor
01A7	DEC	C6	(Ed)		/// Cursor Left/// Decrement Cursor
01A9	LDA	A9	FP		Set A to page underflow
01Ab	CMP	C5	(Ed)		Test for page underflow
019d ←	01Ad	BEQ	F0	EE*	Change Page if off Page
014A ←	01Af	BNE	d0	99*	Finish if on page
01b1	LDA	A5	(EE)		/// Erase to EOS/// Get Cursor
01b3	PHA	48			Save Upper cursor location
01b4	LDA	A5	(Ed)		Get lower cursor location
01b6	PHA	48			Save lower cursor location
01b7	JSR	20	(Cb)	(01)	Clear to End of Screen
01ba	PLA	68			Get lower cursor location
01bb	STA	85	(Ed)		Restore lower cursor
01bd	PLA	68			Get upper cursor location
01be	STA	85	(EE)		Restore upper cursor
014A ←	01c0	BNE	d0	88*	Finish
01c2	LDA	A9	00		/// SUB/// Home Cursor/// Set lower cursor to zero
01c4	STA	85	(Ed)		Put page 2 in A
01c6	LDA	A9	02		Set upper cursor to 0200
01c8	STA	85	(EE)		
01cA	RTS	60			Return to main program
01cB	LDA	A9	20		/// SUB/// Enter Space/// Enter space via Sub
01cD	JSR	20	(d3)	(01)	Repeat if not to end
01d0	BNE	d0	F9*		
01d2	RTS	60			Return to main program
01d3	STA	91	(Ed)		/// SUB/// Enter, Increment/// store
01d5	INC	E6	(Ed)		Increment Cursor
01d7	BNE	d0	06*		Overflow?
01d9	INC	E6	(EE)		Yes, Increment cursor page to 03
01db	LDA	A9	04		Load A with page 4
01dd	CMP	C5	(EE)		Test for Overflow
01df	RTS	60			Return to main program

NOTES: IRQ vector must be stored in 17FE 00 and 17FF 01.

Total available stack length is 32 words. Approximately 16 are used by operating system, cursor, and scan program. Stack must be initialized to 01FF as is done in KIM-1 operating system. For 30 additional stack locations, relocate subroutines starting at 01c2 elsewhere.

To protect page, load 00F3 04. To enable entry load 00F3 00.

Cursor address is stored at 00Ed low and 00Ee high on page zero.

To display cursor load 014d 80. To not display cursor load 014d 00.

\* Denotes a relative branch that is program length sensitive.

( ) Denotes an absolute address that is program location sensitive.

you can run 8 × 32, 4 × 64, 1 × 64, or even 1 × 8 character formats. All this takes is software changes, and the circuitry of the TVT-6 remains the same.

**Initial Debugging.** At this point, there should be no IC's in the sockets of the TVT-6 board assembly. Start by connecting the LENGTH jumper to 32 and the CURSOR jumper to YES on the TVT-6 board. (Note: These points are pads located at the center of the circuit board, not the edge-connector contacts.) Temporarily insert a jumper wire between

pins 3 and 14 on the IC5 socket. Center the two position control potentiometers and install IC1, IC2, and IC6 in their respective sockets.

Connect your video monitor to the TVT-6 board and power up the system. Check for the presence of the SCAN instructions (see PROM Truth Table in Fig. 1 of Part 1) at hex locations 8000 through 8020. Write a simple program that jumps to a subroutine at location 8000 and then loops. Single-step through this program to verify proper operation of the SCAN instruction. Do not

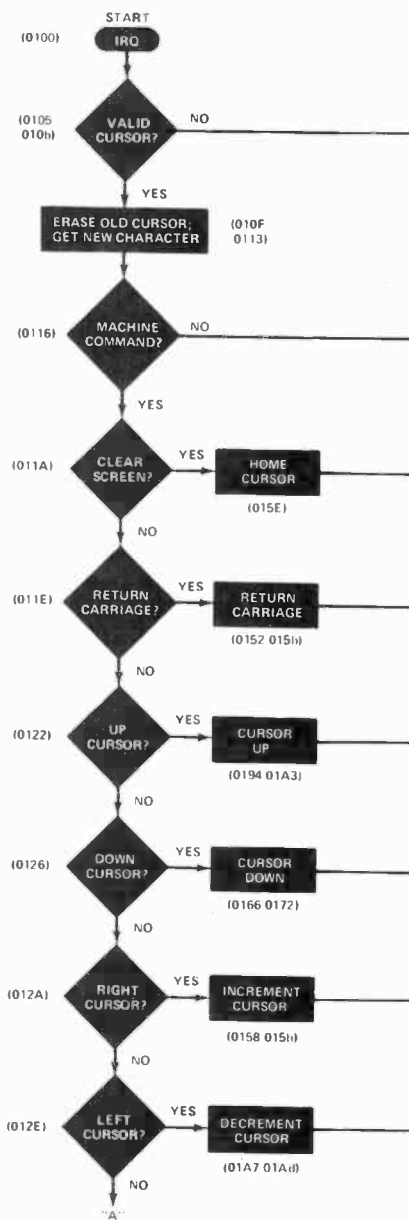

### USING THE TVT-6 WITH OTHER POPULAR MICROPROCESSORS

Both parts of this article have used the TVT-6 with the 6502 microprocessor-based KIM-1 microcomputer. Here is how to use the TVT-6 in μC's that use other popular microprocessors.

**6800.** The 6800 μP is very similar to the 6502 and, therefore, is easiest to convert. The SCAN microprogram can be LDAB(C6) for words 0 through 30 and RTS(39) for word 31. A literal translation of the tightest part of the SCAN program (1D;1782 through 178C) is: STA(B7); JSR(BD); ADDA(8B); CMPA(81); BCC(24). This routine requires 25 μs to cycle through as compared to the 21 μs required for the 6502.

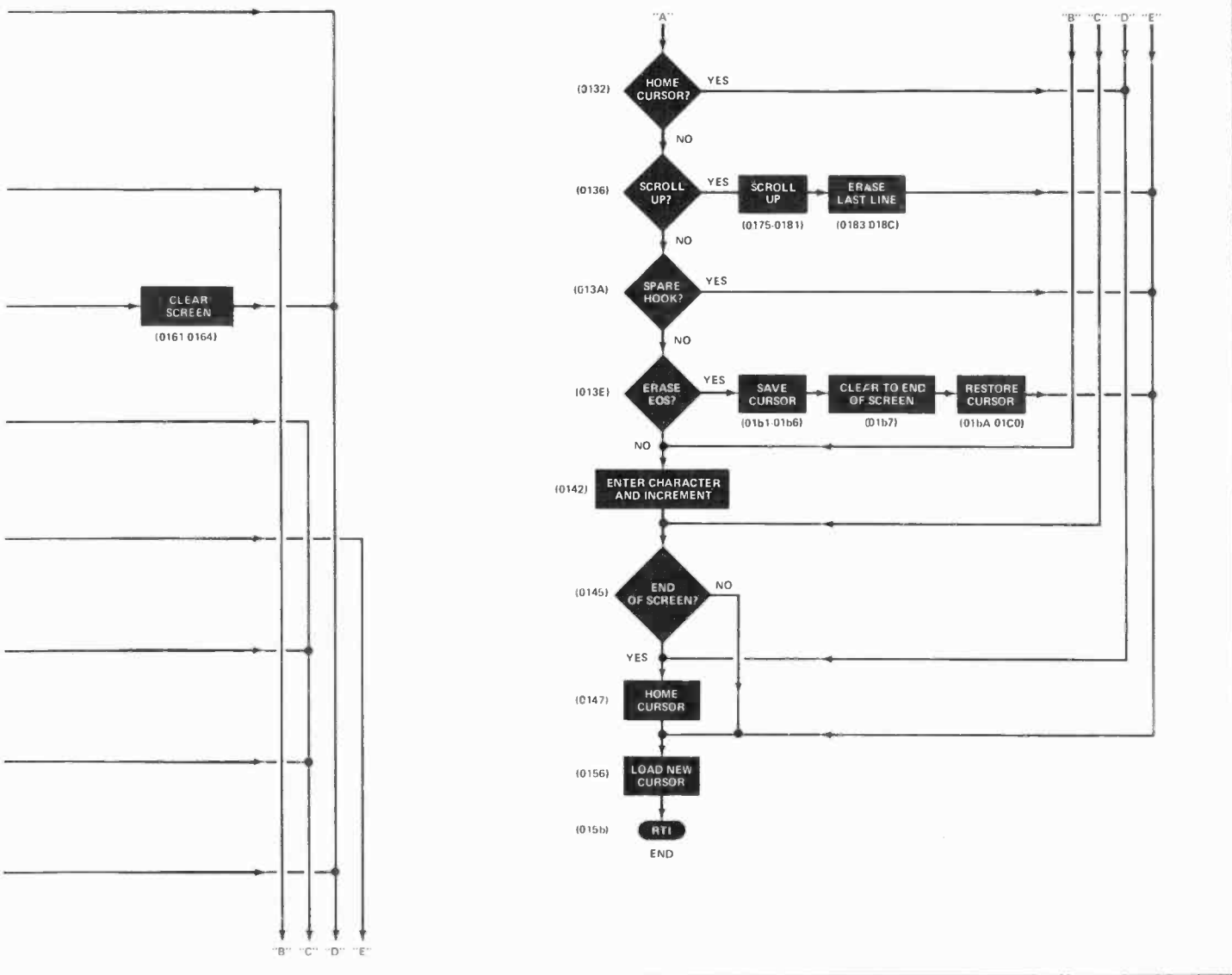

**8080.** A stock 8080  $\mu$ P can normally change its program counter once every 2  $\mu$ s, but it can be "tricked" into doubling its speed during a SCAN microprogram by driving the usual address line A9 of the display memory from SYNC. The SCAN microprogram is then NOP(00) for words 0 through 30 and RET(A9) for word 31. A tighter than literal translation of the SCAN program (1D;1782 through 178C) is: STAXB(02); CALL(AD); ADD(82); CMP(BB); JNC(DB), which requires 24  $\mu$ s to cycle through. Here, the TVT-6 address lines A5 through A1 must be relabelled A4 through A0, respectively.

**Z80.** The Z80  $\mu$ P can use 8080-developed software with speed-doubling scans, or it can simply be run faster, al-

lowing the program counter to change once every microsecond. Use a literal translation of the program for the 6502.

**12 Address Line  $\mu$ P's.** The four upper address lines of 12 address line  $\mu$ P's can be decoded to allow normal operation, 8 to 12 lines of scan, a vertical sync pulse, an operating return system, and an optional "page-change" command. This leaves a 256-character page on the bottom eight bits, and the "page-change" command can be latched to change to any number of additional pages, as required.

**General Hints.** Horizontal scan should last at least 62, 63.5, or 64  $\mu$ s for conventional horizontal-frequency operation. The microprogram scan must end exactly this number of microseconds lat-

er for each horizontal line in the total scan program. The total number of lines must produce a vertical frequency between 59.9 and 60.1 Hz per field. Note that a portion of the RTS time will be spent during the active (microprogram) scan time. Horizontal scans that last longer than 85  $\mu$ s may make it difficult to obtain TV interface.

You can shorten a blank microprogram active scan by an even number simply by jumping ahead when you call your subroutine. For example, a JSR 8000 may produce a 32-character scan, while a JSR 8002 can produce a 30-character scan. This approach can come in handy when there is a need for equalizing scan lengths between character rows and during vertical retrace.

TABLE IV

16 line X 64 character per line TVT6 Raster Scan:

μP - 6502      Start - JMP 17AA      Displayed 0000 - 03FF  
 System - KIM-1      End - Interrupt      Program Space 1780-17bE

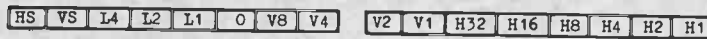

	Upper Address	Lower Address	
1780	LDA A9 80		Initialize Upper Address
1782	STA 8d (87) (17)		Store Upper Address
1785	JSR 20 00 80		////Character Scans 1-8////
1788	ADC 69 08		Increment character scan counter
178A	CMP C9 C0		Is VS = 1?
178C	BCC 90 F4*		No, Do next character scan
178E	TAX AA		Save Upper Address
178F	LDA Ad (86) (17)		Get lower address
1792	BCS b0 00		Equalize 3 cycles
1794	JSR 20 04 80		////Character Scan 9////
1797	BCS b0 00		Equalize 3 cycles
1799	ADC 69 3F		Increment Lower; Set C on V2 overflow
179b	STA 8d (86) (17)		Restore Lower Address; save carry
179E	TXA 8A		Get upper address
179F	JSR 20 00 80		////Character Scan 10////
17A2	ADC 69 C0		Add Carry; Reset VS
17A4	CMP C9 84		It is "Line 17"?
17A6	BCC 90 dA*		No, continue character scans
17A8	BCS b0 00		Yes, Go to vertical blanking scans
17AA	CLD d8		Equalize 2 cycles
17Ab	JSR 20 00 C0		////Vertical Sync Scan////
17AE	LDX A2 22		Load #V Blank Scans -2
17b0	LDA A9 00		Initialize Lower Address
17b2	STA 8d (86) (17)		Continued
17b5	CLC 18		Equalize 2 cycles
17b6	BCS b0 00		Equalize 2 cycles again
17b8	JSR 20 00 80		////Vertical Blanking Scans////
17bb	DEX CA		One less scan
17bC	BMI 30 C2*		Start Character Scan
17bE	BPL 10 F5*		Repeat Vertical Blanking scans

NOTES: TVT6 must be connected and scan microprogram PROM (IC1) must be in circuit for program to run

Step 1785 goes to where the upper address stored in 1787 and the lower address stored in 1786 tells it to. Values in these slots continuously change throughout the program.

Normal program horizontal frequency is 11,764.705 Hz. Vertical Frequency is 60,024 Hz. 85 us per line; 196 lines. Character time 1 us. 160 active lines, 36 retrace. Needs TV set adjustment and possible modification (hold and width).

\* Denotes a relative branch that is program length sensitive.

( ) Denotes an absolute address that is program location sensitive.

TVT6 length jumper must be in "64" position.

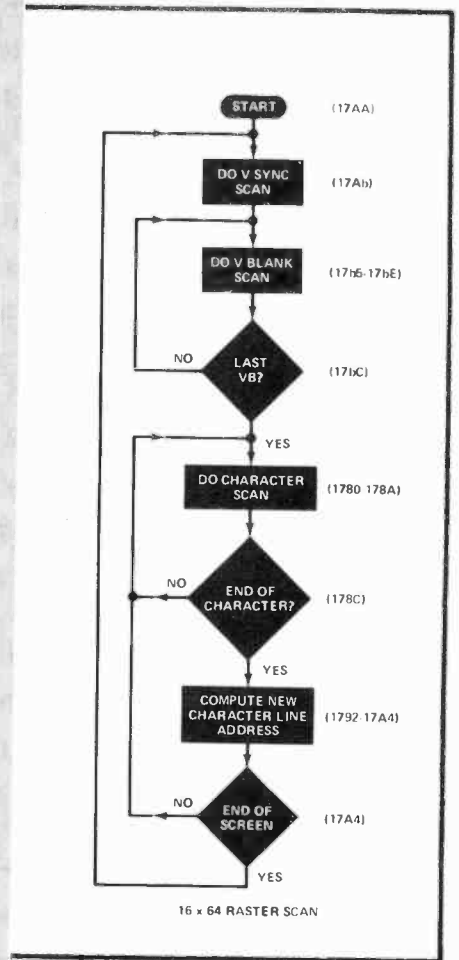

proceed beyond this point until you are certain that the SCAN subroutine is operating properly. (Critical waveforms to be observed with an oscilloscope are illustrated in Fig. 7 using the program listed in Table II.)

Insert IC3 into its socket and load the program given in Table II. (Never install an IC in a powered circuit; always turn off the power, install the IC, and power up again.) Set the address to 17Ad and depress GO. Using an oscilloscope, check at test point VR for the presence of a 60-Hz pulse. Switch the scope to line-sync and observe that the pulse remains fixed or drifts very slowly across the screen. Again, do not proceed until you are certain that the SCAN program is operating properly.

Install all remaining IC's, except IC5, in their respective sockets on the TVT-6 board. At this point, the screen should be filled with a stable display of 512 cursor boxes. Viewed up close, the boxes should appear to be "hiding" characters. Do not proceed until you have the indicated display.

Checking with Fig. 7, particularly with respect to the LOAD and CLOCK on IC8 (Fig. 7A) verify whether or not the appropriate waveforms are present. If they are, remove the jumper wire from the IC5 socket and install IC5. Now, the screen of the monitor should have displayed on it a full array of characters with about half of them winking cursor blocks. Load the following hex numbers into memory, starting at location 0200:

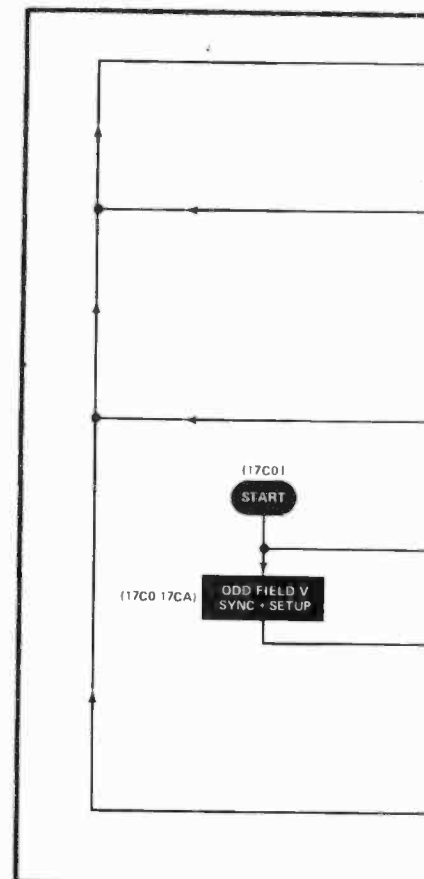



20, 20, 20, 50, 4F, 50, 55, 4C, 41, 52, 20, 20, 45, 4C, 45, 43, 54, 52, 4F, 4E, 49, 43, 53, 20, 20, 54, 56, 54, 2D, 36, 20, 20. Return to address 17Ad and depress GO. The top display line should now read "POPULAR ELECTRONICS TVT-6" and be indented three spaces. If all is well to this point, you can begin feeding in your cursor programs, add external keyboard and/or cassette loads and dumps, etc.

Should you encounter problems with your TVT-6, always begin debugging by using the 16 x 32 format on a KIM-1, even if you plan on using longer line lengths or plan to translate the code into another coding system. Note that the translation *must* be at the machine-language level because the SCAN program must provide the exact number of machine cycles as well as the proper sequencing. The 64-character lines will require some adjustments to be made in the monitor TV receiver's horizontal circuit as detailed earlier.

**Closing Remarks.** We have presented here full construction and operating details for a very versatile and inexpensive TV typewriter for use with the KIM-1 microcomputer. If you have a computer that uses a microprocessor other than the 6502 used in the KIM-1, we refer you to the box for use details. ◇

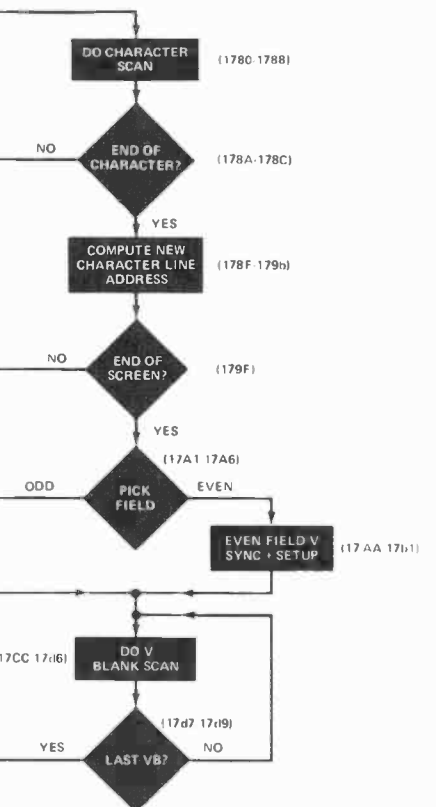

TABLE V

CRUNCHER THE BEAR Program for a 32 line X 64 character per line TVT6 raster scan:

μP - 6502      Start - JMP 17C0      Displayed 0000-07FF  
 System - KIM-1      End - Interrupt      Program Space 1780-17dA

HS	VS	L4	L2	L1	V16	V8	V4	V2	V1	H32	H16	H8	H4	H2	H1
----	----	----	----	----	-----	----	----	----	----	-----	-----	----	----	----	----

Upper Address

Lower Address

```

1780 LDA A9 80      Initialize Upper Address
1782 STA 8d (87) (17)      Store Upper Address
1785 JSR 20 00      80      ///Character Scans 0-7///
1788 ADC 69 10      Increment Character Gen by 2

178A CMP C9 C0      Is VS = 1?
178C BCC 90 P4*      No, Do next character scan
178E PHA 48      Save Upper Address
178F LDA Ad (86) (17)      Get Lower address

1792 ADC 69 3F      Increment L; Set Carry on V2 overflow
1794 STA 8d (86) (17)      Restore L; Save carry
1797 PLA 68      Get Upper Word
1798 JSR 20 0C      80      ///Character Scans 8,9 ///

179b ADC 69 C0      Add Carry; Reset Upper Address
179d CMP C9 88      Is it "Line 33"?
179F BCC 90 E1*      No, repeat Character Scans
17A1 LDA Ad (81) (17)      Get Interlace word

17A4 ADC 69 78      Set Carry if Odd Field finished
17A6 BCC 90 0C*      Start Even Field if Carry Clear
17A8 LDX A2 22      Load Even number of V Scans -2
17AA LDA A9 80      Load Even Field Upper Start

17AC STA 8d (81) (57)      Even Field V Sync + Restore Interlace
17AF LDA A9 88      Even Field Line 33 CMP Value
17b1 STA 8d (9E) (17)      Store Even 33 CMP Value
17b4 LDA A9 00      Clear Accumulator

17b6 STA 8d (86) (17)      Initialize Lower Address
17b9 LDY A0 06      Equalize 31 cycles
17bb DEY 88      continued
17bc BPL 10 Fd      continued

-START → 17bE BCS b0 0C*      Jump if even field
17c0 LDA A9 88      Load Odd Field Upper Start
17c2 STA 8d (81) (57)      Odd Field V Sync + Restore Interlace
17c5 LDA A9 90      Odd Field line 33 CMP Value

17c7 STA 8d (9E) (17)      Store Odd 33 CMP Value
17CA LDY A2 23      Load Odd number of V Scans
17CC JSR 20 3F      80      /// 1st V Blanking Scan ///
17cf PHA 48      Equalize 7

17d0 PLA 68      continued
17d1 CLD d8      Equalize 4
17d2 CLC 18      continued
17d3 JSR 20 00      80      /// Other V Blanking Scans ///

17d6 DEX CA      One Less scan
17d7 BMI 30 A7*      Start Character Scans
17d9 BPL 10 F6*      Repeat V Blanking Scan
  
```

**NOTES:** TVT6 must be connected and scan microprogram FROM IC1 must be in circuit for program to run. TVT6 length jumper must be in "64" position.

Step 1785 goes to where the upper address stored in 1787 and the lower address stored in 1789 tells it to. Values in these slots continuously change throughout the program.

Step 1781 is 80 for even fields and 88 for odd fields. Step 179E is 88 for even fields and 90 for odd fields.

Both 17AC and 17C2 require that page 17 be enabled when page 57 is addressed. This is done automatically with KIM-1 circuitry.

Note that 2K worth of contiguous memory from 0000 to 07FF is needed. This takes a KIM-1 modification. Both sets of 1k words must share a common upstream tap but be separately enabled.

Normal program horizontal frequency is 11,764.705 Hz. Vertical Frequency is 59.8712 Hz. For 60 Hz vertical use 1.002150 MHz crystal. 85 us per line; 196.5 interlaced lines per field; two fields per frame. One us character time, 160 active lines per field. Needs TV set adjustment and possible modification (hold and width).

\* Denotes a relative branch that is program length sensitive.  
 ( ) Denotes an absolute address that is program location sensitive.

## HOW TO CONVERT A "FOUR BANGER" FOR STOPWATCH FUNCTIONS

BY CHARLES STANFORD

**M**OST low-cost "four-banger" calculators can be converted to provide a stopwatch function with 0.1-second resolution by adding the inexpensive three-IC circuit described here. The circuit in no way alters the normal operation of the calculator. It provides crystal-controlled accuracy of 0.05% or better and has a drain of 3 mA or less.

The timer circuit can be added to any calculator that has an automatic-constant feature on the addition (+) function. Once installed, it can be used to time virtually any event from a race to developing a photograph to baking a cake. In addition, you can even convert directly to miles or kilometers/hour, feet/minute or second, etc. For example, you can check the accuracy of your car's speedometer by clocking a measured mile and dividing the time in seconds into 3600 to find the average miles/hour.

**About the Circuit.** Many low-cost calculators can be converted to provide

the timing function—including some calculators with memory and other high-level functions. The only requirement is the automatic-constant feature on the + function. To check whether or not your calculator has this feature, key in ., 1, +, =, =, =. If your calculator has the automatic-constant feature, 0.3 should appear in the display. If the reading remains at 0.1, the calculator cannot be used.

The circuit shown in Fig. 1 consists of a 5369 CMOS programmable counter-divider IC (*IC1*) with a 3.579545-MHz crystal to deliver a 60-Hz output; a divide-by-six counter (*IC2*); and a CMOS analog switch (*IC3*). Pushbutton switch *S1* enables *IC3* and effectively closes the = key in the calculator 10 times a second. CMOS circuitry provides very low battery drain and allows use of any battery that can deliver 3 to 16 volts.

Integrated circuit *IC1* contains a crystal oscillator amplifier that causes the crystal to resonate, a 16-stage divider, and a fractional divider to provide the

60-Hz output. Presettable divide-by-N counter *IC2* is set to divide by 6 by connecting pin 6 to pin 1. The output of this IC, taken at pin 13, is a 10-Hz square wave. Quad bilateral switch *IC3* transmits an input signal to the output only when it is triggered. With the 10-Hz signal from *IC2* connected to the toggle pin of *IC3*, and the = key in the calculator connected to the switch contacts, the = function is initiated 10 times/second.

The timer function takes control of the calculator only when *S1* is closed. With *S1* open, the calculator operates in its normal manner.

**Construction.** The timer circuit is best assembled on a small printed circuit board, the etching and drilling guide/component-placement diagram for which is shown in Fig. 2. It is important to use care when mounting the crystal so that it can be bent back to lie flat against *R1*. Alternatively, *R1* can be mounted on the bottom side of the board and the crystal bent back to lie flat on the board itself.

Install the IC's last, and practice safe MOS-handling procedures when handling and soldering the IC's in place. (See MOS-handling article in this issue.) When interconnecting the timer board and calculator circuitry, make absolutely certain that the power leads are connected in proper polarity. If you reverse the power leads, the integrated circuits can be destroyed.

Switch *S1* can be installed anywhere sufficient space is available. (It fits nicely directly opposite the power switch on the Texas Instruments Model TI-1200 calculator this author used, requiring only accurate drilling of a mounting hole in the case. Check the fit of the switch and pc board assembly before drilling any

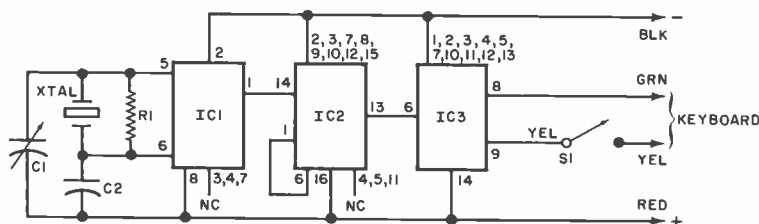

Fig. 1. Timer updates count 10 times/second when constant is activated.

### PARTS LIST

- C1—5-to-40-pF trimmer capacitor
- C2—27-pF ceramic capacitor
- IC1—MM5369 programmable oscillator/divider (National)
- IC2—4018 CMOS presettable divide-by-N counter

- IC3—4016 CMOS quad bilateral switch
- R1—22-megohm, 1/4-watt resistor
- S1—Miniature push-push spst switch
- XTAL—3.579545-MHz (color TV) crystal
- Misc.—Printed circuit board; red, black, yellow, green stranded hookup wire; insulating tape or fish paper; solder; etc.

holes to make sure switch and board will fit in your calculator.

It is best to leave the interconnecting leads a bit long to facilitate easy installation and calibration of the timer circuit. The red (+) lead from the timer goes to any point on the calculator's bus *after* the power switch. The black (-) lead then goes to any point on the calculator's negative bus.

The green and yellow leads connect across the = key in the calculator. The hookup points for the = key can be found by trial and error with the aid of a jumper wire. Simply jumper from one contact to another, after feeding into the calculator (via the keyboard) 1, +, =. When you hit on the right combination, the display will read 2. On calculators with an X-Y matrix keyboard, each lead from a vertical key row initiates a function with each lead from a horizontal row. In the TI-1200, for example, there are nine leads coming from the keyboard, four vertical and five horizontal; the = function is controlled by the first and eighth leads, counting from the left.

After you have identified the appropriate leads for the = key, determine their polarity by using a small diode (a 1N914, for example) in series with the test lead. The function will initiate only when the cathode (banded) end of the diode points toward the negative contact. Connect the green lead from the timer circuit

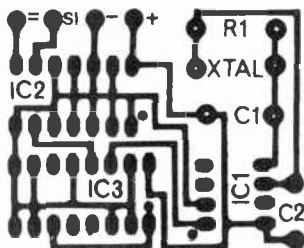

Fig. 2. Foil side, components mount on other side of board. Dots denote pin 1 of IC's.

to the negative contact. The yellow lead then goes to the positive contact on the keyboard. (Note: a very few calculators cannot be keyed at the 300-ohm "on" resistance of IC3; with such calculators, you must connect a 500-to-1000-ohm resistor between pins 8 and 9 of IC3.)

**Calibration.** The timer can be calibrated quickly and easily with the aid of a frequency counter. If a counter is not available, you can use an electric clock with a large sweep second hand and obtain reasonable accuracy, trimming as necessary.

Start calibration with the trimmer capacitor (C1) centered and rotate it about 10° at a time. Ten minutes of timing (600.0 seconds) will provide better than 0.05% accuracy if 10 trials provide results that are within 0.5 second.

Before final assembly, completely insulate the timer board to avoid short circuits between leads or components. Usually, all that is required is to place a layer or two of masking or vinyl tape or a single layer of fish paper on the foil side of the board.

**Using the Timer.** Each time the calculator is turned on for use as a timer, key in the following sequence: ., 1, +. Then, when you depress S1, 0.1 will automatically be added to the display at 0.1-second intervals until S1 is again pressed. For successive timings, pressing the 0 key will clear the display while retaining the + constant. You can also count down from any number by entering the number via the calculator's keyboard, followed by, -, ., 1. If you press the C (clear) key, you must reenter the constant before timing another event.

Another section of IC3 can be used in the 10-Hz line to provide remote actuation of the timer by a gate switch or photocell. This will require the addition of a jack to your calculator, assuming there is room to accommodate it.

The addition of the timing function to an existing calculator is one way of updating a very versatile instrument. The timer actually doubles the usefulness of your calculator by providing a function that is available commercially in only very expensive calculators. ♦

# THE HP-25 AS A DIGITAL CLOCK & TIMER

BY WILLIAM T. PETERS

**T**HE PRECEDING article showed you how to convert an inexpensive four-function calculator to a stopwatch by adding a three-IC circuit. This article describes how to program an HP-25 calculator to make it serve as a clock/timer. The display is in hours, minutes, and seconds, and resolution is to the nearest second.

**The Program.** To set up the HP-25 calculator as a timer, first put the display format into the FIX 4 mode. The display will read 0.0000. Now, switch to the program (PRGM) mode and key in the following sequence:

STEP	KEYSTROKES
01	RCL, 1
02	f, →H.MS
03	f, PAUSE
04	RCL, 2
05	STO, +, 1
06	GTO, 01

Next, switch to the RUN mode and key in: 3600, g, 1/x, STO, 2. Now, when you press the run/stop (R/s) key, the calculator will begin counting in hours, minutes, and seconds (approximately). The two digits preceding the decimal point in the display are the hours; the two digits immediately following the decimal point

are the minutes; and the two digits following the space are the seconds. You will note that the display updates every second as long as the calculator is in the RUN mode.

After a few minutes, you will probably find that your calculator is gaining time. To remedy this, you can add one or more steps to the program by pressing g and then NOP for each step you wish to add. These extra steps can be added anywhere in the program before the final step. Under no circumstances should you attempt to adjust the calculator's internal oscillator, which would void the manufacturer's warrantee.



# TTL LOGIC QUIZ

BY W.J. FISHER

Now your timer will probably be accurate enough for most photographic or kitchen timing. However, with a little further tinkering with the program, you can improve the accuracy to within seconds per day.

**Better Accuracy.** If your calculator is running slow, an increase in the number stored in Register 2 will compensate. If the calculator is running fast, the number in Register 2 will have to be decreased somewhat. For example, assume the timer is running 7 seconds slow after 16 minutes (960 seconds). You can compensate for this by increasing the number in Register 2 by 7/960. Alternatively, if the timer is running fast by 7 seconds, you can decrease the number in register 2 by 7/960.

**Using the Program.** You can use the HP-25 calculator as a stopclock by pressing the R/s key at the beginning of the event you wish to time. Then, at the end of the event, hit the R/s key again to stop the clock. The calculator will display the elapsed time, unless you stopped the clock while it was updating. To read the elapsed time, key in RCL, 1, f, >H.MS.

To use the calculator as a digital clock, simply store the hour, minute, and second from which you wish the calculator clock to start running in register 1. Before storing this number, convert it to a decimal-hour format by pressing g, >H. While the HP-25 displays hours, minutes, and seconds, the timing program "thinks" in decimal fractions of an hour.

A simple program change turns the calculator into a countdown timer. Store the starting time in Register 1 and change step 5 in the program to STO, -1. Now, when the timing program is started, the calculator will count down from the time stored in Register 1, a second at a time.

Several of these countdown timer programs can be stored in the calculator simultaneously. They can be used as required by instructing the calculator to go to (GTO) the first step of the desired program and then pressing R/s to begin timing. In fact, the conditional-function keys make it possible to program the calculator to go from one countdown program to the next automatically, although a small loss in timing precision will be encountered because of increased program length. This is very handy in a darkroom, where several processes of different duration must often be timed in sequence. ◇

Although the circuits shown here can not be put to any practical use, they can provide a test of your TTL IQ. For each circuit, determine the resulting outputs at B for the two possible logic inputs ("1" or "0") at A.

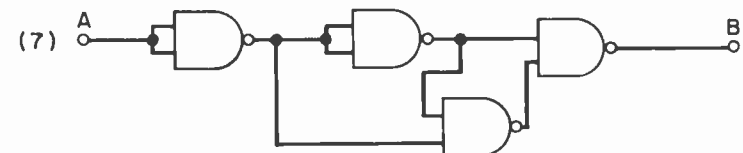
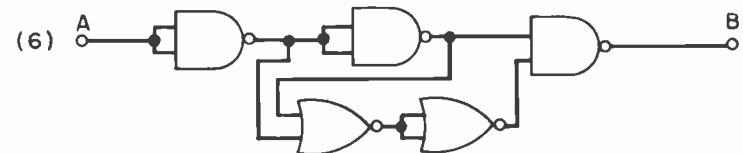
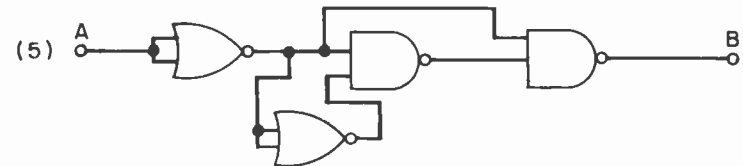
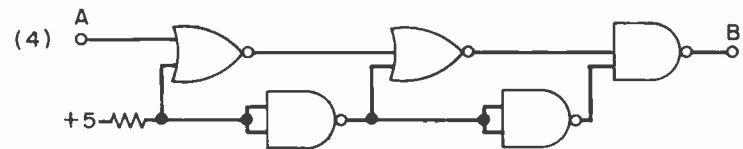
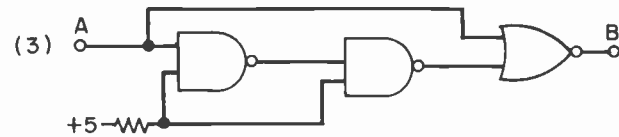
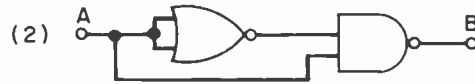
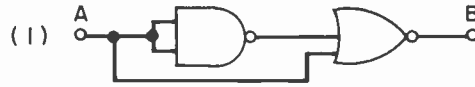

- ANSWERS: (1) A=1; B=0 A=0; B=1  
 (2) A=1; B=1 A=0; B=0  
 (3) A=1; B=1 A=0; B=0  
 (4) A=1; B=0 A=0; B=0  
 (5) A=1; B=1 A=0; B=0  
 (6) A=1; B=0 A=0; B=1  
 (7) A=1; B=0 A=0; B=1

# BUILD A DIGITAL CAMERA SHUTTER TIMER

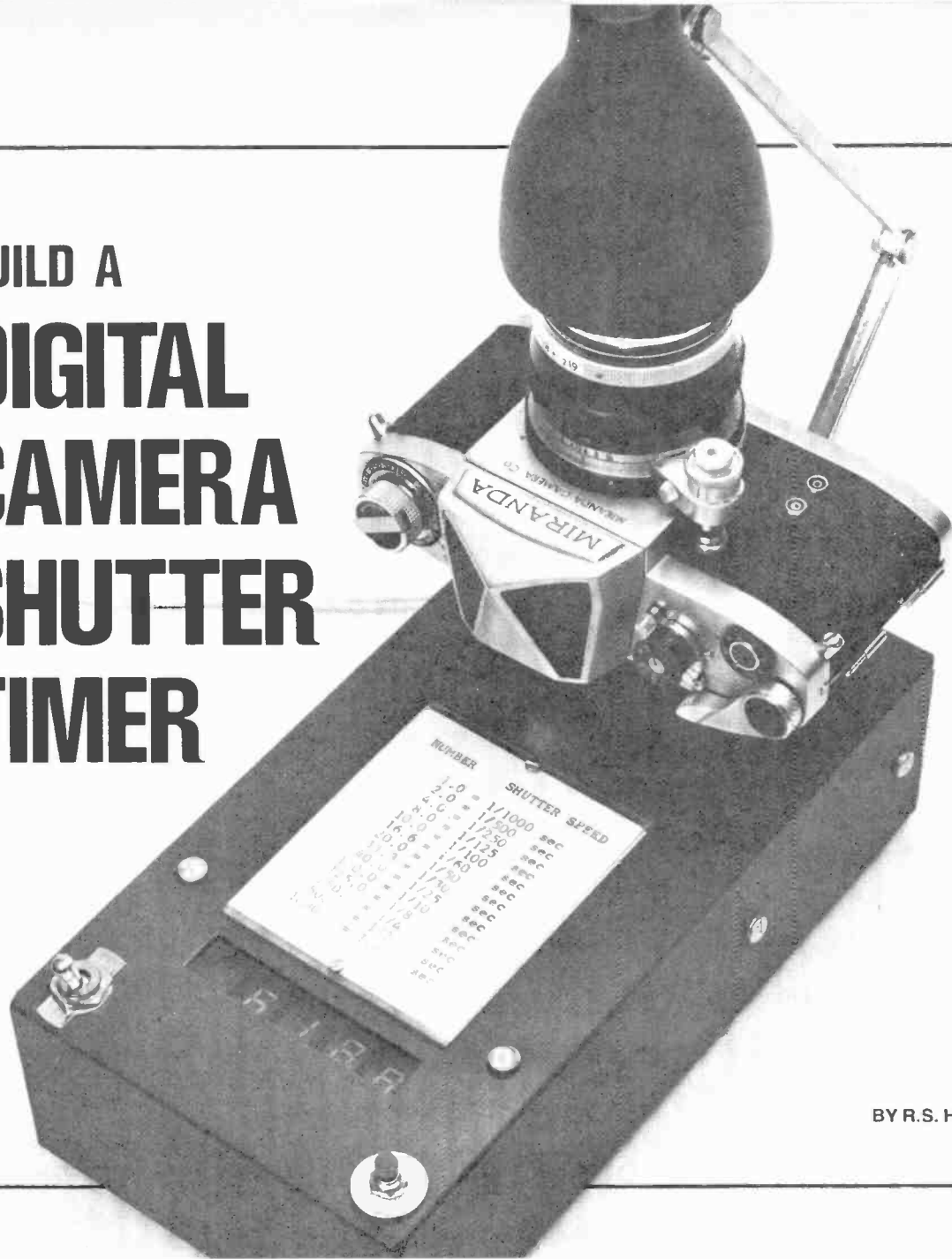

BY R.S. HEDIN

*Low cost digital timer provides accurate check of camera shutter speeds from 1/1000th of a second to 1 second.*

**H**AVE YOU ever wondered why a camera whose diaphragm opening and shutter-speed setting are adjusted perfectly according to an exposure meter should regularly produce overexposed or underexposed negatives or prints? Too often, the cause is a shutter speed that deviates too much from the camera's speed markings.

Now you can check your camera's actual shutter speed by building the electronic shutter tester presented here. If the camera displays a gross speed inaccuracy, you'll know that you must com-

pensate for it by modifying the camera's control adjustments (say, an f stop greater or smaller than the exposure meter's indication) or having the camera serviced professionally.

With your own shutter tester, you can test your camera at any time you feel it needs adjustment. The shutter tester described here uses digital circuits and has six decades of display to give a high order of accuracy.

**About the Circuit.** The sensor/control circuit for the tester is shown in Fig.

1, while the counting circuit is shown in Fig. 2. The two circuits are coupled together via the +V and GND buses and the points marked K going to each other.

When light strikes phototransistor Q2 and not LDR1 in Fig. 1, the Darlington circuit made up of Q2 and ordinary transistor Q1 triggers on and supplies current to timer IC6. This causes the timer IC to generate pulses at a frequency of 10,000 Hz. (Potentiometer R1 is provided for adjusting the operating frequency of the oscillator to exactly 10,000 Hz.)

If at any time light strikes LDR1, the

# Be the “New Professional” in electronics

**CREI trains you at home  
for one of the most important  
career levels in electronics—  
plus offers you special  
arrangements for engineering  
degrees**

Most people think there are only two levels of careers in electronics: the technician level and that of the degree engineer.

There is, however, a third and very important level. It is that of the engineering technician or *practical* engineer. The growing importance of this career level has created what might well be called the “New Professional” in electronics.

If you look at the various levels of employment in electronics, you will understand why this “New Professional” is so important.

The average technician is a person who has had vocational training in electronics. He understands the basic principles of electronics so he can troubleshoot, repair and maintain equipment. He usually works under close supervision in performing his duties.

The engineer has college training in electronics. He usually supervises technician personnel and is responsible for planning and developing of electronic equipment and systems. Frequently, however, engineers are more heavily trained in the scientific principles of electronics and less in their practical application.

The engineering technician, by contrast, is a specialist in the practical application of electronics. His training usually consists of a two-year college program in electronic engineering technology. In many organizations, the engineering technician handles several of the responsibilities of the degree engineer. He often has the title of engineer.

CREI programs are designed to give you at home the same level and depth of training you receive in a two-year college program in electronic engineering technology. CREI programs are, in fact, more extensive than you will find in many colleges. And CREI gives you the opportunity to specialize in your choice of the major fields of electronics.

## **Unique Design Lab**

CREI gives you both theory and practical experience in circuit design with its Electronic Design Laboratory Program. The professional equipment included in this program allows you to construct, test out and correct the circuits you design until you have an effective circuit.

This Lab Program helps you understand advanced electronics. It also gives you practical experience in many other important areas of electronics, as in pro-



## Career Training at Home

prototype construction, breadboarding, test and measurement procedures, circuit operation and behavior, characteristics of electronic components and how to apply integrated circuits.

Only CREI offers the unique Lab Program. It is a complete college Lab and, we believe better than you will find in most colleges. The "Lab" is one of the factors that makes CREI training interesting and effective. And the professional equipment in this program becomes yours to keep and use throughout your professional career after you complete the training.

### Engineering Degree

CREI offers you special arrangements for earning credit for engineering degrees at certain colleges and universities as part of your home study training program. An important advantage in these arrangements is that you can continue your full time job while "going to college" with CREI. This also means you can apply your CREI training in your work and get practical experience to qualify for career advancement.

### Wide Program Choice

CREI gives you a choice of specialization in 14 areas of electronics. You can select exactly the area of electronics best for your career field. You can specialize in such areas as computer electronics, communications engineering, microwave, CATV, television (broadcast) engineering and many other areas of modern electronics.

### Free Book

In the brief space here, there isn't room to give you all of the facts about CREI college-level, home study programs in electronics. So we invite you to send for our free catalog (if you are qualified to take a CREI program). The catalog has over 80, fully illustrated pages describing your opportunities in advanced electronics and the details of CREI home study programs.

### Qualifications

You may be eligible to take a CREI college-level program in electronics if you are a high school graduate (or the true equivalent) and have previous training or experience in electronics. Program arrangements are available depending upon whether you have extensive or minimum experience in electronics.

Send for this **FREE** Book describing your opportunities and CREI college-level programs in electronics



Mail card or write describing qualifications to

**CREI** **CAPITOL  
RADIO  
ENGINEERING  
INSTITUTE**

**McGraw-Hill Continuing Education Center  
3939 Wisconsin Avenue Northwest  
Washington, D.C. 20016**

**Accredited Member National Home Study Council**

### GI Bill

*CREI programs are approved for training of veterans and servicemen under the G.I. Bill.*



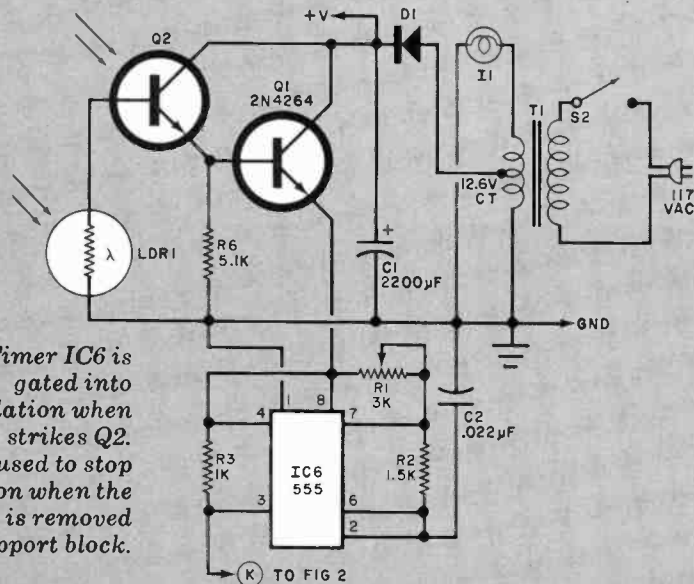

Fig. 1. Timer IC6 is gated into oscillation when light strikes Q2. LDR1 is used to stop operation when the camera is removed from support block.

**PARTS LIST**

- C1—2200-µF, 16-volt electrolytic capacitor
- C2—0.022-µF Mylar capacitor
- DIS1 through DIS5—½" common-anode, seven-segment LED display (DL-704 or similar)
- D1—100-volt, 1-ampere silicon rectifier diode
- I1—12-volt high-intensity lamp with arm and reflector (see text)
- IC1 through IC5—4033A CMOS decade counter
- IC6—555 timer
- LDR1—Light-dependent resistor (Vactec No. VT-214 or Clairex CL-903)
- Q1—2N4264 transistor
- Q2—FPT-100 phototransistor
- R1—3000-ohm trimmer potentiometer

- The following resistors ¼ watt, 10% tolerance:
- R2—1500 ohms
  - R3, R4, R5—1000 ohms
  - R6—5100 ohms
  - S1—Normally open, momentary-action spst pushbutton switch
  - S2—Spst toggle switch
  - T1—12-volt, 1.2-ampere transformer (see text)
- Misc.—Printed circuit or perforated board; 16-pin DIP sockets (5); 14-pin DIP sockets (5); 8-pin DIP socket; chassis with cover (9" × 5" × 2½"); line cord; pine block (3½" × 1¾" × 1¾"); soft vinyl sheet; rubber feet (4); contact cement; machine hardware and spacers; hookup wire; solder; etc.

ter/lens mechanism is positioned directly above Q2, in line with a high-intensity light source. Switch S1 is momentarily depressed to reset the counters to zero. Then, when the shutter is tripped, the system counts the number of pulses generated between the opening and closing of the shutter.

The counting circuit shown in Fig. 2 consists of five decade-counter IC's (IC1 through IC5) and their companion seven-segment displays (DIS1 through DIS5). Note that DIS2 is the only display whose decimal point is active. This decimal point comes on whenever the tester is powered. Note also that the decade counters are wired to suppress the zeroes to the left of the decimal point. Since the display indicates the number of pulses counted during a discrete interval of time, it does not indicate time. To obtain the time indicated by the number in the display, you must divide that number by 1000. Hence, displays of 1.0, 8.0, 16.6, and 33.3 translate to 0.001, 0.008, 0.0166; and 0.0333 second or, in photography terminology, 1/1000, 1/125, 1/60, and 1/30 second, respectively. (It is a good idea to make up a table of conversions that can be affixed to the completed project, as shown in the lead photo.)

The power supply for the tester is line operated. Dc power for the system is obtained from a conventional rectifier-diode/filter-capacitor (D1/C1) setup that is driven from the center tap of transformer T1. This circuit assumes that high-intensity lamp I1 is an integral part of the system. If you prefer, you can use a separate line-powered high-intensity lamp and substitute a 6.3-volt transformer for T1.

**Construction.** The entire circuit, except T1 and the two switches and Q2

resistance in the base circuit of Q2 drops to a low enough value to cause the Darlington circuit to cut off. This, in turn, turns off the timer circuit. Under normal operating conditions, no light will fall on either Q2 or LDR1 initially. After pressing reset switch S1 (Fig. 2), light is allowed to reach only Q2. This allows the timer circuit to generate a 10,000-Hz

pulse output that is counted by the totalizer circuit shown in Fig. 2. The displays continue to count upward until the light to Q2 is interrupted or light falls on LDR1. At this time, the displays "freeze" to indicate the total number of pulses counted. When the tester is used with a camera, the camera's body covers LDR1 to exclude all light and the shut-

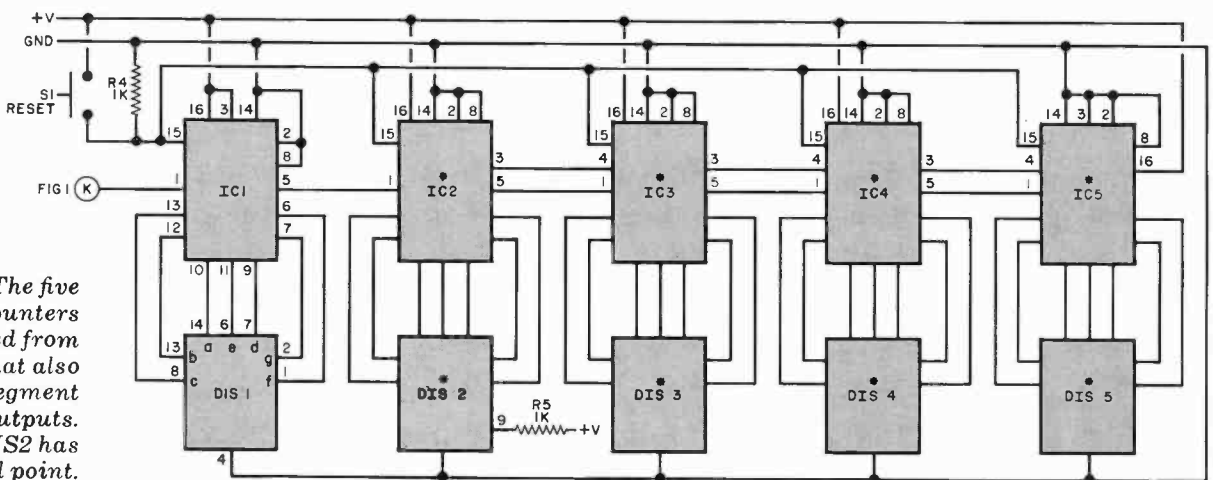

Fig. 2. The five decade counters are formed from IC's that also include 7-segment decoded outputs. Note that DIS2 has the decimal point.

\* SAME AS FOR IC1/DIS 1

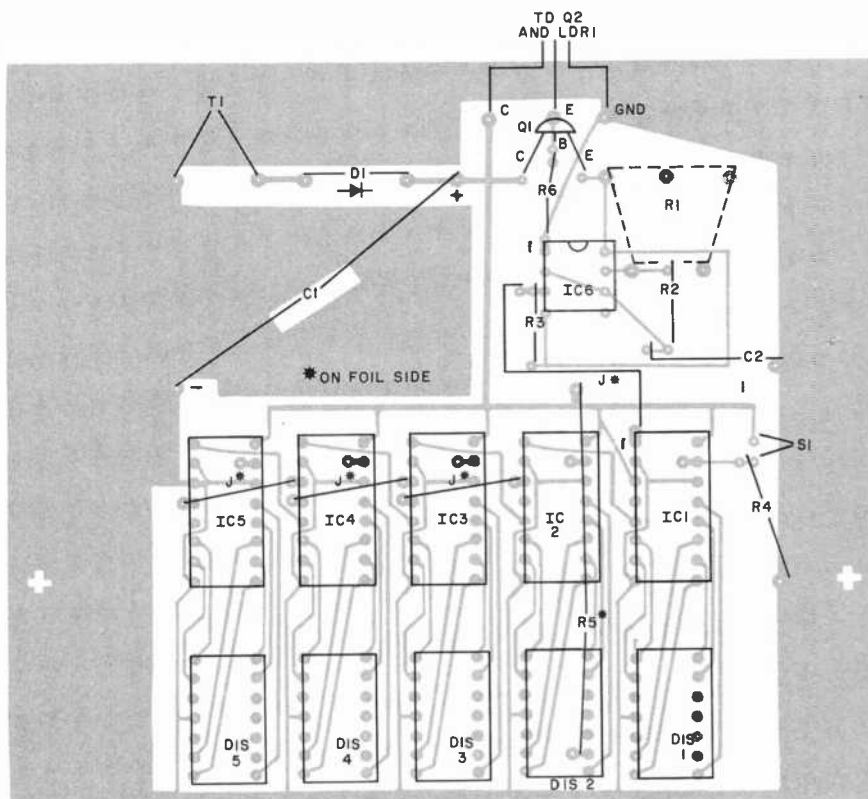

Fig. 3. Foil pattern and component installation. Pin 15 of IC1 through IC5 are connected together by a common jumper on the foil side of the board. Note that R5 and the other jumpers are also located on the foil side.

and LDR1, can be assembled on a single printed circuit board, the etching and drilling and component-placement guides for which are shown in Fig. 3. Alternatively, you can assemble the circuit on perforated board, using appropriate solder hardware. In either case, the use of sockets for the IC's and displays is recommended.

Install the components on the circuit board as shown in the component-placement guide, taking care to properly orient them. Note here that the four jumper wires labelled J and R5 mount on the foil side of the board. To avoid the possibility of short-circuiting the board,

### CONVERSION TABLE

NUMBER SHUTTER SPEED

1.0	=	1/1000	sec
2.0	=	1/500	sec
4.0	=	1/250	sec
8.0	=	1/125	sec
10.0	=	1/100	sec
16.6	=	1/60	sec
20.0	=	1/50	sec
33.3	=	1/30	sec
40.0	=	1/25	sec
100.0	=	1/10	sec
125.0	=	1/8	sec
250.0	=	1/4	sec
500.0	=	1/2	sec
1000.0	=	1.0	sec

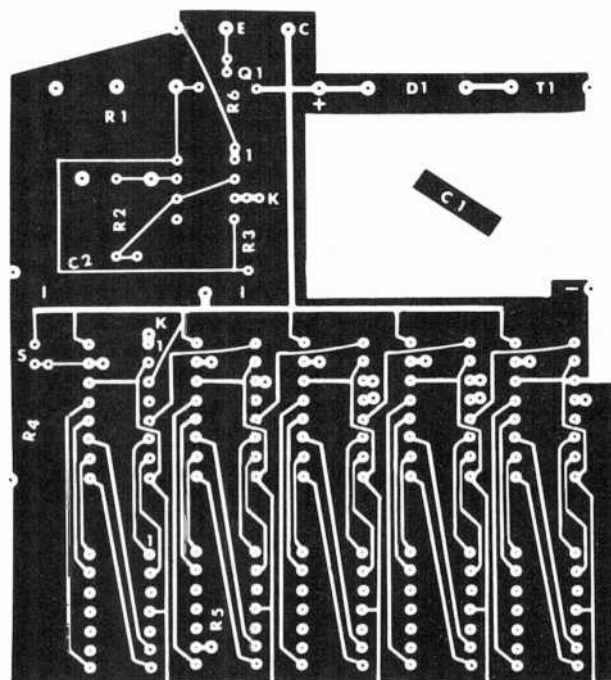

be sure to use insulated sleeving on the resistor leads and wire jumpers.

Phototransistor Q2 and light-dependent resistor LDR1 mount in a block of pine as shown in Fig. 4. The holes in which these two components mount must be stepped as indicated to permit easy routing of the hookup wires that interconnect them with the rest of the circuit. Note that LDR1 mounts in the hole at the lower left corner and Q2 mounts in the hole in the center of the block.

Before you mount Q2 and LDR1 in the block of wood, apply a coat or two of flat black paint to all exterior surfaces of the block. Allow the paint to completely dry, and then mount the components in their respective holes, fixing them in place by force fitting. (If the fit is too snug, very carefully ream out the holes; if it is too loose, sparingly apply a drop or two of clear plastic cement to the component edges. Both components mount flush with the top surface of the block. When



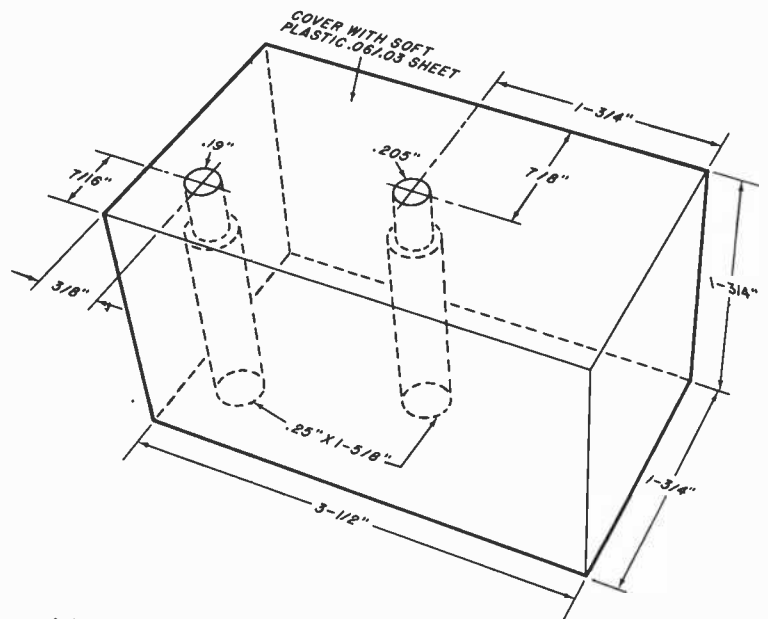
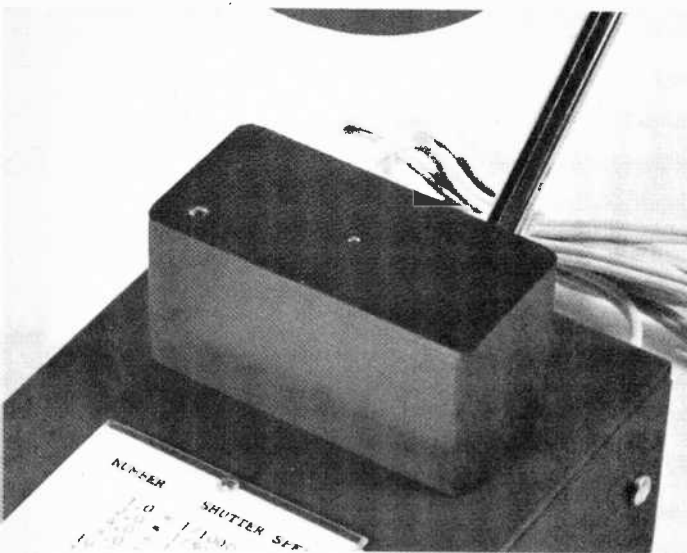

**Fig. 4.** Details of the camera mounting block. The two photosensitive devices (*Q2* and *LDR1*) are mounted close to the upper surface of the block.

this is done, use contact cement to fasten a thin sheet of soft matte black vinyl to the top of the block after first punching holes in it for *Q2* and *LDR1*.

A 9"D × 5"W × 2½"H (22.9 × 12.7 × 6.4 cm) metal box comfortably accommodates the circuit board assembly, power transformer and its line cord, and switches. The case must be machined to provide a 2½" × ½" (6.7 × 1.3 cm) window for the displays; mounting holes for the switches, transformer, and wood block; and access holes for the line cord and leads from *Q2* and *LDR1*. Once the case has been machined, spray two or three coats of matte black paint over all exterior surfaces. When the paint has dried, cement a red filter over the win-

dow from the inside. Then mount the wood block with screws, followed by *T1*, *S1*, and *S2*. Next, interconnect the switches, transformer, line cord (passed through the case via a rubber grommet), *LDR*, and phototransistor. Finally, mount the circuit board assembly in place with machine hardware and spacers, making sure its displays are properly oriented behind the filter.

**Checkout and Use.** Place a piece of black plastic tape over *LDR1*, plug the line cord into a convenient ac outlet, and turn on the tester's power. Now, using an oscilloscope or a frequency counter, adjust potentiometer *R1* for an exact 10,000-Hz output from timer *IC6*. This

completes calibration. Remove the tape from *LDR1*.

Open the back of the camera you wish to test and place it on the wood block so that the lens opening is directly over *Q2*. Make sure that the camera body covers *LDR1*. Then set the camera's lens diaphragm for maximum opening, set the shutter speed, and cock the shutter. Depress reset switch *S1* so that all displays read zero. Trip the camera shutter. The displays should rapidly count up and freeze at a number that is the shutter speed in thousandths of a second.

Check each shutter speed at least three times, resetting the display at the start of each test. The most accurate reading is with the lens on the camera because the light is somewhat collimated. Without a lens on the camera, the light can diffract around the shutter curtain and indicate a longer than actual shutter speed time. This is important at fast shutter speeds when the curtain opening is narrow. This does not pertain to between-the-lens leaf shutters.

Do not be disappointed if your shutter speed is not close to its camera setting. Up to 1/500 of a second, the allowable error may be as great as ±25%; at higher settings, the allowable error might be ±35%. These figures would depend on the tolerance of the film used, of course.

With the aid of the camera shutter timer described here, you can eliminate some of the uncertainties you have about the accuracy of your camera's mechanism. Additionally, it can tell you why your latest batch of photos did not turn out as they should have. ♦

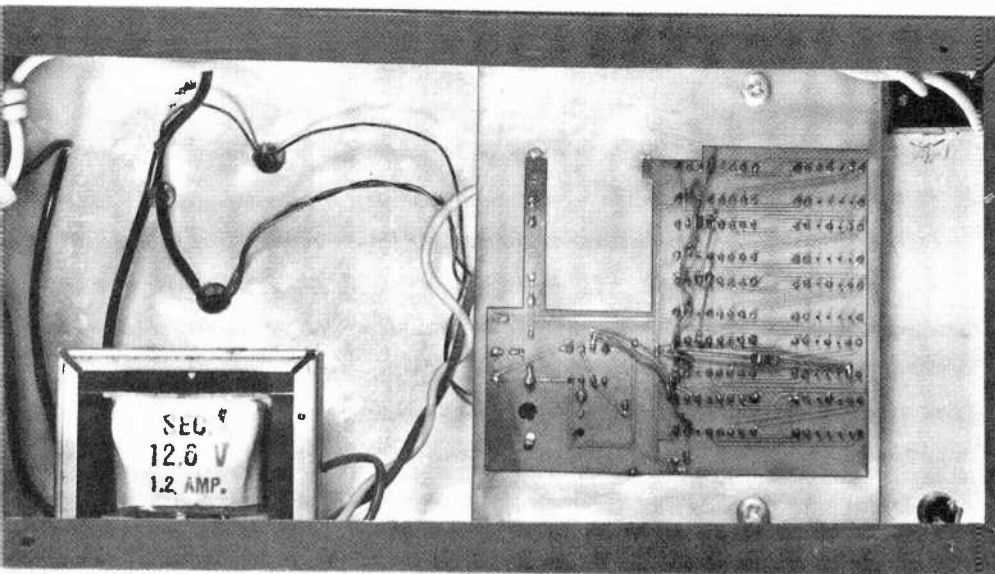

Underside of timer reveals pc board and transformer mounting.



# HOW TO HANDLE MOS DEVICES WITHOUT DESTROYING THEM

*The life span of many MOS devices depends on what happens between the time of purchase and installation.*

BY LESLIE SOLOMON, Technical Editor

**M**OS TECHNOLOGY has brought tremendous advances to modern electronics. However, MOS devices suffer from one fatal shortcoming: they can easily be destroyed by static electricity when they are handled or being installed in a circuit. Even so-called "protected" MOS devices are not immune from being ruined by static electricity if proper precautions are not taken.

In this article, we will discuss the physical makeup of the typical MOS device and see how and why the MOS device is so easily destroyed. Then we will detail some of the steps you can take to prevent destruction of the device.

**MOS Device Construction.** In a circuit, a MOS device "looks" like a voltage-controlled resistor in which the equivalent MOS resistance between the drain and source is varied by a voltage applied to the gate electrode. (See Fig. 1.) Physically, the gate electrode is a thin layer of metal deposited on a very thin (about 1000 Angstroms) layer of silicon dioxide (glass). This layer of glass effectively insulates the gate from the substrate, in essence, forming a capacitor whose plates are the gate and substrate and whose dielectric is the layer of

SiO<sub>2</sub> between the gate and substrate.

The strength of the electrical field that can rupture the SiO<sub>2</sub> layer is about 100 volts, at which point, a "punchthrough" can occur (Fig. 2.) Such a punchthrough catastrophically destroys the MOS device permanently.

Most MOS devices have an input resistance on the order of 10<sup>14</sup> ohms. Using this figure, it can be seen that a current of about 10<sup>-12</sup> ampere (10 pA) can generate a 100-volt potential that can

break through the layer of glass and destroy the device. Some semiconductor manufacturers protect their MOS devices with a variety of circuits, the built-in zener-diode-resistance method being the most common.

The schematic representation of a typical "protected" MOS device is shown in Fig. 3. Note the built-in zener diode that identifies this as a protected device. The "source," "gate," and "drain" electrodes are the equivalent of the "emitter," "base," and "collector" electrodes of the typical bipolar transistor. (The "substrate" lead of the device is usually connected to the source lead.)

In most cases, the zener diode that protects the MOS device conducts at about 50 volts. However, selection of the "substrate resistance" can present a problem. This resistance must be great enough to limit current flow to prevent destruction of the zener diode, but it must not be so high that the sum of the voltage drop across the zener-resistance combination exceeds the breakdown voltage of the SiO<sub>2</sub> layer. Manufacturers are making improvements in their protective schemes, but as of this writing, there is still no such thing as complete protection.

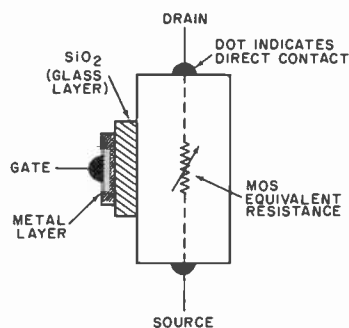

*Fig. 1. Typical MOS device showing the insulated gate.*



Fig. 2. Magnified (4300X) view of a cell-destroying punchthrough that has catastrophically destroyed the semiconductor device.

**Static Charges.** High-voltage static charges are generated whenever there is motion between certain types of materials. A partial listing of typical generators of this "triboelectricity" is given in the table.

## ELECTROSTATIC CHARGE GENERATORS

### Workbench Covering

- Any plastic (except conducting)
- Finished wood
- Most synthetics
- Ungrounded metal
- Glass

### Floors

- Any plastic (except conducting)
- Waxed surfaces
- Most carpeting

### Chairs

- Fiberglass
- Plastic (except conducting)
- Fabric covered
- Ungrounded metal
- Finished wood

### Tools

- Plastic nonconductive solder suckers

### Clothing

- Wool, silk, synthetics, furs

### Packaging Materials

- Everything nonconducting

We are all familiar with the considerable spark that can be generated as we reach for a doorknob or light switch after walking across the carpeted floor. Walking on a carpeted floor, sliding into or out

of a chair or car seat, or even brushing across the surface of a workbench or table can build up a high static potential. Even the seemingly innocent acts of combing our hair and opening the wrapper on a pack of cigarettes or candy can generate a tremendously high static potential.

To understand how this happens, you must visualize yourself as part of a capacitor. You are one plate of the capacitor, the insulating soles of your shoes are the dielectric, and the ground or floor is the other electrode. Typical human capacitance values can range from 80 to 140 pF. Because the spark generated when this "capacitor" is discharged is a function of the energy stored in the capacitor ( $CV^2/2$ ), body capacitance plays an important role when it comes to handling MOS devices. Measurements have revealed that the electrostatic po-

tential can reach between 2000 and 4000 volts.

Note clothing, floor coverings, and furniture are not the only static-electricity generators. So are many of the usual materials used in packaging and transporting static-sensitive semiconductors and, in many cases, fully populated printed circuit board assemblies.

You can demonstrate the generation of a high static potential generator by using a simple desk tape dispenser and an NE-2 neon lamp. Hold the lamp close to the tape as you rapidly peel about 18" (45.7 cm) of tape from the roll. In dim lighting, you will note that the lamp flashes as the tape rapidly peels off. Now, drop the lamp into a polyethylene bag and rub the bag against a sweater in a darkened room. Again, the lamp will flash. Peel the tape off about an inch or so above a loaded ashtray and note the results. Keep in mind that it takes about 4kV to lift the ashes one inch.

One would expect that the tools we normally use in electronics are "safe" to use on MOS devices. This is far from true. One dangerous tool to use around MOS devices is the plastic solder sucker. The sudden rapid movement of the plastic piston in the housing sleeve of the sucker can generate a very high static potential. Another tool is the soldering iron. Unless it is grounded at the tip, the iron can be a dangerous static carrier.

After looking over the list given in the table, you may be wondering if there is *anything* you can do to assure safe handling and installation of MOS devices. Rest assured that there is and that we will be dealing with this particular subject later in this article.

The destruction of a MOS device results from the rapid discharge of static electricity across the elements within the device, usually with sufficient energy to rupture the  $SiO_2$  layer. Carefully note that this is *not* the voltage to ground; it is the *potential difference* between the device's pins that does the damage. Eliminate the potential difference and you eliminate the damaging charge. Note also that no matter how high the static potential you build up by shuffling your feet on a dry carpet, you cannot "zap" one hand with the other—because there is no potential difference.

The problem with MOS devices occurs when the device's pins are placed between two points that have a high potential—usually static—difference. This is why many construction articles advise you to place one hand on the copper traces of the printed circuit board when

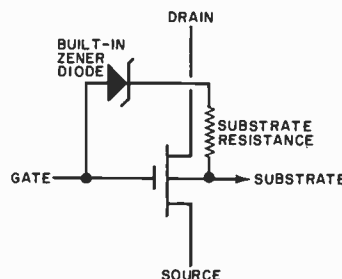

Fig. 3. The protection of a MOS device is usually 100 volts.

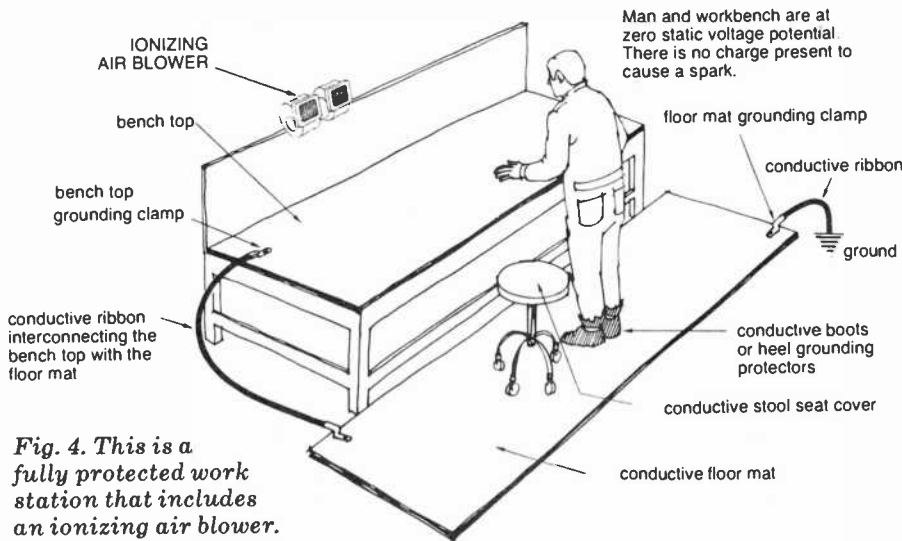

Fig. 4. This is a fully protected work station that includes an ionizing air blower. (Photo courtesy 3M Co.)

installing MOS IC's. This equalizes the potential difference. Such articles also tell you to handle the IC's only by their cases—not by their pins.

By touching the copper traces on the pc board when you install MOS devices in a circuit, you bridge conductors with a resistance that eliminates possible potential differences and discharges the human capacitor. It is even better to bridge pc board copper traces with a conductor that is better than human skin because skin resistance can be rather high in many cases.

**Avoiding the Problem.** If you plan to work with MOS devices, here are some things **YOU SHOULD NOT DO:**

- Insert MOS devices into any plastic containers or carriers unless they are of the conducting types.
- Place MOS devices or pc board assemblies on which they are installed in ordinary plastic bags.
- Hand a MOS device to another person who is not antistatic protected.
- Attempt to test a MOS device with a multimeter, even those with "low-power-ohms" functions.
- Wear nylon or other synthetic clothing. Wear clothing made from cotton or cotton blend fabrics.
- Remove jackets, sweaters, etc., near a MOS device. (Remember the experiment with the tape dispenser.)
- Handle MOS devices by their pins.

- Slide MOS devices across a surface.
- Handle Styrofoam or other plastic hot- or cold-drink cups, open cigarettes or candy packages with "cellophane" wrappers, or use plastic combs or any other item that is either plastic or wrapped in plastic.
- Use plastic solder suckers on or near the pins of MOS devices.
- One thing that most people never consider when working with MOS devices is the humidity of the working environment. The air in a very low-humidity environment is dry and has a very high resistance. Arid air will not discharge the static electricity as fast as moister air. Be particularly on your guard during the low-humidity winter months. Try to work in an environment where the relative humidity is between 30% and 50%.

Now here are some things you *should* do. MOS devices generally recommend that you wear some type of conductive wrist strap that is connected through a relatively high resistance to earth ground. This is usually followed with the instruction to similarly ground the tip of your soldering iron, tools, and test instruments that might come into contact with MOS devices both before and after they are installed in a circuit. If you heed these precautions and are working at a metal workbench or table, protect yourself from accidental shock (the protection of the MOS device is secondary here). *Never* connect your metal work station directly to ground; there should always be a minimum of 200,000 ohms between your skin and actual ground in case a faulty appliance power line or chassis has leakage to ground in excess of 0.5 mA.

Although the above precautions are one way in which you can protect your MOS devices from being zapped, it is important that you bear in mind that it is not the potential to ground that presents the hazard to the devices but the voltage *difference* that is the culprit. Therefore, all that must be done is to find some way to equalize the possible potential imbalance and thus eliminate the hazard.

Fortunately, there is another solution to the problem. This involves the use of antistatic (conductive) plastics. The RC-AS1200 conductive "pink" plastic from Richmond Division of Pak-Well and "Kimcel" from Kimberly-Clark are impregnated with a special noncorrosive organic antistatic liquid that migrates to all surfaces of the material. "Velostat" from 3M Company is a conductive plastic that has a medium resistance per square inch. Of course, we are all familiar with the black conductive plastic

## GROUNDING AND SHOCK HAZARD

Faulty electronic equipment that is not properly grounded can kill! This is the reason most modern electrically powered appliances and equipment are fitted with three-conductor power cords. One pair of conductors in the cord supplies the actual working power from the ac outlet, while the third conductor (usually color-coded green) should be connected between the metal chassis of the appliance or equipment and a good earth ground.

When installing IC's and other components in a circuit, many professionals recommend that you connect your body and the tip of your soldering iron to earth ground through a minimum resistance of 200,000 ohms. The resistor value is selected so that, in the event of an accidental short circuit, the current flow that does the actual damage is limited to 0.2 mA or less, which is considered to be a safe level. A current flow of this magnitude can barely be discerned. Listed below are the effects of

electrical current passing through the body from arm to arm. The measurements were made at 60 Hz.

Current	Effect
0 to 0.5 mA	Little or no sensation
0.5 to 1 mA	Tingling sensation
1 to 5 mA	Mild pain
5 to 10 mA	Severe pain
Over 10 mA	Muscles contract
100 mA to 2 A	Ventricular fibrillation; lethal
Over 2 A	Lethal if sustained; momentary contact produces burns and physiological shock but good chance of recovery.

The above currents and effects are for a typical human being in good health. Except for the last, all effects given are for sustained contact with the current.





## Needle in the hi-fi haystack

*Even we were astounded at how difficult it is to find an adequate other-brand replacement stylus for a Shure cartridge. We recently purchased 241 random styli that were not manufactured by Shure, but were being sold as replacements for our cartridges. Only ONE of these 241 styli could pass the same basic production line performance tests that ALL genuine Shure styli must pass. But don't simply accept what we say here. Send for the documented test results we've compiled for you in data booklet # AL548. Insist on a genuine Shure stylus so that your cartridge will retain its original performance capability—and at the same time protect your records.*

Shure Brothers Inc.  
222 Hartrey Ave., Evanston, IL 60204  
In Canada: A. C. Simmonds & Sons Limited

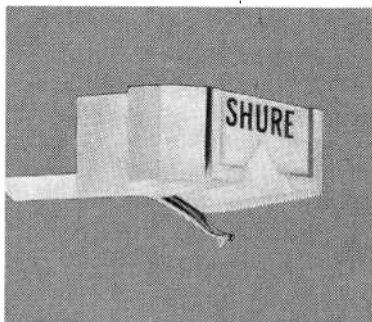

Manufacturers of high fidelity components, microphones, sound systems and related circuitry.  
CIRCLE NO. 52 ON FREE INFORMATION CARD

foam blocks used as carriers for MOS devices during shipping.

These antistatic plastics, with the exception of the last item, come in all forms—from film bags to heavy sheets to semirigid tubing. They can be used in sheet form for workbench tops, as a floor mat around the work station, and with a wrist strap and soldering-iron attachment.

The antistatic bags can be used to store static-sensitive semiconductors. You should have some distinctly labelled antistatic bags for storing semiconductors and completed MOS board assemblies.

**Protected Workbench.** A typical commercial work station that is fully protected is shown in the lead photo. Here, the technician is wearing a conductive plastic apron, is sitting on a conductive seat cover, and has her feet on a conductive floor mat. The top of the workbench is covered with a sheet of conductive plastic, and a conductive-plastic strap is attached to her bare wrist. A somewhat similarly protected work station is shown in Fig. 4. Here, the station is equipped with an optional ionizing air blower. In both cases, the entire work area, including the technicians, are at the same potential. And since there are no voltage differences, there can be no damaging static discharges that can destroy MOS devices.

If you wish to protect your work station as described here, you can obtain conductive plastic by contacting your local representative of 3M Nuclear Products (3M Center, St. Paul, MN 55101); Richmond Division of Pak-Well (P.O. Box 1129, Redlands, CA 92373); or Kimberly-Clark Corp. (Interior Packaging Dept., Neenah, WI 54956). As an aid to POPULAR ELECTRONICS readers, a hobby workbench setup consisting of a 20" x 12" (50 x 30 cm) Velostat working surface, wrist band with connecting strap, and an assortment of antistatic storage bags (including some large enough to accommodate large hobby-type computer boards) is available for \$14.95 from Associated Electronics, 1885 W. Commonwealth, Unit G, Fullerton, CA 92663.

**In Conclusion.** Though MOS devices are very sensitive to destructive discharges, you can take positive steps to greatly reduce or completely eliminate the problem at its source. By thoroughly protecting your workstation against static hazards, you can work in complete safety with any MOS device. ◇

# no strings attached

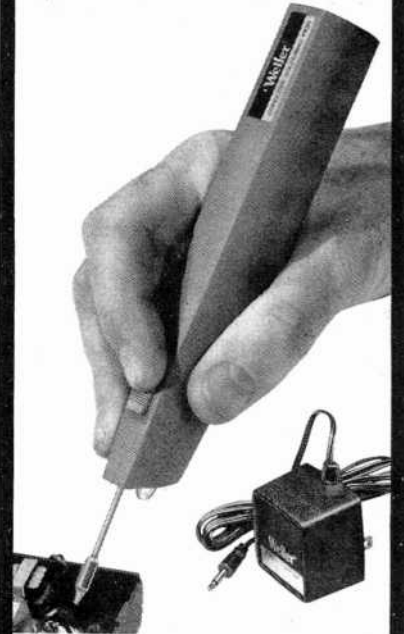

## NEW Weller® CORDLESS SOLDERING IRON... GOES ANYWHERE

Weller's WC-100 . . . the professional quality, feather-light cordless. Lets you make connections anywhere. Without AC cord and outlet.

Fingertip touch on exclusive sliding safety switch activates long-life, nickel-cadmium battery. Heats tip to over 700°F in 6 sec. Locks in "off" position to prevent accidental discharge in use or while restoring energy with fast-power recharger (UL listed).

Simple, instant change to any of 4 tips . . . for any job. Built-in light focuses on tip and work area.

Get this! It's at your dealer or distributor now . . . waiting for you. Need more info first? Request literature.

## Weller-Xcelite Electronics Division



The Cooper Group

P. O. BOX 728,  
APEX, NORTH CAROLINA 27502  
CIRCLE NO. 60 ON FREE INFORMATION CARD  
POPULAR ELECTRONICS

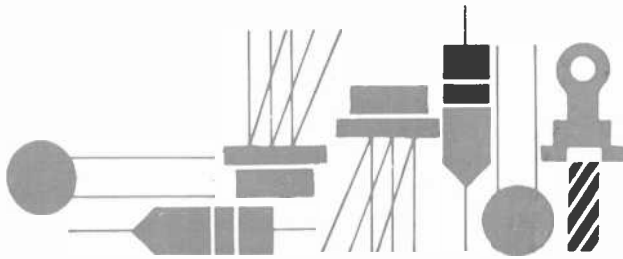

# Solid State

BY LOU GARNER

## A CIRCUIT MEDLEY

**R**ICH rewards await the circuit prospector who does his digging in the literature published by various semiconductor manufacturers. Experimenters, hobbyists, teachers, students, practical engineers and professional technicians can all find a wealth of useful circuit information in such publications.

Suggested circuits are frequently included in new device data sheets. Some are offered in separately released application notes and bulletins, and still more will be discovered in manufacturers' bimonthly and quarterly periodicals. Sometimes, the seeker will find the precise circuit needed to solve a particular problem and to complete a pet project. In other cases, he may find that a suggested design can be adapted quite easily to current needs. Just as often, he may find that a proposed circuit sparks his imagination and suggests a number of completely new projects. An instrumentation op amp, for example, may be just the ticket for a control interface. A basic temperature sensing system may be ideal for adaptation as a fire alarm, or a wideband oscillator might be just the circuit needed to complete the design for a new electronic musical instrument.

Representative circuits abstracted from semiconductor manufacturers' publications are illustrated in Figures 1 through 5. Running the gamut from an unusual automotive application to a relatively sophisticated test instrument, the designs utilize both integrated circuits and discrete devices. In general, they are not overly critical as far as either layout or lead dress are concerned, although, of course, good wiring practice should be followed.

A potential life-saver when winter once again rears its frost-covered head, the circuit illustrated in Fig. 1 is one of some ten application circuits suggested by Texas Instruments, Inc. (P.O. Box 5012, Dallas, TX 75222) in a 20-page publication

covering the firm's BIFET operational amplifiers, Bulletin CB-248. Dubbed an "Icy Road Warning Indicator," the unit is essentially a special-purpose electronic sensor designed to warn a driver when temperatures drop below a preset value. In operation, op amp *IC1A* serves as a combination voltage comparator, buffer amplifier and LED driver.

This device receives its inputs from oscillator *IC1C* and a second voltage comparator, *IC1B*, which, in turn, acts to compare the voltage applied through series combination *R1-R2* with that derived through thermistor *TDR1*. When the thermistor's temperature drops, its resistance changes, causing a corresponding change in the inverting voltage signal applied to *IC1B* and developing a control voltage which is applied to *IC1A* through isolating series resistor *R4*. With an increased voltage applied to its noninverting input, *IC1A* supplies a drive current to the LED indicator through current-limiting resistor *R10* at a rate determined by oscillator *IC1C*, causing a flashing light to warn the driver of potentially hazardous road conditions.

A single DIP quad op amp integrated circuit, type TL084, is used in the warning indicator, with three of its sections serving as *IC1A*, *IC1B* and *IC1C*. The fourth section is unused, although some clever experimenters may decide to employ it as an audio oscillator driving a small loudspeaker, thus providing an aural as well as a visual alarm. Except for potentiometer *R1* and the thermistor, all resistors are standard half-watt units, while *C1* is a conventional 15-volt electrolytic. The thermistor is rated at 15,000 ohms.

During installation, the thermistor should be positioned where it will sense outside temperatures but will not be affected by engine, exhaust, or passenger compartment heat. Naturally, the LED indicator should be placed where it will be clearly visible to the driver. After checkout and installation, *R1*

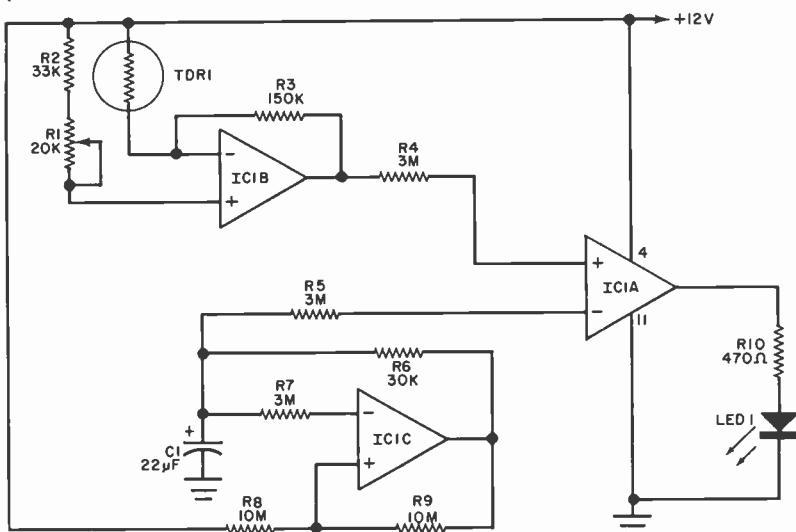

*Fig. 1. This "Icy Road Warning Indicator," suggested by Texas Instruments, is essentially a special-purpose electronic sensor using an op amp as a combination voltage comparator, buffer amplifier and LED driver.*

should be adjusted so that the LED is illuminated when the thermistor temperature drops to 32° F (0° C); during warm weather, an ice cube can be held against *TDR1* to achieve the proper temperature for the adjustment.

Featured in Volume 4, Number 2 of the bimonthly periodical *Progress*, published by the Fairchild Camera and Instrument Corporation (Semiconductor Operations, 464 Ellis St., Mountain View, CA 94042), the bidirectional intercom circuit given in Fig. 2 permits two-way "hands-free" conversations. It is ideal for use, typically, as a door answerer by a housewife busy in a kitchen or laundry as well as in commercial and industrial applications where it may not be convenient for either party to operate a *Push-to-Talk* switch. Each of the two virtually identical units making up the system features a "privacy" switch (*S1* and *S2*) in addition to individual volume (*P2* and *P5*) and tone (*P3* and *P6*) controls. The system requires a dual ±12-volt dc source, which may consist of either batteries or a well-filtered and regulated power supply.

In operation, a unique arrangement prevents intra-unit acoustic feedback. In Unit A, audio signals developed by the crystal microphone are applied to npn transistor *Q1*, which serves simultaneously as a preamplifier and phase-splitter, producing both in-phase and 180° out-of-phase signals. The in-phase and out-of-phase signals are combined in balance control *P1*, where the in-phase signal is cancelled and only a portion of the out-of-phase signal is coupled on to the next stage. At the same time, however, the amplified out-of-phase signal is applied to Unit B through the connecting link, where it is coupled through a 10-μF dc blocking capacitor, balance control *P4*, and volume control *P5* to a medium power operational amplifier. The op amp then drives a standard 16-ohm PM loud-speaker. Unit B operates in a similar fashion, with its out-of-phase signal coupled back to Unit A over the same connecting link. Thus, in-phase signals within each amplifier unit which might otherwise cause acoustic feedback are cancelled internally, and continuous two-way conversations are practical.

Standard commercial components are used in the intercom's design. Except for the balance, volume and tone control potentiometers (*P1*, *P2*, *P3*, *P4*, *P5* and *P6*), all resistors

are familiar half- or quarter-watt units. The larger capacitors are 25-volt electrolytics while the 0.005-μF capacitors used in the tone-control networks may be low-voltage ceramics, tubular paper or plastic film types. Only four active devices are used: transistors *Q1* and *Q2* (2N3695 and 2N3693, respectively) and two μA759 op amps. Privacy switches, *S1* and *S2*, are spst and may be any type. Conventional assembly and wiring techniques can be used for circuit construction. After installation, the balance controls (*P1* and *P4*) are adjusted to minimize acoustic feedback within each unit with the respective volume controls set at near maximum. Afterwards the volume and tone controls are operated as in any regular intercom system.

Intended primarily for use by photographers, the sensitive light meter circuit shown in Fig. 3 provides an analog readout proportional to the log value of light intensity and, therefore, can be calibrated directly in EV (Exposure Value) units. With ASA ratings of 100, the instrument's range is EV -3 to EV +18 on the 500-μA meter. The design is one of several for the 8007 FET-input operational amplifier described in Application Bulletin A005, published by Intersil, Inc. (10900 N. Tantau Ave., Cupertino, CA 95014). In addition to the 8007, the circuit uses a SBC 2020 silicon photodiode, an IT120 dual npn transistor, and a conventional 741 op amp. In operation, temperature compensation is provided by voltage divider *R1-R2*, which forms a gain block in conjunction with half of the dual transistor and the 741. Diode leakage errors are minimized by operating the photodiode at essentially zero voltage, while a log-gain characteristic is achieved by means of the transistor feedback element. The instrument requires a standard ±15-volt dual dc power source, with power supply connections to IC pins 7(+) and 4(-).

Featuring discrete devices and conventional IC's, the wide-range function generator in Fig. 4 offers serious experimenters more of a challenge than do simplified designs using special-purpose devices, such as the XR-2206. It is described by Robert C. Dobkin in Application Note AN-115, published by the National Semiconductor Corporation (2900 Semiconductor Drive, Santa Clara, CA 95051). The instrument is capable of supplying sine, square and triangular waveforms at ampli-

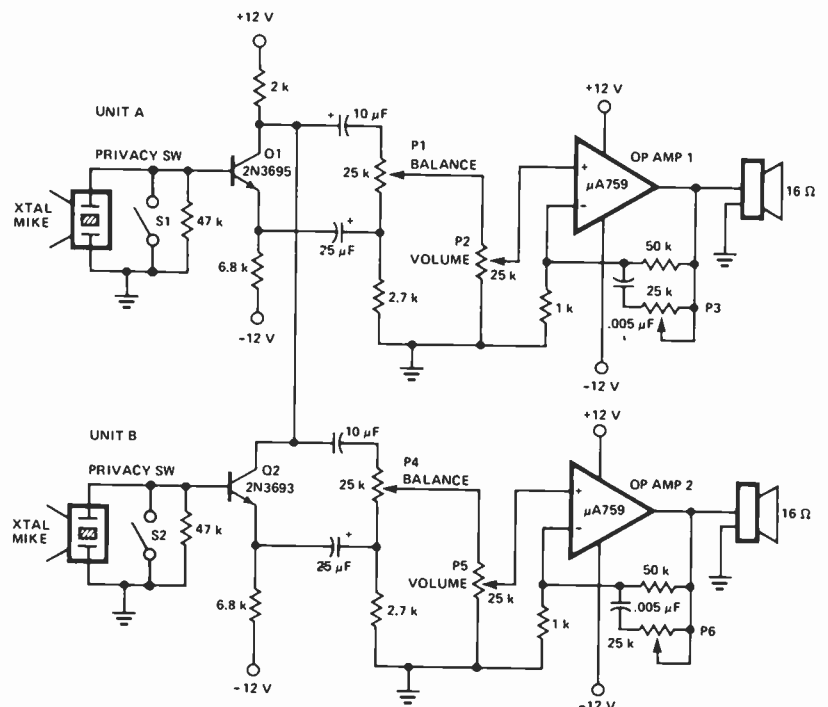

Fig. 2. Fairchild's bidirectional intercom system permits two-way "hands-free" conversations. Each of the two units has a privacy switch in addition to individual volume and tone controls.

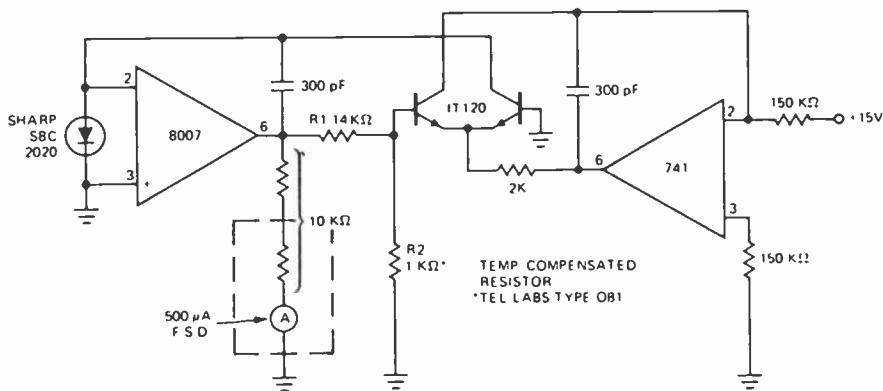

Fig.3. From a bulletin published by Intersil, this light meter circuit for photographers provides an analog readout proportional to the log value of light intensity. It uses an 8007 FET-input op amp.

tudes up to  $\pm 10$  V from 10 Hz to 1 MHz without band switching. Usable outputs are available to as high as 2 MHz, but of reduced amplitude and waveform quality. It requires three IC's, a dual pnp transistor, two dual npn transistors, two conventional npn transistors, and seven standard diodes. With both trigger and signal outputs, the instrument has two semi-fixed adjustments and three operating controls in addition to its power switch: a three-position FUNCTION switch, a FREQUENCY control, and an AMPLITUDE control.

The basic generator comprises an LM319 dual voltage comparator, current-source switching transistors Q1-Q2 and Q3-Q4, timing capacitor C1, and an LH-0033C FET-input voltage follower buffer amplifier. A triangular signal waveform is generated by alternately charging and discharging timing capacitor C1 through switching current-source transistors Q1-Q2 and Q3-Q4 and diodes D1 and D2. The resulting signal is

amplified by the LH0033C voltage follower and coupled back through voltage-divider R8-R9-R10 as inputs to the LM319 dual voltage comparator which forms part of the feedback network. The triangular signal also is applied to function switch S1 through series isolating resistor R18. Control dc voltages obtained from voltage-dividers R20-R32 and R23-R31 set the threshold at the other inputs of the voltage comparators, thus establishing the peak-to-peak amplitudes of the comparator outputs. Connected in parallel, the comparator output signals are applied to emitter follower Q5, which serves both to supply a square-wave output signal to function switch S1 through series isolating resistor R24 and to provide a drive signal to the current-source switching transistors, Q1-Q2 and Q3-Q4.

The generator's frequency of operation depends on C1's charge and discharge currents. Ranging from 5 nA to 5 mA, these are controlled by the emitter bias applied to the switch-

# NOW YOU CAN BUILD A COMPLETE MOTOROLA M6800 MICRO-PROCESSOR FOR ONLY \$235

If you've wanted to learn about Microprocessors — How to build them — How to program them — How to use them — Here's your chance to start from the ground up. This Motorola MEK6800D2 Kit has all the parts necessary to complete the system and get "on-the-air," except for the Power Supply.

### This is the popular "Kit-in-the-Book" that includes:

- 1 - MC6800 MPU
  - 2 - MCM6810 RAMs
  - 2 - MC6820L PIAs
  - 1 - MC6830L - ROM
  - 1 - 24-KEY KEYBOARD
  - 1 - MC6850L - ACIA
  - 2 - PC BOARDS
  - 1 - MC6871 CLOCK
  - 1 - 6-DIGIT DISPLAY
  - 1 - SOCKET FOR 68708 EROM
- and complete kit of resistors, capacitors, sockets, circuits, etc.

The step-by-step Instruction/Construction manual, the Programming Reference Manual and the other literature makes it possible for anyone with a reasonable ability to use a soldering iron, to assemble this two-board kit into a working Microprocessor in 5 or 6 hours . . . and then the fun begins. You can learn to program and see the expandability potential of this powerful Microprocessor. It's all "in the book."



**MOTOROLA MPU KIT SALES**  
P.O. Box 27605 — Tempe, AZ 85282

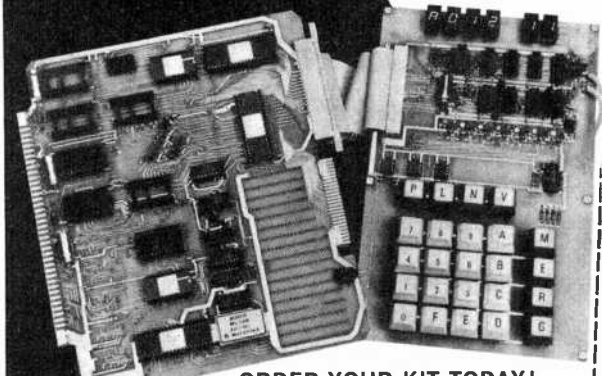

ORDER YOUR KIT TODAY!

— Please send more information about the MEK6800D2 Microprocessor Kit

— Enclosed find my check or money order for \$235. Send my kit as quickly as possible. (Add \$5.00 shipping and handling plus applicable state and local tax)

— Charge this to my: Master Charge No. \_\_\_\_\_ Exp. Date \_\_\_\_\_

BankAmericard No. \_\_\_\_\_ Exp. Date \_\_\_\_\_

(Signature necessary to authorize bank card charges)

NAME: \_\_\_\_\_ (please print)

ADDRESS: \_\_\_\_\_

CITY & STATE: \_\_\_\_\_ ZIP: \_\_\_\_\_



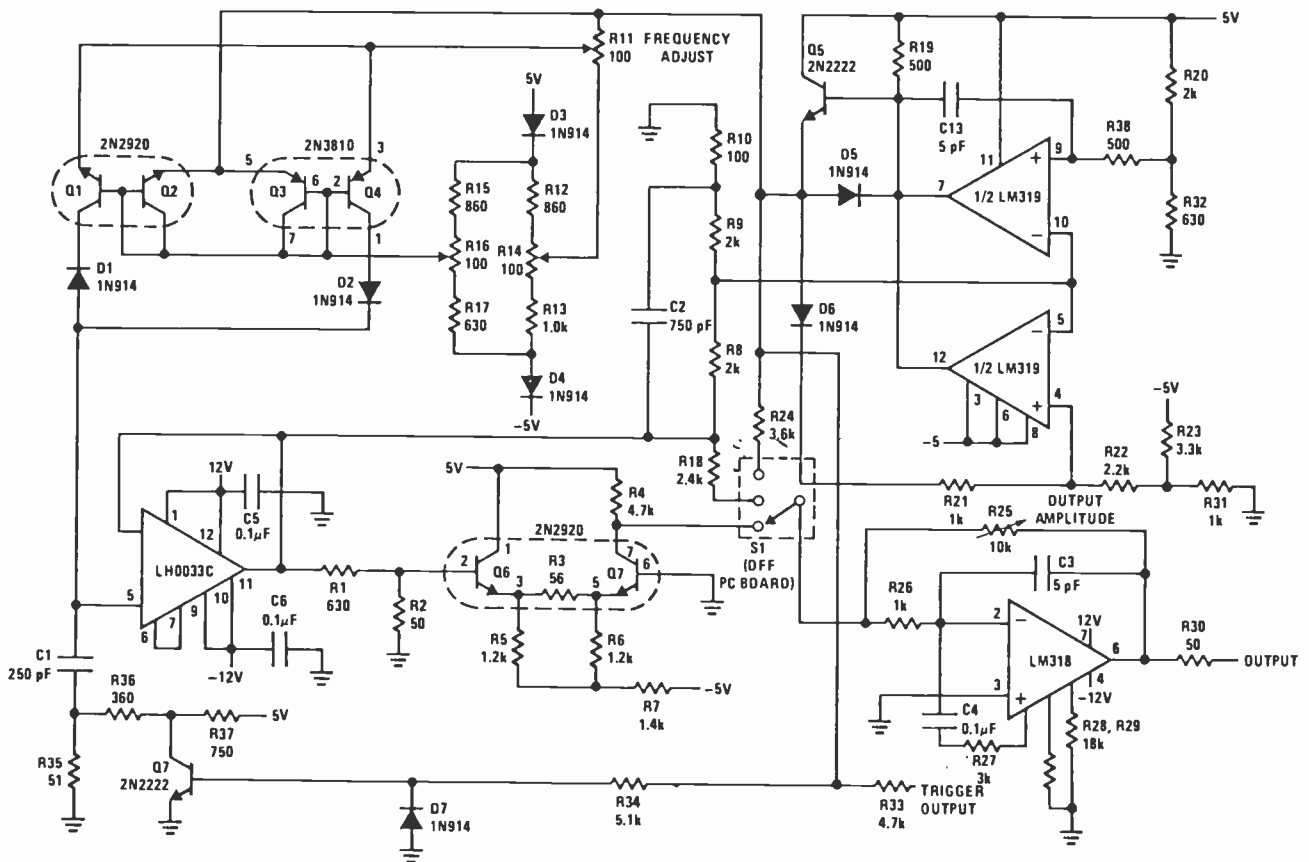

Fig. 4. National Semiconductor's wide-range function generator circuit.

## Treat yourself to a new direct reading DVM today.



### DVM35

POCKET PORTABLE  
ANALOG REPLACEMENT  
3-digit, 1% DCV  
Battery or AC  
Only \$134



### DVM36

LAB ACCURATE  
POCKET PORTABLE  
3½ digit, .5% DCV  
Battery or AC  
Only \$158



### DVM32

BENCH & FIELD MASTER  
3½ digit, .5% DCV  
Battery or AC  
Only \$198



### DVM38

"PRIME" STANDARD AT  
YOUR FINGERTIPS  
3½ digit, .1% DCV  
Auto-Ranging  
Only \$348

## A COMPLETE LINE OF DVMs TO FILL YOUR EVERY NEED OR WANT.

You can be sure more times in more circuits, under more adverse conditions, with greater versatility, accuracy, and meter protection than any other digital multimeters on the market today; and for less money, too. 10 Day Free Trial: Try any of these famous DVMs for 10 days. If the DVMs in use don't prove exactly what we say, return them to your Sencore FLPD Distributor.

Want more information? We would like to tell you all about the Sencore DVMs by sending you a 24-page Sencore News, a six-page brochure, and the name of your nearest Sencore Distributor today... simply write or circle reader's service number.

3200 Sencore Drive, Sioux Falls, SD 57107

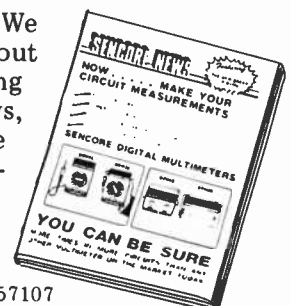

# SENCORE

CIRCLE NO. 51 ON FREE INFORMATION CARD

ing transistors through frequency control R11. Differential amplifier Q6-Q7, operated with degenerative emitter feedback, serves to modify the triangular signal delivered by the buffer amplifier through voltage-divider R1-R2. This develops a close approximation to a sine wave across output load R4 which is applied directly to function switch S1. From S1, the selected signal waveform is coupled through series resistor R26 to the LM318 serving as the output amplifier. The output amplitude is controlled by R25, which provides inverse feedback across the op amp.

The function generator requires regulated dual  $\pm 5$ - and  $\pm 12$ -volt dc sources for proper operation. Suggested by National Semiconductor in its Application Note, the ac line operated power supply in Fig. 5 will provide the correct voltages. A conventional design, it comprises a spst ON-OFF switch, fuse, 24-volt step-down transformer, bridge rectifier, two filter capacitors (C7 and C8), positive and negative 5- and 12-volt regulator IC's, and four bypass capacitors (C9, C10, C11 and C12). All of the regulators are standard 3-terminal devices.

Though standard parts are specified in the instrument's design, some care must be exercised in the choice of components to insure optimum performance. A standard potentiometer may be used for frequency control R11, for example, but a vernier type or 10-turn pot is preferred due to the unit's six-decade frequency coverage. The output level control, R25, can be a standard potentiometer, with trimmer types used for semi-fixed adjustments R14 and R16. All fixed resistors may be either quarter- or half-watt types, but should have a 5% tolerance rating except for R1, R2, R5, R6 and R7, which should

## MAKE GREAT CONNECTIONS!

### IC SOCKETS

3 Level Wire Wrap Gold

	1-9	10-24	25-100
14pin	.38	.37	.36
16pin	.42	.41	.40
18pin	.73	.65	.59
24pin	1.00	.91	.83
40pin	1.69	1.51	1.37

Low Profile D.I.P. Solder-tall. (TIN)

	1-9	10-24	25-100
8 pin	.15	.15	.14
14pin	.18	.17	.16
16pin	.20	.19	.18
18pin	.27	.26	.25
20pin	.29	.28	.27
22pin	.35	.34	.33
24pin	.36	.35	.34
28pin	.42	.41	.40
40pin	.60	.57	.53

### SINGLE END

	6"	12"	18"	24"	36"	48"
14 pin	1.31	1.62	1.72	1.83	2.05	2.26
16 pin	1.64	1.76	1.87	1.99	2.21	2.44
24 pin	2.49	2.69	2.88	3.08	3.48	3.87

### DOUBLE END

	6"	12"	18"	24"	36"	48"
14 pin	2.76	2.87	2.97	3.08	3.30	3.51
16 pin	3.01	3.13	3.24	3.36	3.58	3.81
24 pin	4.55	4.75	4.94	5.14	5.54	5.93

**MORE for your money!**

### DUAL IN-LINE PLUGS



### PLUGS COVERS

	1-24	25-49	1-24	25-99
8 pin	.46	.46	.39	.10
14 pin	.48	.40	.10	.09
16 pin	.56	.47	.10	.09
24 pin	.79	.72	.15	.13
40 pin	\$1.23	\$1.08	.25	.22

### PRE-STRIPPED WIRE-WRAPPING WIRE

\* CUT TO LENGTH \* BOTH ENDS STRIPPED \*

L	Price per Tube of 100	Price per bag of 1,000
1=	\$1.48 (WW30VC-1)	\$13.84 (WW308K-1)
2=	\$1.60 (WW30VC-2)	\$12.30 (WW308K-2)
4=	\$1.85 (WW30VC-4)	\$14.80 (WW308K-4)
6=	\$2.20 (WW30VC-6)	\$17.60 (WW308K-6)

### YES! WE HAVE ok WIRE-WRAPPING TOOLS

#### Hobby-Wrap-30 & 30M



Wire-wrapping, stripping, unwrapping tool for AWG 30 on Q25 (0.63mm) Square Post

Regular Wrap	WSU 30	\$5.95
Modified Wrap	WSU 30M	\$6.95

#### NEW Battery powered wire-wrapping tool

**\$34.95**

Only \$34.95 Batteries not included. Replacement Bit BT-30... \$2.95

**FREE!** Free 50' wire with either tool

## TRI-tek, inc.

6522 R NORTH 43RD AVENUE.  
GLENDALE, ARIZONA 85301

SEND FOR FREE CATALOG  
CIRCLE NO. 57 ON FREE INFORMATION CARD



## Announcing the NEW STANDARD in Stereo Testing!

# The All-New Model SR12 STEREO TEST RECORD

## The most complete...most sophisticated... most versatile Test Disc available today... For Just \$6.95!

Whether you're an avid audiophile, a casual listener or a professional technician... the new MODEL SR12 will be the most important disc in your entire collection.

MODEL SR12 has been produced by Stereo Review Magazine for music lovers who want immediate answers to questions about the performance of their stereo systems and how to get the best possible sound reproduction.

It is the most complete test record of its kind — containing the widest range of checks ever included on one test disc.

### Make these important stereo checks BY EAR... (no test instruments required)

- ▶ Frequency response—a direct warble-tone check of nineteen sections of the frequency spectrum, from 20 to 20,840 Hz, which will pinpoint any frequency response defects in your system.
- ▶ Separation—an ingenious test which indicates whether you have adequate separation for good stereo.
- ▶ Cartridge tracking—the most sophisticated tests ever devised for checking the performance of your cartridge, stylus and tone arm.
- ▶ Channel balance—two broad-band, random-noise signals which permit you to eliminate any imbalances originating in cartridge, amplifier, speakers or room acoustics.
- ▶ Hum and rumble—foolproof tests that help you evaluate the actual audible levels of rumble and hum in your system.
- ▶ Flutter—a sensitive "musical" test to check whether your turntable's flutter is low, moderate, or high.

**PLUS!** • Cartridge and Speaker Phasing • Anti-Skating Adjustment • "Gun Shot Test" for Stereo Spread • Multi-purpose Musician's "A" • Equal-tempered Chromatic Octave • Guitar-tuning Tones.

Attention Professionals . . . . . Model SR12 is also designed to be used as a highly efficient design and measurement tool. Tests below have been controlled to laboratory tolerances—affording accurate numerical evaluation when used with oscilloscope, chart recorder, output meter, intermodulation-distortion meter and flutter meter.

- 1,000-Hz square waves to test transient and high-frequency response of phono pickups.
- 500 to 20,000 Hz frequency-response sweep.
- Sine-wave tone-bursts to test transient response of pickup.
- Intermodulation test using simultaneous 400-Hz and 4,000-Hz signals.
- Intermodulation sweep to show distortion caused by excessive resonances in tone arm and cartridge.
- 1,000-Hz reference tones to determine groove velocity.
- 3,000-Hz tone for flutter and speed tests.

Sample waveforms—illustrating both accurate and faulty responses are provided in the Instruction Manual for comparison with the patterns appearing on your own oscilloscope screen.

**FREE**—An informative manual which includes charts, tables and diagrams.

CHARGE YOUR ORDER TO YOUR AMERICAN EXPRESS, BANKAMERICARD, MASTER CHARGE OR DINERS CLUB ACCOUNT.

Ziff-Davis Service Division, Dept. R, 595 Broadway, N.Y., N.Y. 10012.

Please send the SR12 Stereo Test Record @ \$6.95, postpaid (\$8.95 outside U.S.A.).

Enclosed is \$\_\_\_\_\_ (Residents of Calif., Col., Fla., Ill., Mich., Mo., N.Y. State, D.C. and Tex. add applicable sales tax.)

CHARGE:  BankAmericard  Master Charge  American Express  Diners Club PE8-77

Account # \_\_\_\_\_ Exp. Date \_\_\_\_\_  
Master Charge Interbank # \_\_\_\_\_ (4 numbers over your name)

Signature \_\_\_\_\_

Print Name \_\_\_\_\_

Address \_\_\_\_\_

City \_\_\_\_\_ State \_\_\_\_\_ Zip \_\_\_\_\_

carry a 1% tolerance. Good quality ceramic or plastic film capacitors should be used in the generator circuit, 25-volt electrolytics as power supply filters *C7* and *C8*, and solid tantalum types for the power supply bypass units (*C9*, *C10*, *C11* and *C12*). Function switch *S1* is a 3-position, single-pole, non-shorting rotary switch.

If a separate power supply is used, bypass capacitors *C9* through *C12* should be wired within the function generator. However, with careful planning the entire circuit, including the

power supply (except for the power transformer and ac line components), can be assembled on a single pc board. A common heat sink should be used to couple switching transistors *Q1-Q2* and *Q3-Q4* to insure thermal tracking. After assembly and check-out, two simple adjustments are required. With the function switch in mid-position (triangular wave output), *R11* is set for a 1-MHz signal and *R16* is adjusted for perfect waveform symmetry. Next, *R11* is set for a 10-Hz output and *R14* is adjusted for perfect symmetry.  $\diamond$

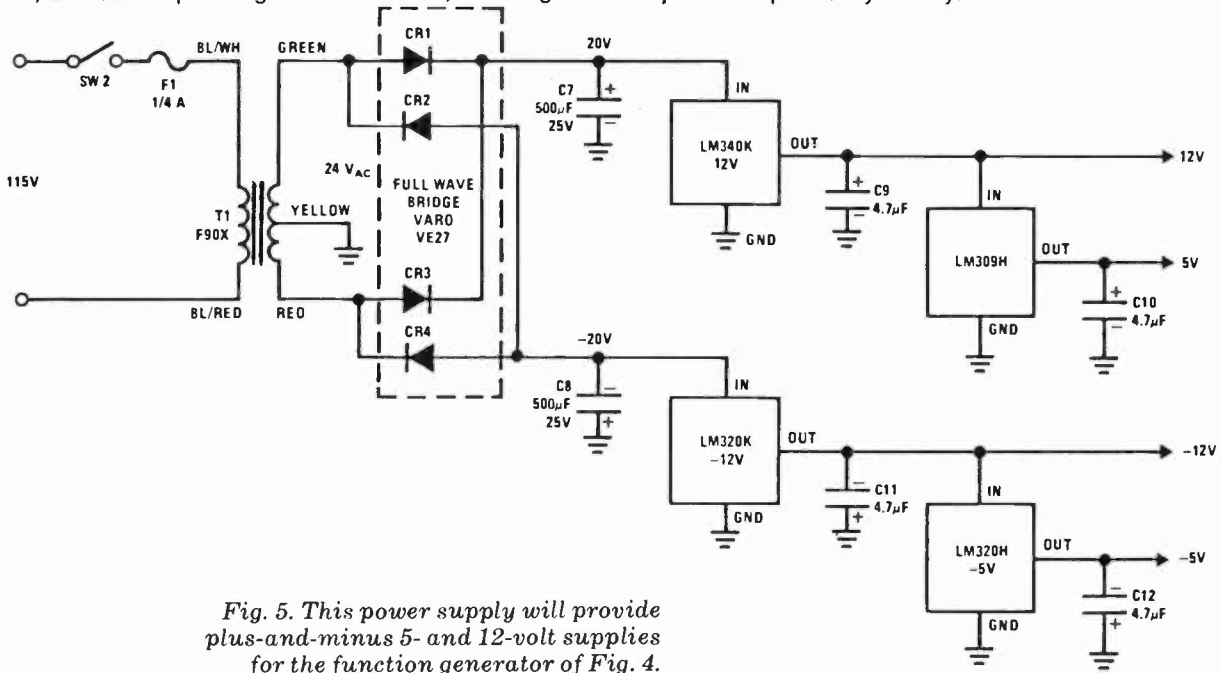

Fig. 5. This power supply will provide plus-and-minus 5- and 12-volt supplies for the function generator of Fig. 4.

## STAY TURNED ON with your low power FRIENDS FROM CIS

**Autoranging DMM**     \$ 99.95  
**Frequency Counter**   \$119.95  
**Logic Probe**         \$ 34.95

Liquid crystal displays, plus CMOS designed testers offer you long life from a single 9 volt battery.

**AUTORANGER™ DMM.** Fast responding 3.5 digit liquid crystal display with full automatic operation. Autoranging up to 1000 volts and 2000 K $\Omega$ . Automatic zeroing. Automatic polarity sensing. Protected to 600 vdc. 10 Meg Input. Resolution 1 mv. Accuracy DCV 0.5% reading + 1 digit. **All for \$99.95.**

**30 MHz FREQUENCY COUNTER.** Liquid crystal 6 digit display allows 8 digit Resolution when switching the range to an overflow condition. 200 mv rms sensitivity and input of 10 K $\Omega$  minimum. RCA phono connection. **\$119.95.**

**PROBIT™ LOGIC PROBE.** Tests TTL/CMOS pulses-down to 35 NS and frequencies up to 40 MHz. Uses 7 segment LED display — "H", "L", "dot" for pulses. Flexible, detachable tip plus "Micro-Hooks" for power. Includes pocket carrying case. **\$34.95.**

**FREE 15 DAY TRIAL.** Be convinced or get your money back. Full 90 day warranty. Each tester shipped complete with battery, schematic, assembly drawing, parts lists.

For More Convenience, Call Now With Your Order  
TOLL FREE: 1-800-527-4634  
(Texas Residents 1-214-234-4173)

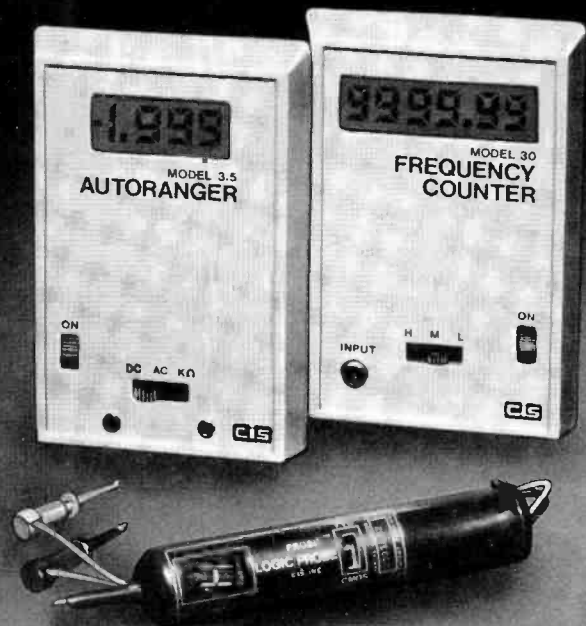

Yes. Send \_\_\_\_\_ DMM Autoranger \* @ \$99.95  
Send \_\_\_\_\_ Frequency Counters @ \$119.95  
Include \_\_\_\_\_ DMM/FC Carry Cases @ \$3.95  
Send \_\_\_\_\_ Logic Probes @ \$34.95  
Add Shipping \$2.00 each  
(Texas Residents add 5% sales tax)

Control & Information  
Systems, Inc.  
10 Spring Valley Village  
Richardson, Texas 75080

\_\_\_\_ M/C    BAC    #  
Check or MO enclosed.

Name \_\_\_\_\_  
Street \_\_\_\_\_  
City \_\_\_\_\_  
State \_\_\_\_\_



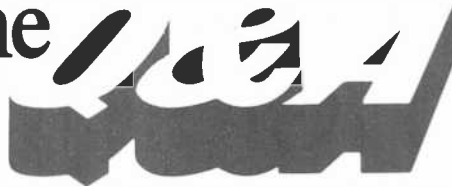

By John McVeigh

## VOX POPULI

**Q.** Could you please explain how a voice-operated switch in an SSB transmitter works?—R. Lloyd, Goldsboro, NC.

**Q.** Can you suggest a circuit for a VOX switch for use with my transmitter?—Dan Brown, New Albany, IN.

**A.** A VOX circuit samples the microphone signal, usually after amplification by a mike preamp. The signal is further amplified by a VOX amp, then rectified and smoothed into a positive dc level by an RC filter with a fairly long time constant. The receiver's audio output is also sampled, conditioned by an anti-VOX amp, then rectified and filtered by a diode and RC filter into a negative dc level. The VOX and anti-VOX signals are summed and applied to a comparator.

When the operator is not speaking, the microphone picks up the audio. But the anti-VOX signal prevents the receiver audio from tripping the VOX circuit. When the microphone detects speech, a positive input is applied to the compara-

tor. When the VOX input exceeds a reference voltage (applied to the comparator to limit VOX sensitivity), a relay driver such as a transistor conducts, energizing the VOX relay. This relay in turn activates the transmitter's T/R relay. Also included in most VOX circuits is a delay circuit. This holds the VOX relay closed for an adjustable interval of time, thus preventing relay drop-out and chatter between syllables and closely spaced words.

A really nifty VOX circuit appeared in an article called, "A VOX for a Very Small Box," in *QST* for March 1976. It uses just two IC's and is powered by +12 volts dc. Back issues of *QST* are available for \$1.50 from the American Radio Relay League, 225 Main Street, Newington, CT 06111.

## ANTENNA DESIGNS

**Q.** I own a Bearcat IV scanner and would rather make an antenna than buy one. Can you show me a few simple and effective designs for external

ground. If there is a potential difference between the two chassis, a current can flow around the ground loop. This can lead to hum problems. The easiest way to open the loop is to remove the grounding strap at either component A or component B. The chassis will still be grounded through the braid of the shielded lead—but only at one point.

It doesn't really make a difference which way you wind the coils for a line filter. Just be sure that wire with adequate insulation and capacitors rated for line bypassing (such as 1000-volt ac disc ceramic types) are used. Observe good construction practices and keep safety in mind. When in doubt, use a commercial UL-approved line filter.

## GROUND LOOPS

**Q.** I would like to know how to avoid ground loops. Also, should the coils in a power line filter both be wound in one direction, or one clockwise and the other one counterclockwise?—Charles Gulino, Brooklyn, N.Y.

**A.** The fundamental rule for avoiding ground loops is to make sure that only one grounded lead is connected to the chassis of a particular component. The figure shows an example of a ground loop. Note that the shielded cable between component A (say, a preamp) and component B (a power amp) is tied to both chassis. Also, separate grounding straps are run from each chassis to

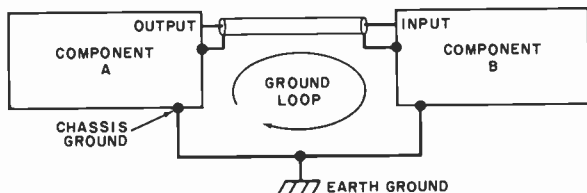

scanner antennas which will work in the low and high vhf bands?—Chris Del Plato, Whippany, NJ.

**A.** There are many things to be considered here. You'll have to decide whether you want one antenna for each band, or say a broadbanded antenna to cover more than one. Also, are you interested in a low-gain, omni-directional antenna or a high-gain directional one? It's best to consult one of the many books on the subject, such as *The Radio Amateur's Handbook*, *The ARRL Antenna Book*, *The Radio Amateur's VHF Manual* (published by the American Radio Relay League, 225 Main Street, Newington, CT 06111), or the *VHF Handbook for Radio Amateurs* (Radio Publications, Box 149, Wilton, CT 06897), or the *Radio Handbook* (Editors and Engineers Division, Howard W. Sams & Co., Indianapolis, IN 46268).

Have a problem or question on circuitry, components, parts availability, etc? Send it to the Hobby Scene Editor, POPULAR ELECTRONICS, One Park Ave., New York, N.Y. 10016. Though all letters can't be answered individually, those with wide interest will be published.

## THE PAIA 8700 COMPUTER/CONTROLLER

An exceptional price on an applications oriented 6503 based micro-processor system



THE IDEAL, LOW COST SOLUTION TO IMPLEMENTING THOSE WILD COMPUTER BASED CONTROL SYSTEMS YOU'VE BEEN DREAMING OF!

PAIA software currently available or under development includes: Music synthesizer interface; Home applications package including: multi-zone fire/burglar alarm, real time clock, energy saving heat/air conditioning control, computer generated "door-bell"; Model railroad controller and more. ....

8700 COMPUTER/CONTROLLER KIT \$149.95 (requires 5v. @ 1.2A.; 12v. @ 150 ma.)

Shipped direct from PAIA (add \$3.00 postage)

Also available at FULL LINE computer stores

DETAILS IN OUR FREE CATALOG

PAIA • DEPT. 8-P • 1020 W. Wilshire Blvd. • Oklahoma City, OK 73116



# There's an electronic kit that's exciting **NEW HEATHKIT® CATALOG.**

Here are just a few of the things **YOU** can build!

## New **VALUE-PRICED ECONOMY STEREO RECEIVER**



The new AR-1219 AM/FM stereo receiver is just the one to have for "budget" priced stereo systems, smaller listening rooms, apartments, dorms, etc. It has good power (15 watts, minimum RMS, per channel into 8 ohms with less than 0.1% total harmonic distortion from 20-20,000 Hz); a sensitive FM-AM tuner with a PLL multiplex circuit and a factory-assembled and aligned FM front end; inputs for phono and tape, a tape monitor, and built-in AM and FM antennas. Plus tasteful styling to complement any decor.

## New **SPEAKER SYSTEMS**

A complete line of full-fidelity speaker systems for any budget or listening need. Everything from compact bookshelf models to full-size floor models like the exciting new AS-1348 — great sound and great kit savings!



## New **AIRCRAFT CLOCK/TIMER**



Gives you the reliability, convenience and versatility you **WANT** for precise flight timing at substantial savings. Dual 4-digit displays—one showing 24-hour GMT or ZULU time and the other performing a function you preselect; local time, 24-minute timer, 24-hour trip timer, or a special alarm timer ideal for fuel management. The OL-1154 fits a standard 3 1/8" instrument panel for easy mounting in most any aircraft.

## New **AMATEUR RADIO NOVICE LICENSE LEARN-AT-HOME COURSE**



The Amateur Radio course so good it's **GUARANTEED**. Effective Heathkit "programmed" instruction text plus audio cassettes teach you all you need to know to get your Amateur Radio Novice License. In fact, we're so confident of this course, that if you don't obtain your License after passing it, we'll refund your money! We even include a variety of operating aids to help you set up your station.

## New **HOME PRODUCT KITS**



Heath has products to make your home a healthier and safer place. Security systems, a unique freezer alarm, lamp dimmers and electronic air cleaners, and a **TOTALLY NEW** energy and money-saving home furnace heating control that can save you 5-10% on your heating bill.



# FREE

New Heathkit Catalog describing nearly 400 superb electronic kits that you can build yourself for pride, satisfaction and **SAVINGS.**

# just right for you in this

Discover why thousands of people just like you enjoy handcrafting their own electronic equipment with exciting Heathkit products.

Building our kits is so easy and so much fun that most people enjoy the building just as much as they do using the product! There's the pride of accomplishment, the satisfaction of making something with your own two hands and the knowledge that you've "mastered" a sophisticated piece of electronic equipment. And every Heathkit product is designed for easy buildability. Our world famous step-by-step assembly manuals leave nothing to chance — they even teach you to solder properly. And every kit product we sell is backed by our "We won't let you fail" pledge. Find out about the exciting electronic products you can build. Send right now for your FREE Heathkit catalog!



## New HIGH-PERFORMANCE FREQUENCY COUNTERS

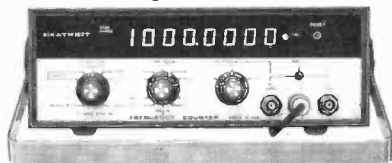

Get the frequency counting capability you NEED for accurate measurements all the way to 1 GHz! Three new counters feature big bright 8-digit LED readout, high-quality time base, input attenuation; plus period, period averaging and events counting. Choose 110 MHz, 250 MHz or 1 GHz models. Put one on your bench for real accuracy and versatility!

## New SSB/CW TRANSCEIVER



We've taken our finest Amateur Radio transceiver, improved the sensitivity and included a factory assembled and tested front end circuit board for better reliability and reduced assembly time. And kept the same low price!

## New FUN TO OWN KITS

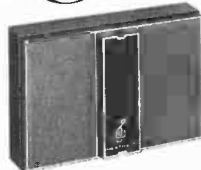

Some Heathkit products are just plain fun to own and use. An exciting TV game that lets you play hockey, tennis or handball in full color, a unique programmable door bell that announces visitors with your favorite tune. A programmable digital stopwatch that times just



about anything with 1/100th second precision, treasure finder/metal locators for beach-time fun, marine electronics, and lots more. There's a complete line of digital electronic clocks and weather instruments including the popular digital floor and shelf clocks. There's also a convenient mount-anywhere touch-control light switch.



## New COMPUTERIZED TV KIT



The first and only Programmable Computerized Color TV System: The GR-2001. Its optional programming panel lets you preselect an entire evening's viewing, then just relax as the GR-2001 changes channels automatically at the proper time. You can even program it to rotate your outdoor antenna system automatically. A real breakthrough in TV convenience.

## Coming This Fall! The Exciting NEW HEATHKIT Personal Computer Systems

See them at PC-77 Personal Computing Consumer Trade Fair, Atlantic City, August 27 and 28.

## Send for your FREE copy today!

Return card or coupon for your FREE Heathkit catalog today. It has complete descriptions and photos of some of the most exciting electronic products you can find anywhere, all in easy-to-build, money-saving kit form. Plus low discount prices on fully-assembled Johnson, Royce and Midland CB radios.

Heath Company, Dept. 010-320  
Benton Harbor, Michigan 49022

HEATH  
Schlumberger

Heath Company, Dept. 010-320  
Benton Harbor, Michigan 49022

Please send me my FREE Heathkit Catalog.  
I am not on your mailing list.

Name \_\_\_\_\_

Address \_\_\_\_\_

City \_\_\_\_\_ State \_\_\_\_\_

GX-332 \_\_\_\_\_ Zip \_\_\_\_\_

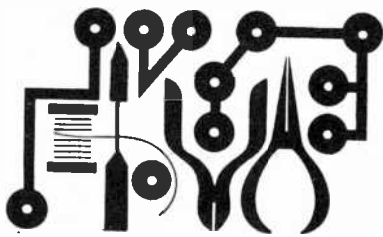

# Experimenter's Corner

By Forrest M. Mims

## THE FOUR-LAYER DIODE

**T**HE FOUR-LAYER diode is a pnpn negative-resistance, two-terminal device with switching properties similar to those of the neon glow lamp (see December 1976 "Experimenter's Corner"). Below a certain voltage level, variously called the trigger, threshold, avalanche or firing voltage, the diode has a very high electrical resistance and is said to be in the "off" state. When the applied voltage reaches the trigger level, the re-

sistance of the diode abruptly drops to a few ohms or less and the diode enters the "on" state.

Sometimes called the Shockley diode after its inventor, the four-layer diode is virtually unknown to most electronics experimenters. Many of them, however, have used a four-layer diode with a third electrode, the well-known SCR (silicon controlled rectifier). While the four-layer diode will only trigger at a specific firing voltage, the SCR can be made to switch over a wide voltage range by simply applying a trigger pulse to its gate electrode. And, as some experimenters have accidentally learned, the SCR will self-trigger just like a four-layer diode if the anode-cathode voltage exceeds a certain "forward breakdown voltage."

It's true that the gate terminal makes the SCR a more versatile electronic switch than the basic four-layer diode. Nevertheless, since the four-layer diode

is capable of self-switching, it is ideal for use in ultra-simple relaxation oscillator circuits. Considerable operating flexibility is available since four-layer diodes are available with trigger voltages ranging from 10 to more than 100 volts.

Finally, we know that since *D1* has a

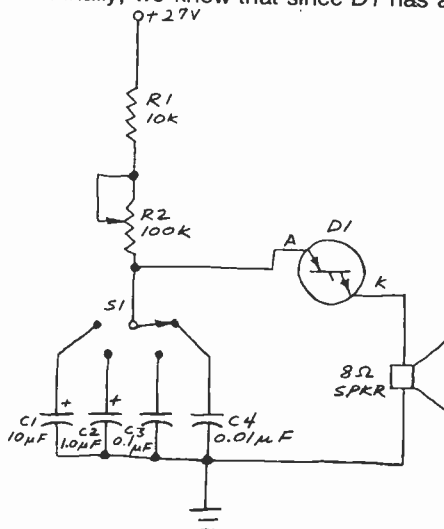

Fig. 2. Audio oscillator.

very low "on" resistance, very high currents can be present during the circuit's discharge cycle. For example, if both  $R_L$  and  $D1$  (in the "on" state) each have a resistance of one ohm, the total resistance across  $C1$  is only two ohms. Ohm's law says the current in a circuit equals the voltage divided by the resistance ( $I = E/R$ ). Therefore, if  $D1$  fires at 50 volts, an impressive 25 amperes will flow through  $D1$  and  $R_L$  during the discharge cycle of  $C1$ !

Of course, 25 amperes will rapidly destroy a relatively puny four-layer diode if applied continuously. But by limiting  $C1$  to about  $0.1 \mu F$  the width of the current pulse will be a very brief microsecond or so. This keeps unwanted heat build-up to a minimum and protects the diode from thermal destruction.

The ultra-fast switching speeds of the four-layer diode (less than 50 nanoseconds) mean that the inductance of the wire leads in the discharge path can slow the discharge pulse and induce ringing (negative undershoot). This isn't serious in some applications, but it can cause problems in others.

**Practical Circuits.** The super-simple circuitry of a four-layer diode relaxation oscillator lends itself to many practical applications. For example, Fig. 2 shows a simple, yet versatile, audio oscillator which can be used to produce audio frequencies ranging from the "pock . . . pock . . . pock" of a metronome to the ear-piercing sound of a 10,000-Hz tone. Switch  $S1$  permits various values of capacitance to be selected. Potentiometer  $R2$  varies the frequency of the circuit by altering the charging rate of the discharge capacitor. Diode  $D1$  can be any common four-layer diode such as the 1N3831 through 1N3846, the 4E series or the M4L series.

Diodes with low firing voltages work well and simplify firing requirements. (See the specs for individual diodes.) For example, power for a diode with a 20-volt firing voltage such as the 1N3821 can be supplied by a series string of three fresh 9-volt transistor radio batteries.

The circuit in Fig. 2 can easily be adapted for use as a pulse generator by substituting the simple network in Fig. 3

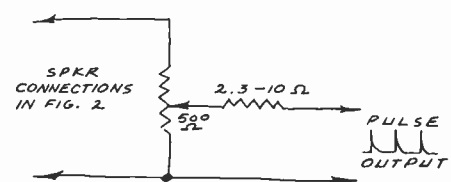

Fig. 3. Pulse generator output.

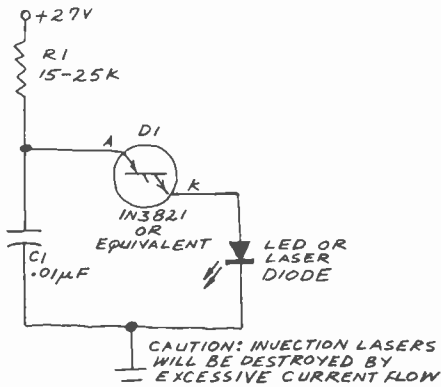

Fig. 4. Four-layer diode LED and injection laser driver.

for the speaker. The 500-ohm potentiometer permits the amplitude of the output pulses to be varied between zero and the firing voltage of the four-layer diode. The small resistor (3.3-10 ohms) limits the output current and protects *D1* from being damaged by excessive current flow in the event the output is shorted directly to ground.

My favorite application for the four-layer diode relaxation oscillator is as a subminiature, high-current driver for infrared LED's and semiconductor injection lasers. Figure 4 shows a circuit using only three components which easily delivers 10-ampere pulses with a width of about 100 nanoseconds and a rate of about a kilohertz to a diode laser. A typical experimenter-grade laser diode will deliver up to several watts of invisible infrared at a wavelength of about 900 nanometers when driven by this circuit. Laser, pulser, and batteries can be easily built into a small pocket-size package. A simple lens can be added to squeeze the broad beam from the laser into the pencil-thin beam produced by the much more costly gas lasers.

Be sure to keep the leads between the laser and the pulser short and direct if you try this circuit. Excess lead length can induce negative overshoot currents of several amperes, enough to damage or destroy the laser. It's very important to keep the pulse current below the maximum allowable for a particular laser. If you have access to a fast (25 MHz or so) scope, you can see the pulses delivered to the laser. Insert a 1-ohm resistor (fixed carbon; *not* wirewound) between the laser and ground and connect the scope across it. Since the resistance is one ohm, the voltage seen on the scope equals current in amperes through the laser.

You can also try building a four-layer diode audio oscillator to become familiar with the operating simplicity of this often overlooked parts saver. ◇

# FREE McIntosh CATALOG and FM DIRECTORY

Get all the newest and latest information on the new McIntosh Solid State equipment in the McIntosh catalog. In addition you will receive an FM station directory that covers all of North America.

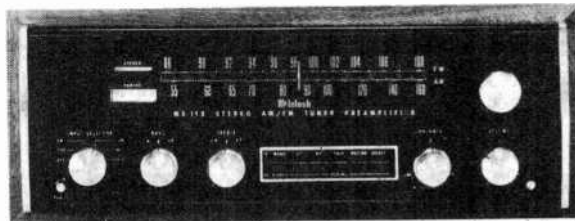

## MX 113

FM/FM STEREO - AM TUNER AND PREAMPLIFIER

**SEND TODAY!**

McIntosh Laboratory, Inc.  
East Side Station P.O. Box 96  
Binghamton, N.Y. 13904  
Dept. PE

NAME \_\_\_\_\_  
ADDRESS \_\_\_\_\_  
CITY \_\_\_\_\_ STATE \_\_\_\_\_ ZIP \_\_\_\_\_

If you are in a hurry for your catalog please send the coupon to McIntosh. For non rush service send the Reader Service Card to the magazine.

CIRCLE NO. 34 ON FREE INFORMATION CARD

### BUILD YOUR OWN

## BIG SCREEN COLOR TV!

- Sporting Events Are An Experience As Exciting as Being There!
- Movies Are Seen The Way They Were Meant To Be Seen!
- Pong And Other Video Games Are More Exciting Than Ever!
- Can Be Used With Video Tape Playback Equipment!

THE NEW LIFESCREEN II

WE HAVE RECEIVED THOUSANDS OF INQUIRIES!

YOU REQUESTED PLANS FOR A BIG SCREEN TV THAT WOULD: utilize any portable TV as an image source - require a minimum of floor space - be a beautiful piece of furniture.

NOW - EXTRON IS HAPPY TO ANNOUNCE

THE ORIGINAL LIFESCREEN I



The SELF-CONTAINED internal projection TV that will utilize any transistor portable TV (12" to 19")... requires only 2 x 4 feet of floor space - fits neatly against any wall... and lends its beauty to the decor of any room.

- COMPONENT LIST
- 1 set of LIFESCREEN II Plans
  - 1 Portable transistor Color TV (12" to 19")
  - 1 LIFESCREEN Lens
  - 2 LIFESCREEN Front Surface Mirrors - one 8"x10" and one 14"x20"
  - 1 EXTRON LS 50 Screen, 32"x40"/50" Diag.

The LIFESCREEN was designed for the Do-It-Yourself enthusiast who wishes to have the enjoyment and excitement of a professional Big Screen TV - but refuses to pay the \$1500 to \$4000 that most manufacturers charge for this luxury.

#### FACTS

The special LIFESCREEN, Lens and Front Surface mirror supplied by Extron are the same type used by major Big Screen TV manufacturers (Sony, Muntz, etc.). THESE PROFESSIONAL COMPONENTS SHOULD NOT BE CONFUSED WITH THE CHEAP PLASTIC MAGNIFYING IMITATIONS NOW FLOODING THE MARKET BECAUSE OF THE POPULARITY OF BIG SCREEN TV.

The EXTRON TV Screen - the same used by the major Big Screen TV manufacturers - is 16 TIMES BRIGHTER than a flat matta surface and 6 TIMES BRIGHTER than most flat beaded movie screens. Its parabolic shape rejects extraneous light, concentrating a highly efficient and directionally selective television image that is exceptionally sharp and colorful.

COMPLETE LIFESCREEN II PACKAGE: \$299

COMPLETE LIFESCREEN I PACKAGE: \$269

THE EVERYTHING GUARANTEE  
EXTRON GUARANTEES EVERYTHING: THE PROFESSIONAL QUALITY, ACCURACY OF DESCRIPTION, AVAILABILITY AND PROMPT DELIVERY OF COMPONENTS DESCRIBED IN THIS AD. If, after building your LIFESCREEN PROJECTION SYSTEM, you are not satisfied for any reason, return all components to EXTRON, 8831 Sunset Boulevard, West Hollywood, California for instant refund of the purchase price.

The INDEPENDENT projection system that can be used with ANY SIZE screen up to 80" Diagonal - one of the many reasons for its tremendous success.

- COMPONENT LIST
- 1 set of LIFESCREEN I Plans
  - 1 Sharp 15" Model 13A21 Color TV or Sony 15" Model KV 1541R Color TV.
  - 1 LIFESCREEN Lens
  - 1 LIFESCREEN Front Surface Mirror, 8" x 10"
  - 1 EXTRON LS 50 Screen 32"x40"/50" Diagonal

LARGER SCREENS can be ordered through EXTRON 67" or 80" Diag.

PLEASE RUSH ME ONE COMPLETE SET OF LIFESCREEN I PLANS ..... @ \$9.00

PLEASE RUSH ME ONE COMPLETE SET OF LIFESCREEN II PLANS ..... @ \$9.00

PLEASE ALSO SEND ME THE ITEMS CHECKED BELOW

LIFESCREEN LENS ..... @ \$150.00

LIFESCREEN FRONT SURFACE MIRROR, 8" x 10" ..... @ \$20.00

LIFESCREEN FRONT SURFACE MIRROR, 14" x 20" ..... @ \$30.00

EXTRON LS 50 SCREEN 32" x 40"/50" Diagonal ..... @ \$90.00

COMPLETE LIFESCREEN I PACKAGE ..... @ \$269.00

COMPLETE LIFESCREEN II PACKAGE ..... @ \$299.00

NAME \_\_\_\_\_

ADDRESS \_\_\_\_\_

CITY \_\_\_\_\_ STATE \_\_\_\_\_ ZIP \_\_\_\_\_

CARD NUMBER \_\_\_\_\_

EXPR. DATE \_\_\_\_\_

8831 Sunset Boulevard, West Hollywood, California 90069

INFO PAK - 50c

All Prices F.O.B. factory - Cal. residents add 6% sales tax.

TOTAL: \$ \_\_\_\_\_

CIRCLE NO. 20 ON FREE INFORMATION CARD





# Product Test Reports

## PRESIDENT "WASHINGTON" AM/SSB CB BASE STATION

40-channel transceiver can be powered by ac line or 13.8-volt dc.



**T**HE "WASHINGTON" from President electronics is a sophisticated 40-channel AM/SSB CB base station transceiver. It is designed for operation from a 117-volt ac line source, but also may be powered from a nominal 13.8-volt dc supply with negative or positive ground.

Digital frequency synthesis and numeric LED channel indicators are used in the transceiver. Among its other features are: PHONE jack; VOLUME control; RF GAIN and SQUELCH controls; MIKE GAIN control; AM/USB/LSB mode selector; CLARIFIER control; PA/CB and NB (noise blanker) pushbutton switches, the latter with a noise limiter; illuminated s/RF PWR meter; LED mode indicators; front-facing speaker; transmitter-on LED; external-speaker jack; low-level clipper with filter; automatic modulation control (amc); automatic level control (alc) for SSB operation; electronic voltage regulation; reverse-polarity protection; and a line filter for dc sources.

The transceiver measured 13½" W × 11"D × 5"H (34.3 × 28 × 12.7 cm) and weighs 13.8 lb (6.3 kg). Supplied with microphone and mobile mounting hardware, it retails for \$429.95.

**Technical Details.** Frequency control of the transceiver is provided by a PLL (phase-locked loop) synthesis system. A single-conversion receiver is employed, with the PLL's voltage-controlled oscillator (vco) operating in the area of

35 MHz to produce a 7.8-MHz i-f. A diode-protected r-f stage precedes the FET mixer.

A simple crystal bandpass filter following the mixer minimizes unwanted-signal responses, while a multisection crystal-lattice filter provides AM adjacent-channel rejection and sideband selection on SSB. Three i-f stages, the second and third of which are dc coupled, provide high gain with good stability. Separate voltage-doubling diodes are used for the S meter, for which there is an additional i-f amplifier, AM detection, and the agc. The last is amplified along with the r-f gain and controls a transistor that functions as a variable attenuator at the input to the r-f amplifier. A product detector is provided for SSB.

The anl for AM is the usual type and is followed by an audio amplifier and an IC power-output stage that also provides the modulating signal on AM. An amplified squelch is agc activated. The noise blanker employs the usual setup. It functions at 23 MHz to prevent triggering by CB signals and is switched in along with the anl.

A 10,240-kHz crystal-controlled signal is divided down to 10,000 Hz to provide the standard PLL reference. Then an 11,285-kHz crystal signal is tripled, difference-mixed with the output of the vco, and divided (according to the channel selector position). This provides the vco comparison signal at the phase comparator that furnishes the control voltage

for the vco. All dividing and phase comparison are accomplished in a single integrated circuit.

On transmit, the 11,825-kHz crystal signal is replaced by a ±800-Hz signal (depending on whether AM, USB, or LSB is selected). When tripled, this signal generates a total change of ±2400 Hz. This signal is then mixed with one of two carrier-oscillator signals, again depending on the mode of operation, that are also shifted ±2400 Hz from 7800 kHz.

The output of the vco is sum-combined at a transmitter mixer with the nominal 7800-kHz signal to provide the on-channel frequency. However, on SSB, the 7800-kHz signal is first modulated and the carrier suppressed at a balanced modulator. After this, the desired sideband is selected by the crystal-lattice filter.

The mixer is followed by an r-f amplifier, predriver, driver, and the r-f power amplifier stages. The power amplifier includes a three-section output network with a TVI trap. On SSB, the power amplifier functions as a linear amplifier, as do the preceding stages. On AM, the power amplifier and driver are collector modulated.

A bootstrap setup around an IC microphone amplifier provides compression with this amc augmented by a low-level clipper. This is followed by a dual-section low-pass audio filter that minimizes frequencies above about 2500 Hz. This scheme eliminates out-of-band distortion that might otherwise produce splatter due to the internal clipping action. The overall result is extremely effective in preventing overmodulation while still allowing high average modulation without splatter. Similar results are obtained on SSB, where the low-level clipper is engaged along with an alc setup.

Transmit/receive transfer is accomplished with a relay, along with electronic switching.

**Laboratory Measurements.** In our laboratory measurements, we obtained the following results. The sensitivity of the receiver measured 0.55 μV on AM with 30% modulation at 1000 Hz and less than 0.2 μV on SSB for 10 dB (S + N)/N. Image, i-f, and other unwanted-signal rejection all measured greater than 75 dB. Adjacent-channel rejection, desensitization, and crossmodulation were in the range of 55 to 60 dB. The squelch threshold range was 0.4 to 1000 μV. The agc figure of merit was 13 dB of audio change with a 20-dB r-f input change at 1 to 10 μV, 16 dB of audio

change with an 80-dB r-f change at 1 to 10,000  $\mu$ V.

An S9 indication on the S meter was obtained with a 50- $\mu$ V signal. Unwanted-sideband suppression measured greater than 60 dB at 1000 Hz. The overall response was 200 to 2000 Hz on AM and nominally 50 to 2700 Hz on SSB. The audio output measured 3.5 watts at 3% THD with a 1000-Hz test signal on receive and 3.75 watts on PA.

The noise blanker allowed 0.5-to-1- $\mu$ V signals to be readable with only a trace of background noise in the presence of impulse noise 100 dB above 1  $\mu$ V/MHz bandwidth. Pulses 70 dB above 1  $\mu$ V were all subdued.

The AM carrier output was 4 watts when the transceiver was operated from the ac line. On SSB, the output was 12 watts pep with a test tone and 14 to 16 watts with voice modulation. Maximum AM modulation at input levels 25 dB above that required for 50% modulation were 90% on the positive peak and 85% on the negative peak at 6% THD with a 1000-Hz signal. The THD increased to 20% during maximum clipping at 400 Hz. Adjacent-channel splatter with voice or steady 1000-Hz modulation was a minimum of 60 dB down. It was in the

range of 55 to 60 dB at 2500 Hz. The peaks occasionally hit 100% with voice modulation.

Third-order distortion products on SSB were 26 dB below two test tones, or 32 dB below the pep output, using maximum microphone gain and alc, which allowed high average modulation without distortion-causing flat-topping. Unwanted-sideband suppression at 1000 Hz was greater than 50 dB and carrier suppression was 60 dB.

**User Comment.** This is an impressive looking transceiver, matching its fine performance. The channel-selector knob is large and easy to handle. Much to our delight, there are no concentric controls to confuse the CB'er. The controls are arranged in logical order along the bottom of the front panel. The mode-indicating LED's are ideally located above the mode switch, and the channel displays are large and easy to read.

Another nicety is that the lighted meter is large and round for easy reading. The power scale's calibration at the point labelled "4" coincides closely with the actual AM r-f output power. Should the user switch to PA, however, he will learn that the meter is not illuminated,

nor are there any other indicators that the transceiver is "on."

One of the fine performance features of this transceiver is its modulation. As noted by our tests, the transceiver provides a high average modulation level for a good punch, with the modulation peaks held to just short of 100%. This produces a clean signal without splatter, even with the MIC GAIN control fully turned up. However, it must be recognized that although the clipper's low-pass filter minimizes distortion products outside of the channel being used, distortion from heavy clipping can appear in the transmitter's audio passband. (The passband was nominally 260 to 2700 Hz on AM and 400 to 2500 Hz on SSB.) In this respect, the response varied somewhat with different microphone levels due to variations in the clipping levels at various frequencies. The Washington's front-facing speaker enhances voice intelligibility and the phone jack permits private monitoring.

With the exception of an SWR indicator, the Washington CB transceiver from President Electronics has everything you will need for convenient base-station use on both AM and SSB.

CIRCLE NO 104 ON FREE INFORMATION CARD

## FLUKE MODEL 8020A DIGITAL MULTIMETER

*3½ digits, 6 functions, 28 ranges.*



**F**LUKE'S new Model 8020A digital multimeter has a number of innovative features wrapped up in a rather small package for portable use. It features a 3½-digit liquid crystal display (LCD) and low-current IC's to permit up to 200 hours of continuous operation from a single replaceable 9-volt alkaline

battery. In addition to the usual voltage, current, and resistance measuring capabilities, the new DMM has a novel "conductance" function that offers the user the capability of measuring transistor beta and high-resolution resistance up to 10,000 megohms.

The DMM measures 7¼"L x 3¾"W x 1½"D (18.1 x 8.6 x 3.8 cm) and weighs 13 oz (560 g). \$169.

**General Details.** The DMM offers six functions and 26 ranges, all selectable by pushing in the appropriate switches located along the left side of the case. The functions include ac and dc current and voltage, resistance, and conductance. The accuracy on all functions and ranges is specified at 0.25%. Transient protection for up to 6000 volts is provided, as are automatic zeroing and automatic polarity indication.

Ac and dc voltages can be measured on five ranges that go up in decade steps from 200 mV to 1000 volts full-scale on dc and 750 volts on ac. Input resistance/impedance in both cases is 10 megohms (paralleled by less than 100 pF on the ac ranges). On dc, the input is protected up to 1000 volts on all ranges, while on ac, protection is provid-

ed for up to 300 volts rms on the 200-mV range and up to 750 volts rms on the higher ranges. Accuracy on dc is 0.25% +1 count and on ac is a function of frequency, going from a low of 0.75% +2 counts up to 1000 Hz to a high of 5% +5 counts at 5000 Hz. The normal-mode rejection is 60 dB at 50/60 Hz, while common-mode rejection is 100 dB at dc and 50/60 Hz.

Six ranges are provided for the resistance-measuring function, each going up in decade steps from 200 ohms to 20 megohms full-scale. Accuracy is stated as ranging from 0.2% on the lower ranges to 2% on the 20-megohm range. Full-scale test voltages on the 200-ohm, 20k, and 2-megohm ranges is 0.25 volt; greater than 0.7 volt on the 200k and 20-megohm ranges; and less than 1 volt on the 2k range. The open-circuit voltage is rated at less than 3.5 volts on the 2k range and less than 1.5 volts on all other ranges. Note that the test voltages are arranged so that on the 200-ohm, 2k, and 2-megohm ranges silicon diodes will not conduct when taking a resistance measurement in a circuit across a semiconductor junction. Overvoltage protection up to 300 volts dc and ac rms is provided on all ranges.

Put Professional Knowledge and a  
**COLLEGE DEGREE**  
 in your Electronics Career through  
**HOME STUDY**

**Earn Your DEGREE**

by correspondence, while continuing your present job. No commuting to class. Study at your own pace. Learn from complete and explicit lesson materials, with additional assistance from our home-study instructors. Advance as fast as you wish, but take all the time you need to master each topic. Profit from, and enjoy, the advantages of directed but self-paced home study.

The Grantham electronics degree program begins with basics, leads first to the A.S.E.T. degree, and then to the B.S.E.E. degree. Our free bulletin gives complete details of the program itself, the degrees awarded, the requirements for each degree, and how to enroll. Write for *Bulletin E-77*.

**Grantham College of Engineering**  
 2000 Stoner Avenue  
 P. O. Box 25992  
 Los Angeles, CA 90025

Worldwide Career Training thru Home Study  
 CIRCLE NO. 23 ON FREE INFORMATION CARD

**FREE EICO CATALOG**

**358 Ways To Save On Instruments, CB, Burglar Alarms, Automotive & Hobby Electronics!**

The more you know about electronics, the more you'll appreciate EICO. Every EICO product is designed to provide you with the most pleasure and quality performance for your money. The fact that more than 3 million EICO products are in use attests to their quality and performance.

**"BUILD-IT-YOURSELF" and save up to 50% with our famous electronic kits.**

For the latest EICO Catalog and name of nearest EICO Distributor, check reader service card or send 50¢ for fast first class mail service.

EICO—283 Malta Street, Brooklyn, N.Y. 11207

Leadership in creative electronics since 1945.



CIRCLE NO. 16 ON FREE INFORMATION CARD

The conductance function allows high-resistance measurements to be made to an equivalent of 10,000 megohms. This allows the user to test for capacitor leakage and check the condition of diodes, cables, etc. In addition, by using an external socket and a single resistor, transistor beta can be measured directly. This handy function makes transistor matching a snap.

Two conductance ranges are provided: 2 mS and 2 nS (S stands for Siemens, which replaces the formerly used mho). Accuracy is rated at 0.3% +1 count on the 2-mS and 2% +10 counts on the 2-nS ranges. The open-circuit test potential is less than 1.5 volts dc on both ranges, and both ranges will forward bias a typical transistor junction.

Four decade ranges are provided for making current measurements on ac and dc, starting with 2 mA and ending with 2000 mA (2 A) full-scale. Accuracy on dc is rated at 0.75% +1 count on all ranges. On ac, the accuracy is stated at 2% +2 counts between 45 and 450 Hz on the 2-mA range and 1.5% +2 counts on all other ranges between 45 and 1000 Hz. In both modes, the insertion drop is specified at 0.7 volt on the 2000-mA range and 0.25 volt on all other ranges. Overcurrent protection is provided for up to 2 A on all ranges in both modes, and the inputs are fuse-protected when measuring current in circuits where the open-circuit potential is 250 volts or less.

**User Report.** We tested the DMM in our usual manner, using a laboratory voltage reference standard and a variety of 1% and 0.1% precision resistors of known values. Our results verified that the meter was within the published specifications—in most cases, well within the specs—on the resistance and ac and dc voltage functions and ranges.

We used our voltage reference and 0.1% tolerance resistors to then check the accuracy of the current-measuring functions. Though we did not attempt to make current measurements greater than 250 mA, the results obtained leave no doubt that here, too, the instrument performed well within its published specifications.

The DMM is housed in a high-impact plastic case, on which we performed our usual drop test from a height of 1 meter onto a hardwood floor. Needless to say, the instrument survived the test. We performed the laboratory tests again and discovered that our results were no different from those we had obtained before the drop test.

We like the location of all the operating switches along the left side of the instrument's case. This makes for convenient one-hand operation of the DMM. Another plus is that the test-lead input jacks are deeply recessed into the case, which makes it virtually impossible for a user to accidentally bridge the inputs with his hand when making high-voltage measurements.

The large 7/16" (11.1-mm) high numerals in the display are dead black against the light metallic background, which makes them easy to read under almost all lighting conditions. Being a liquid crystal display, it requires very low current to operate, which is the primary reason an ordinary 9-volt alkaline battery delivers such a long operating life. In fact, during our field tests of the DMM we rarely ever turned off the power when we were on a job. And replacement of the battery is a simple operation. A cover at the bottom rear of the case slides out to allow the battery (and the fuse, which is mounted in a block atop the battery clip) to be replaced at a moment's notice.

We performed some transistor beta tests according to the instructions given in the manual supplied with the DMM. To our surprise, the Model 8020A DMM came up with almost identical readings as those obtained on our laboratory-grade transistor tester.

Although the conductance mode was new to us, it did not take us long to gain familiarity with it. The operating manual illustrates a conductance-to-resistance conversion table that can be used for exacting measurements. Essentially, the conductance function allows the DMM to make measurements out to 10,000 megohms, which is not possible with ordinary multimeters, even DMM's. This capability is ideal for checking capacitors and cables for leakage and semiconductors for forward/reverse ratios.

When the potential from the battery drops below 7.2 volts, the display indicates BT to inform the user that only 20% of the battery's life remains.

After using the Model 8020A digital multimeter on our workbench and in the field for some time, we conclude that it is an excellent instrument for the engineer, technician, and hobbyist. It is rugged, easy to use, and provides more than enough accuracy for most any measuring task. Moreover, its conductance function expands the meter's versatility. It is also quite reasonably priced for what it offers in the way of test and measurement capabilities.

CIRCLE NO. 105 ON FREE INFORMATION CARD

# THE FEEL OF MUSIC

The Realistic<sup>®</sup> Mach One isn't just for your ears!

**Multicell midrange horn**

Provides a true spatial image. Smooth 800-8000 Hz response for a "live" presence.

**Heavy-duty tweeter horn**

Delivers crisp and clean highs from 8000 to 25,000 Hz.

**Treble, midrange L-pads**

Calibrated controls for precise adjustment of response to suit room acoustics.

**Oiled walnut veneer**

We make speaker positioning easy by including a cabinet with the look and feel of fine furniture — so the Mach One looks great anywhere!



**Massive  
15" woofer**

The acoustic suspension, large-excursion cone has an effective radiating area of over 100 square inches—the equivalent of a huge air-pump — for bass you can feel all the way down to 20 Hz. The four-layer voice coil is wound on a brass form for heavy power handling capacity—over 100 watts peak program material.

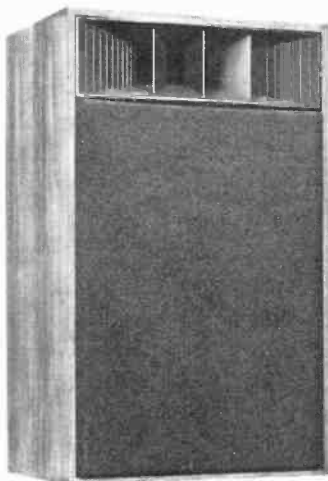

**Removable grille**

The sturdy grille frame snaps on and off for easy access to the response controls.

A great loudspeaker doesn't just please your ears. It reproduces deep bass with a power and punch your entire body feels . . . it recreates the live ambience so accurately that when you close your eyes, you're "on location" in that auditorium, concert hall or night spot . . . and it delivers top performance with both moderate and high-powered amplifiers. If you think we're talking about a \$400 speaker, you haven't experienced the Mach One. For under \$200 each\*, you get incredible "live theatre" sound from a name you can depend on: Realistic. Backed by 56 years in audio design, manufacture, sales and service. So bring in your favorite record for a Mach One audition, and discover the feel of music.

SOLD ONLY WHERE YOU SEE THIS SIGN:

**Radio Shack<sup>®</sup>**

A TANDY COMPANY • FORT WORTH, TEXAS 76107  
OVER 5000 LOCATIONS IN NINE COUNTRIES

CIRCLE NO. 47 ON FREE INFORMATION CARD



These two credit cards honored at most Radio Shacks.

\*Price may vary at individual stores and dealers.



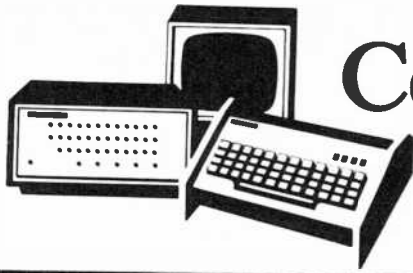

# Computer Bits

By Leslie Solomon, Technical Editor

## REMOTE CONTROL

There has been lots of *talking* in various computer circles about the possibility of using a computer and a special program to control appliances around the house. However, there has been very little *doing* on the subject after the expense of the necessary rewiring was calculated.

While considering this problem at one club meeting, I was reminded of an article published in this magazine some time ago that just might be of some help. The article was "Wireless Audio System for Remote Speakers" (January 1976) and it described the concept of using a wide-band (30 Hz to 17 kHz) FM carrier-current transmitting system operating at approximately 200 kHz, to pipe hi-fi music around the house using the ac power lines already existing in the structure. Wherever you wanted a loudspeaker, you merely installed a matched FM carrier-current receiver and used the audio output from this device to operate the remote speaker system.

Now, why couldn't the same idea be applied to a computer system since just about every structure where a computer is installed is already wired and the existing power lines could be used: The only requirement is to substitute discrete tone signals for the hi-fi music. Since the wireless system has excellent specifica-

tions (S/N is  $-65$  dB, frequency response is 30 Hz to 17 kHz  $\pm 0.2$  dB, and audio distortion is less than 2%), good results could be expected.

Although I am still in the process of building what I am about to describe, I want to pass the idea along so that any one who is interested can make his own modifications or redesign the system for better operation.

**Modulating With a Program.** The first requirement is a program that will turn on an audio tone generator at a frequency determined by a given command. This tone is then used to modulate the wireless intercom system. A separate decoder can be installed in each room where there are appliances to be controlled and each decoder supplies a number of output signals.

The decoded outputs could be used to turn on an SCR or triac, which, in turn, would supply power to a conventional appliance socket. If each socket is color-coded, or otherwise identified as to which tone turns it on, the computer can control power to any socket in the system. To avoid having to keep a tone on-line while each socket is powered, the decoded output pulse can be used to turn on a flip-flop that operates the SCR or triac. Thus, the first transmitted tone

turns on a socket. Then, because of the flip-flop action, the socket remains powered even when the tone is removed. The second time the tone occurs, the power is removed from the socket.

Because of the 30-Hz-to-17-kHz bandwidth of the system, quite a number of discrete tones can be transmitted. The use of high-Q filters can increase even that number.

**The Circuits.** Transmitter and receiver circuits that can be used are shown here. Note that both are connected directly to the ac power line, so great care must be taken when working with the circuit to avoid electrical shock.

In the transmitter, which will be located at the computer, the selection of  $R1$  and  $C1$  will determine the oscillation frequency. In the circuit shown,  $C1$  can be about  $0.001 \mu\text{F}$ , while  $R1$  is in the range of 1500 to 4700 ohms for a transmitting frequency of about 300 kHz. Other values may be used to set the desired operating frequency. Although you can use a single resistor for  $R1$ , switches may be used to select other values for other frequencies. In the circuit shown, transmission gates (TG) such as the CMOS 4016 can be operated by a computer signal. If desired, simple pushbutton switches can be used.

The output of the transmitter's 567 drives a transistor emitter follower (any good silicon type can be used) with the output passing through a high-pass filter to the ac line.

The receiver section to control only one socket is shown. Its input is coupled to the power line through a high-pass filter which also includes diode signal clipping (optional). The  $R1$ - $C1$  combination in the receiver is selected to mate with that used in the transmitter. The decoded tone output, which occurs when the 567 receives the correct frequency, is

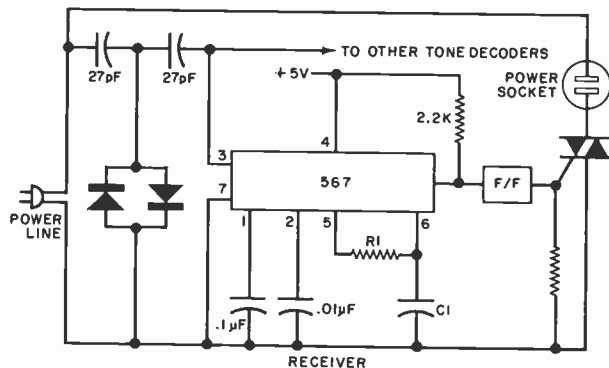
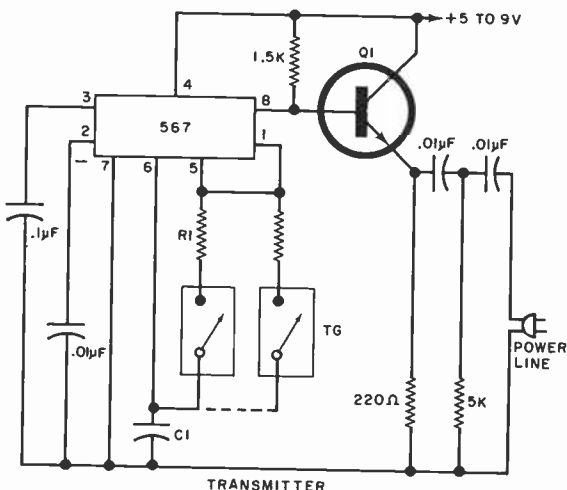

Transmitter (left) and receiver (above) circuits for a wireless system of remote control by computer.

used to operate the flip-flop. This stage, in turn, drives the SCR or triac. This controls the ac line supply to the power socket.

When the correct frequency is received, the flip-flop turns on the SCR or triac. The latter then remains on even when the tone is removed. When the correct frequency is detected the second time, the flip-flop changes states. Then, at the next zero crossing of the power supply, the triac is turned off, removing power from the controlled appliance. As previously mentioned, this system has not been built, but it looks workable. The reader can select his own frequencies, method of keying the tones, type of flip-flop, etc.

**Suggestions.** It is also possible to use a conventional wireless intercom system, available from most electronics parts distributors and catalogs. They can be modified to use tone generators at the transmitter end and phase-locked loops (like the 567) at the receiver end.

No matter what kind of system you use, the important thing is to remember that any home, farm, or factory wired for power is automatically wired for remote control. All you have to do is generate the correct activating signals.

**Newsbreak.** There have been rumors in the wind for more than a year now that Heath, among other well-known companies, was planning to introduce a hobbyist computer. Well, it has happened! Heath has entered the hobby computer field. Here is a brief description of what was shown to us at a Heath press conference in Benton Harbor, Mich.

Based on the 8080A microprocessor, the new Heath H8 Digital Computer (kit price \$375) features a 1k ROM operating system, a 9-digit, 7-segment LED octal display and a 16-key keypad. The readouts are used to display register and memory contents, even when the machine is running. Four discrete LED's are used as system status indicators, while a built-in loudspeaker can be used for a variety of audio effects.

The bus design features two 25-pin connectors, and the bus has provisions for 10 plug-ins. The plug-in boards are tilted at the same angle as the sloping front panel. The "edge" connectors are on one side, and the other side of each board is supported by a metal bracket. The chassis is convection-cooled by a series of louvers on the top and bottom surfaces.

The kit contains everything but RAM memory. A 4k static RAM board kit is



*Heathkit H8 digital computer.*

available for \$140, and a 4k chip set to expand the board to 8k costs \$95. There is also a serial I/O board that contains a 1200-baud audio cassette (modified Manchester code, KC standard) for \$110, and a three-port parallel I/O for \$150.

The Heath H9 CRT terminal (kit price \$350) features a 67-key board, and an 80-character by 12-line display on its built-in 12" glare-free monitor. Other features include a format option of four columns of 20 characters by 12 lines, full cursor control, batch transmit, and a plot mode. Standard serial I/O includes EIA (RS-232), 20-mA current loop, and TTL levels. The baud rate is selectable between 110 and 9600.

There are several other items in the Heath computer line, including the H11, a 16-bit machine for \$1295. Based on the Digital Equipment Corp. LSI-11 microcomputer module (KD11-F), and featuring the PDP-11 software, this new computer comes with a wired and tested CPU board, and 4k x 16-bit RAM memory. The memory is expandable to 20k. The system includes a built-in back-



*Heathkit H9 CRT terminal.*

plane, power supply with switching regulators and full circuit protection, and I/O accessories. A complete DEC software package that includes an editor, PAL-11 assembler, linker, on-line debug package, I/O executive, BASIC and FOCAL, is also included. Accessories include a 4k x 16-bit RAM board at \$275, a serial and a parallel interface at \$95 each. Purchasers of the H11 are eligible to join DECUS (Digital Equipment Computer Users Society), whose library contains over 800 programs for the PDP-11 which can be run on the H11.

Another new item is the Heath H10 paper tape reader-punch for \$350. Although intended for the Heath H8 and H11 computers, the H10 can be used with any other computers. This peripheral employs standard 1"-wide paper tape (roll or fan fold), and the reader operates at 50 characters per second and is silent. The tape punch operates at 10 characters per second and either function is independent of the other and may be operated simultaneously. The device also features a copy mode for tape duplication, a built-in power supply, and a stepper motor for the reader tape drive. The interface is standard parallel TTL.

Heath will also make available the LA36 DEC Writer II for use with their computer systems. This hard copy device features variable-width forms from 3" to 14 $\frac{7}{8}$ " wide, 128-character ASCII upper/lower case set with 95 printable characters, 132-column print format with 10 characters per inch horizontal and 6 lines per inch vertical spacing. It can handle up to 6 part forms with 0.020" maximum pack thickness. Other features include half- or full-duplex, parity check on output ANSI-standard multi-key rollover, and a keyboard similar to that on a typewriter. The LA36 uses a 20-mA current loop interface. ◇

# SAVE!

MONEY • TIME • FREIGHT

- ♪ QUALITY STEREO EQUIPMENT AT LOWEST PRICES.
- ♪ YOUR REQUEST FOR QUOTATION RETURNED SAME DAY.
- ♪ FACTORY SEALED CARTONS—GUARANTEED AND INSURED.
- ♪ SAVE ON NAME BRANDS LIKE:
 

A.D.C.	KLH
A.R.	SHURE
DYNACO	KOSS
SONY	FISHER

PIONEER  
AND MORE THAN 50 OTHERS  
BUY THE MODERN WAY  
BY MAIL—FROM

## illinois audio

Department 217S  
12 East Delaware  
Chicago, Illinois 60611  
312-664-0020

CIRCLE NO. 24 ON FREE INFORMATION CARD

# CB

where the  
ACTION'S  
at

Millions of 2-way CB radios are in use—millions of new ones are being sold annually to new CBers and for replacing old units—what a market for repair service. It's the biggest thing in electronics since color TV. There's only one thing wrong with CB growth—the lack of technicians capable of servicing CB radios. That's why many TV shops are expanding into CB and why new CB shops are opening up all over the country. Going CB servicing rates run from \$12 to \$24 per hour.

To get into CB radio servicing, full-time or part-time, you need test equipment, an FCC operator license and to learn how. To learn how, you can buy the **CB RADIO REPAIR COURSE** for cash, on a monthly payment plan, or charge the cost to your BankAmericard or Master Charge account.

To make it easy to study, this 70-lesson course employs the **PROGRAMMED** teaching technique and sticks to the target—CB radio. Study at your own pace as you receive the self-examining lessons. We can't guarantee that you will become a CB expert since that depends on you.

To get the facts about this course, write a letter or card or mail the coupon below today. No salesman will call.

**CB RADIO REPAIR COURSE, INC.**

Dept. PE-087

531 N. Ann Arbor  
Oklahoma City, OK 73127

Please send information about your Course to:

Name \_\_\_\_\_  
Address \_\_\_\_\_  
City \_\_\_\_\_ State \_\_\_\_\_ Zip \_\_\_\_\_

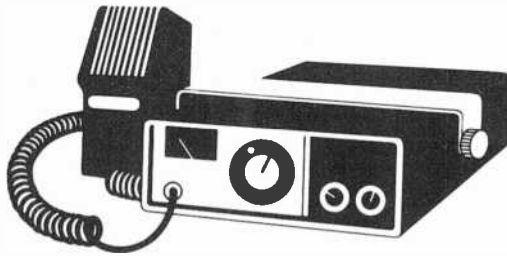

## CB Scene

By Ray Newhall, KW1G010

### CB DEVELOPMENT NEWS AND VIEWS

**M**UCH HAS BEEN written in this column and others about the future of personal use radio, but soon many of these futuristic dreams may come true as CB technology moves into the realm of computer electronics.

As CB has taken the public fancy, FCC license holders have increased from fewer than a million in January, 1974 to a reported 12 million in 1977. It has been estimated that more than 20,000,000 rigs are now in active use in the U.S.

CB Radio has not only caused shifts in sociological habits of the American public, but it has also created new problems. There are noticeable increases in r-f radiation levels in all parts of the country as the public use of radiotelephone has increased, which includes more users in the business, marine, and the amateur services.

No one has yet suggested a health hazard, to the best of our knowledge, but the r-f background levels are very evident to TV viewers and audiophiles.

TVI (television interference) and audio rectification have become commonplace, and the FCC is under tremendous pressure from the public and from Congress to resolve the problem.

At the same time, with better than one in ten Americans using CB, the FCC is also being pressured to make more of the radio spectrum available for personal use. It was this pressure from both camps that precipitated the sudden 40-channel rule-making in July, 1976. In one quick decision, the FCC increased the number of channels from 23 to 40 and clamped down drastically on harmonic emissions and chassis radiation standards for new transceivers, all effective January 1, 1977.

The 40-channel rule-making was very nearly disastrous for CB manufacturers, all of which had built up huge inventories in anticipation of a banner sales year. Stock was introduced to the market at prices at or below cost in an attempt to reduce inventories. But at these bargain prices, the public just kept buying 23-channel transceivers, even though new 40-channel models were introduced. Profit margins had disappeared at the same time manufacturers were required to invest heavily in new research to meet the 1977 technical standards for type acceptance. Even so, several large appliance and electronic component manufacturers became newly committed to the CB market.

Now, a year later, the upheaval has not subsided entirely. In early spring there were still about a million new 23-channel rigs on dealers' shelves. Again, manufacturers were forced to reduce prices, this time on 40-channel units to make them more competitive; only top-of-the-line equipment was able to resist this price erosion. Of course, surviving manufacturers began looking for ways to make their expensive rigs look more attractive to the CB public. Their new ideas are beginning to appear in the



Hy-Gain's Model 2716 40-channel Remote CB Mobile Transceiver.

CIRCLE NO. 11 ON FREE INFORMATION CARD

# Fill your needs from these 3 winning lines from Mallory.

Each of these Mallory lines of components is bubble-packed, easily identified. Almost all feature basic specs and/or instructions on the back of the cards.

Mallory EPC components consist of the most popular products for technicians, hobbyists and audio enthusiasts.

Mallory PTC semiconductors are of the highest quality. They fill a wide range of consumer and industrial applications. A convenient cross-referencing catalog permits fast selection.

Mallory crimp-type solderless terminals meet virtually all popular applications.

For all the facts and pricing, see your Mallory distributor. Or write Mallory Distributor Products Company, a division of P. R. Mallory & Co. Inc., Box 1284, Indianapolis, Indiana 46206. (317) 856-3731.



Mallory crimp type solderless terminals.

Popular components in Mallory Electronic Parts Center (EPC).

Mallory PTC semiconductors.

# MALLORY

Capacitors • Controls • Fastening Devices • Resistors • Security Products • Semiconductors • Solderless Terminals • Switches



1978 models, which were on display at a trade show early this year.

On the whole, the CB boom has brought about significant improvement in design and production of high quality, low cost CB rigs, and should improve the status of all radiotelephone equipment. Type-accepted transceivers on the market in 1977 are greatly improved over the units sold only a couple of years ago. Major improvements have been made in less interference- and distortion-causing operation and improved reliability, as well as 17 additional channels. Speech-processing circuits have

been redesigned to meet stricter modulation requirements, and adjacent channel interference reduced. To be more competitive, nearly all rigs operate close to maximum permissible power, with high modulation.

With the advent of the expansion to 40 channels, digital logic has become commonplace. PLL frequency synthesis is the most economic route to go to achieve 17 more channels, of course. And this design permits channels to be displayed digitally.

**A Shift Of Emphasis.** As mentioned

earlier, many CB manufacturers (including surprising new entries to the industry, such as Texas Instruments) are planning to extend their use of digital logic into functions that had never occurred to most of us only a couple of years ago. Some, including Hy-Gain, and TI, are planning to introduce CB rigs in 1978 which incorporate microprocessor logic into the control units of their top-of-the-line sets. Hy-Gain has demonstrated a controller much like a telephone handset, which incorporates push-button control and digital display of

The one you've been waiting for. That lets you take your own mobile CB anywhere: Fishing, hunting, camping. Boating, biking, snowmobiling. On sports cars, motorcycles, golf carts. On the job, farm, ranch. A portable of 101 uses!

## NEW! THE BATTERY PACK THAT MAKES YOUR CB A PORTABLE

All the power of a mobile . . . with the convenience of a walkie-talkie, that's the new KENDON Power-Mate a quality battery pack that enables you to take your 23 or 40 channel CB into the field as a mobile/portable.

### LOOK AT THESE FINE FEATURES

- Built-in coax fine tuned antenna extends your range. Telescopes to 4' length. Stores in its own protected base.
- Full 13.5 volt power supply outperforms hand held units. Delivers maximum wattage output for long range communications.
- Compact carrying case has universal mount, adapter hardware to take most standard size 12-volt CBs, 23 or 40 channel. Easy hookup.
- Constructed of tough high density styrene, case is shatterproof, shock resistant. Weighs only 10 oz. w/out batteries. Measures 10.1x7x4 in.
- Has battery test meter and switch. Handy side mount for mike. Comfortable carrying strap.
- Uses 9 standard C-size or rechargeable nicad batteries (not included).

Save now! Soon to be nationally retailed for \$39.95.

**\$34<sup>95</sup>**

Complete this form or call toll-free 800-621-8318\* and order direct by charge cards shown below. \*Illinois residents call 800-972-8308

Kendon Manufacturing Co.  
Division of Univex International  
3636 S. Jason St.  
P.O. Box 1977  
Englewood, Colo. 80150

Please ship:

CB Power-Mate  
(quantity) power pack unit at \$34.95 each (plus \$3.00 shipping).

Enclosed is my check or money order for

Or please charge my order to:

BankAmericard  
 Master Charge\*

Acct. No. \_\_\_\_\_

Exp. Date \_\_\_\_\_

\*If using Master Charge, also indicate the four numbers above your name here \_\_\_\_\_

Signature \_\_\_\_\_  
(must be signed to be valid)

I understand that if I am not fully satisfied I may return these items in their original condition within 15 days for a full refund.

NAME \_\_\_\_\_

ADDRESS \_\_\_\_\_

CITY \_\_\_\_\_

STATE \_\_\_\_\_

ZIP \_\_\_\_\_

Please allow 4 weeks for delivery.



Texas Instruments' hand-held unit includes digital SWR readout.

channel number, signal strength and an LED digital clock, as well as a separate mike and earphone. Texas Instrument's offering will be similar to Hy-Gain's, but will include SWR readout on its digital display. Features such as channel recall memory and instantaneous channel 9 switching will be included on some transceivers.

**Proposals For The Future.** Robert Beeman of Berkley, Illinois, has formally presented the FCC with a plan to expand personal radio service into a 2-MHz band between 48 to 50 MHz, just below the six meter amateur band. His proposal, labeled RM-2849 by the FCC, recommends the assignment of 99 narrow-band FM channels for personal use.

The proposal analytically examines the usable radio spectrum and concludes that any new allocations must be above 40 MHz in order to eliminate ionospheric propagation (skip), and below 300 MHz because he judges that technical sophistication, high cost and high propagation losses make uhf unsuitable for a personal use radio service.

Mr. Beeman's proposal places major emphasis on problems associated with TVI (television interference), and recommends that any CB frequency allocation should be removed from the closest TV channel by at least four MHz, and that i-f

beat characteristics be carefully analyzed. He eliminates the 220 MHz band (proposed by the EIA in 1968 for Class "E" CB) because it has just such an i-f beat relationship to TV channel 7.

Although Mr. Beeman concludes that the only suitable allocation would be from 48 to 50 MHz, he is quick to add that even this band has drawbacks (but no major ones which cannot be overcome by modern technology):

- \* The band is too close to TV channel 2, and also to the TV i-f frequency band between 41 to 47 MHz.

- \* Ionospheric "skip" still exists at 48 MHz, but it is infrequent and of short duration.

The advantages he lists for the recommended band are:

- \* It is presently little used, as compared with the other options available below 400 MHz. These frequencies are now assigned primarily to industry and miscellaneous governmental agencies.

- \* Six-meter antennas would be convenient for mobile use, yet antenna systems and propagation would be far more efficient than frequencies above 200 MHz.

- \* There is room in this band for 99 narrow-band FM channels, separated by 16 kHz spacing (transmitter frequency tol-

erances would be limited to  $\pm 1$  kHz, or .002%).

The 99 channels would be allocated as follows:

- \* 70 channels for 5 watt simplex voice transmission
- \* 18 channels (9 pairs) for duplex wireless telephone
- \* 5 R/C channels using digital coding
- \* 5 low power walkie-talkie channels
- \* 1 channel reserved for digitally-encoded automatic selective calling.

The automatic digital calling channel would be used by transceivers equipped for selective calling. A *calling* unit might select any unused channel and dial in the identification of the unit he wishes to contact. At the push of a button, a digitally-encoded tone-burst message would be transmitted on the reserved channel (channel zero). When received by the *addressed* unit, the transceiver would be automatically switched to the channel specified in the message format, the selective squelch disabled, the calling unit identified by a digital display and the receiving operator alerted to receive the incoming call. Such equipment could be programmed to respond automatically to calls on the designated emergency channel.

Mr. Beeman's suggestion for a channel reserved for digital selective calling shows excellent foresight that's well within present day digital logic capability. It would provide high-grade, private personal communications, especially if repeaters, privacy scramblers and auto patches were one day permitted as they are on the Class A band.

**Another ATIS Proposal.** There has been another automatic transmitter identification signal (ATIS) proposal submitted to the FCC by the chairman of the PURAC User Rules Task Group, Stu Lippoff, in a report of Minutes of a January 29th meeting. It is a detailed plan for mandatory ATIS applied to the present CBRS band. Although it appears to be a minority report of his own concepts rather than a consensus report by Task Group members, it does reflect some of the concern felt about CBers who refuse to identify themselves routinely by use of a call sign.

This columnist would welcome the inclusion of ATIS devices as a required part of any newly authorized band in the Personal Use Radio Service, but would resist any attempt to retrofit current CB equipment with ATIS devices. ◇

# ok® wire wrapping center ok®

**NEW HOBBY WRAP**  
MODEL BW 630



Battery  
wire  
wrapping  
tool

**\$34.95**  
ONLY  
COMPLETE WITH BIT  
AND SLEEVE

**STRIP/WRAP/UNWRAP**  
MODEL WSU-30



**\$5.95\***

**RIBBON CABLE**  
ASSEMBLY

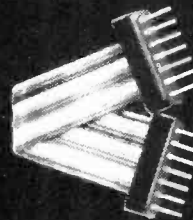

**DIP SOCKETS**

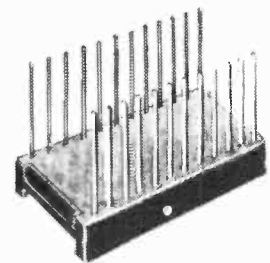

**DIP IC INSERTION**  
TOOL WITH PIN  
STRAIGHTENER

MODEL  
INS-1416



**\$3.49\***

**WIRE DISPENSER**  
MODEL  
WD-30-B

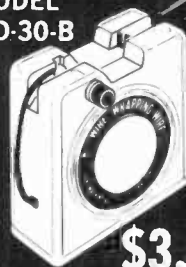

**\$3.45\***

**PRE-CUT**  
PRE-STRIPPED WIRE

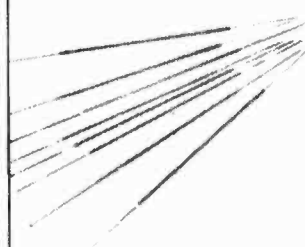

**WIRE WRAPPING KIT**

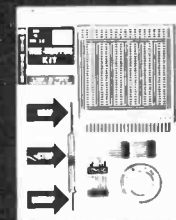

**\$15.45\***

\*MINIMUM ORDER \$25.00. SHIPPING CHARGE \$1.00. N.Y. CITY AND STATE RESIDENTS ADD TAX

## OK MACHINE AND TOOL CORPORATION

3455 CONNER STREET, BRONX, NEW YORK, N.Y. 10475 U.S.A.  
PHONE (212) 994-6600 TELEX NO. 125091

# ELECTRONICS MARKET PLACE

**REGULAR CLASSIFIED: COMMERCIAL RATE:** For firms or individuals offering commercial products or services, \$2.25 per word. Minimum order \$33.75. **EXPAND-AD CLASSIFIED RATE:** \$3.35 per word. Minimum order \$50.25. Frequency discount; 5% for 6 months; 10% for 12 months paid in advance. **READER RATE:** For individuals with a personal item to buy or sell, \$1.35 per word. No minimum! **DISPLAY CLASSIFIED:** 1" by 1 column (2-1/4" wide), \$260.00. 2" by 1 column, \$520.00. 3" by 1 column, \$780.00. Advertiser to supply film positives. For frequency rates, please inquire.

**GENERAL INFORMATION:** Payment must accompany copy except when ads are placed by accredited advertising agencies. First word in all ads set in caps. All copy subject to publisher's approval. All advertisers using Post Office Boxes in their addresses **MUST** supply publisher with permanent address and telephone number before ad can be run. Advertisements will not be published which advertise or promote the use of devices for the surreptitious interception of communications. Ads are not acknowledged. They will appear in first issue to go to press after closing date. Closing Date: 1st of the 2nd month preceding cover date (for example, March issue closes January 1st. Send order and remittance to **POPULAR ELECTRONICS**, One Park Avenue, New York, New York 10016. Attention: Hal Cymes.

## FOR SALE

**FREE!** Bargain Catalog—I.C.'s, LED's, readouts, fiber optics, calculators parts & kits, semiconductors, parts. Poly Paks, Box 942PE, Lynnfield, Mass. 01940.

**GOVERNMENT** and industrial surplus receivers, transmitters, snooper scopes, electronic parts, Picture Catalog 25 cents. Meshna, Nahant, Mass. 01908.

**LOWEST Prices** Electronic Parts. Confidential Catalog Free. KNAPP, 3174 8th Ave. S.W., Largo, Fla. 33540.

**ELECTRONIC PARTS**, semiconductors, kits. **FREE FLYER.** Large catalog \$1.00 deposit. BIGELOW ELECTRONICS, Bluffton, Ohio 45817.

**RADIO—T.V. Tubes—36 cents** each. Send for free catalog. Cornell, 4213 University, San Diego, Calif. 92105.

**AMATEUR SCIENTISTS**, Electronics Experimenters, Science Fair Students... Construction plans—Complete, including drawings, schematics, parts list with prices and sources... Robot Man — Psychadelic shows — Lasers — Emotion/Lie Detector — Touch Tone Dial — Quadraphonic Adapter — Transistorized Ignition — Burglar Alarm — Sound Meter... over 60 items. Send 50 cents coin (no stamps) for complete catalog. Technical Writers Group, Box 5994, University Station, Raleigh, N.C. 27607.

**METERS—Surplus**, new, used, panel or portable. Send for list. Hanchett, Box 5577, Riverside, CA 92507.

**MECHANICAL, ELECTRONIC** devices catalog 10 cents. Greatest Values — Lowest Prices. Fertik's, 5249 "D", Philadelphia, Pa. 19120.

**POLICE/Fire scanners**, large stock scanner crystals, antennas. Also CBs. Harvey Park Radio, Box 19224, Denver, CO 80219.

**TELETYPE EQUIPMENT** for sale for beginners and experienced computer enthusiast. Teletype machines, parts, supplies. Catalogue \$1.00 to: ATLANTIC SALES, 3730 Nautilus Ave., Brooklyn, NY 11224. Tel: (212) 372-0349.

**ELECTRONIC ignition:** Capacitor-Discharge, pointless. Auburn Sparkplugs. Wheel Stabilizers. Information 20 cents. Anderson Engineering, Epsom, N.H. 03234.

**WHOLESALE C.B.s., Scanners, Antennas, Catalog 25 cents.** Crystals: Special cut, \$4.95, Monitor \$3.95. Send make, model, frequency. G. Enterprises, Box 461P, Clearfield, UT 84015.

**COMPUTER HOBBYISTS—classified advertising newsletter.** \$3.75/year. Free Sample. **ON LINE**, 24695 Santa Cruz Hwy., Los Gatos, CA 95030.

**SOUND SYNTHESIZER KITS—Surf \$12.95, Wind \$12.95, Wind Chimes \$17.95, Electronic Songbird \$6.95, Musical Accessories, many more. Catalog free. PAIA Electronics, Box J14359, Oklahoma City, OK 73114.**

**BUGGED???** New locator finds them fast. Write, Clifton, 11500-L N.W. 7th Avenue, Miami, Florida 33168.

**YOU WILL SAVE BIG MONEY!** Surplus, Clearouts, Bankruptcy, Inventory, Deals. Catalog \$1 (redeemable). ETCOA Electronics, Box 741, Montreal, H3C 2V2. U.S. Inquiries.

**HEAR POLICE/FIRE Dispatchers!** Catalog shows exclusive directories of "confidential" channels, scanners. Send postage stamp. Communications, Box 56-PE, Commack, N.Y. 11725.

**UNSCRAMBLERS:** Fits any scanner or monitor, easily adjusts to all scrambled frequencies. Only 4" square \$29.95, fully guaranteed. Dealer inquiries welcomed. PDQ Electronics, Box 841, North Little Rock, Arkansas 72115.

**RECONDITIONED Test Equipment.** \$0.50 for catalog. Walter's Test Equipment, 2697 Nickel, San Pablo, CA 94806.

**SURPLUS 'SMART' TERMINALS,** components, serious music synthesizer kits, plans, parts, and more. Send SASE for **FREE INFO Package.** CFR Associates, POBF, Newton, N.H. 03858.

**CB RADIOS,** monitors, crystals, CD ignitions. Southland, Box 3591-B, Baytown, Texas 77520.

**ORGAN KITS  
KEYBOARDS**

THE ULTIMATE IN DESIGN  
AND SOUND

Demo Record & Brochure \$1.00

Wurlitzer reproductions

**DEVTRONIX ORGAN PRODUCTS, Dept. C**  
5872 Amapola Dr. • San Jose, CA 95129

1. SEND FOR OUR FREE CATALOG — THOUSANDS OF SURPLUS BARGAINS AVAILABLE FOR HOBBYIST & ENGINEER

**TV REMOTE CONTROL UNIT**



A universal control unit operates your TV at your command from up to 35 feet away. Fits all sets with standard VHF turret tuners, changes channels as well as turning TV on or off. New, with instructions. Qty. Ltd. Sh. Wt. 15 Lbs: 7M170225...\$39.95 ea. \$150.00 for 4

**TV TENNIS GAME**



1 or 2 players - 1 to 10 ball speed - dual paddle size - sound. These are questionable games returned to mfr for one reason or another. He is too busy to repair and needs mfg room. His loss, your gain. Complete with schematic. Contains 20-74LS series chips power supply & other stuff. Designed by MIT. Sh. Wt. 4 Lbs. 7ZU70161...\$10.00 ea. \$38.88 for 4

---

**TOUCH-TONE GENERATOR CHIP**



1/2w 2 of 8 encoder chip ME8900, (similar to the MC14410). Sold with data sheet on uses of MC14410 chip. No crystals required. Sh. Wt. 8 oz. 7VL70160...\$6.95 ea. \$60.00 for 10

**STATIC CHARACTER GENERATOR MM 5240**

64 - 8x5 character, 2560-bit. With data. Sh. Wt. 8 oz...71C70231...\$6.00 ea.

---

**POWER SUPPLY KITS**



1. **C.B. POWER SUPPLY KIT**  
A complete kit which puts out 10 to 24 VDC at 2 amps regulated, 115 VAC in. Can be wired for constant 13.8VDC, ideal & compact for C.B. Kit includes PC board all components and instructions! Just add your case Super bench supply!  
Sh. Wt. 6 Lbs. 6C60498...\$14.88

2. **5 A, 10 to 24 VDC Reg. P.S. KIT**  
A simple, adjustable regulated power supply. Kit includes all components vector board and complete schematics. All you add is the case. Powerful!  
Sh. Wt. 15 Lbs. 6M160301...\$14.88

3. **0 to 30 V AC/DC P.S. KIT**  
This high amp adjustable supply is an easy kit to build. It includes a 0 to 40 volt autotransformer (Variac®), 24V 5A xformer and all other components. Useful as a battery charger bench supply or any use requiring high current. Qty. Ltd. Sh. Wt. 9 Lbs...6C60462...\$14.50

POSTAGE: Please add postage.

PHONE ORDERS WELCOME! (617) 531-5774 - BANKAMERICAN - MASTER CHARGE - AMERICAN EXPRESS ACCEPTED

**FOR FASTER SERVICE**

**USE ZIP CODE**

**on all mail**

---

**COLOR TV CHASSIS**  
TS-951 & TS-953

We have found some 2,000 damaged TV chassis, of the same types that we have been selling these last few months, except that these have cracked PC boards, bent frames, etc. The parts alone are worth 5 times as much as our low prices. All units are sold "AS IS", all sales are final. 13" & 15" include tuners. Sh. Wt. 12 Lbs. each.

13" Chassis...7DZ70059...\$22.50  
15" Chassis...7DZ70060...\$22.50  
17" Chassis...7DZ70061...\$14.88  
19" Chassis...7DZ70062...\$14.88

---

**FANTASTIC SPEAKER CABINETS**



Fantastic air suspension enclosures, designed for direct dispersion of the hi-frequency driver and wide dispersion of the woofer. By adding the proper speakers you can obtain a freq. resp. of 30 to 20,000 Hz. Size: 17" x 10" x 9 1/2". Requires an 8" woofer and a 4" tweeter. Sold with grill cloth and instructions to build your own speaker system. Sh. Wt. 25 Lbs...Order No. 70B70200 \$25.00/pair...or...\$80.00 for 4 pairs  
Phone Orders Welcome! (617) 531-5774  
Just Say "Charge It!"

---

**B&F ENTERPRISES**  
119 FOSTER STREET  
PEABODY, MASS. 01960  
617-531-5774  
Charges Welcome

**B&F**

For faster service

USE ZIP CODE

on all mail

**BUILD YOUR OWN SPEAKERS AND SAVE UP TO 50%**

Send for our free fact-packed 44-page catalog, manual and learn how to assemble your own multi-element stereo speakers from scratch or from kits. Our catalog includes chapters on design, construction, x-overs, enclosures, midrange, woofers, tweeters and horns. Write us today!

**SPEAKER LAB**  
Dept. PE-A, 5500 35th N.E.  
Seattle, Washington 98105



**BUILD AND SAVE. TELEPHONES, TELEVISION, DETECTIVE, BROADCAST** Electronics. We sell construction plans with an Engineering Service. Speakerphones, Answering Machines, Carphones, Phonevision, Dialers, Color TV Converters, VTR, Games, \$25 TV Camera, Electron Microscope, Special Effects Generator, Time Base Corrector, Chroma Key, Engineering Courses in Telephone, Integrated Circuits, Detective Electronics. **PLUS MUCH MORE.** NEW Super Hobby Catalog PLUS year's subscription to Electronic News Letter, \$1.00. Don Britton Enterprises, 6200 Wilshire Blvd., Los Angeles, Calif. 90048.

**NAME BRAND Digital/Analog Test Equipment.** Discount prices. Free catalog. Salen Electronics, Box 82, Skokie, Illinois 60076.

**SURPLUS COMPONENTS,** Communication and test equipment. Illustrated catalog 25 cents. E. French, P.O. Box 249, Aurora, Illinois 60505.

**TELEPHONES UNLIMITED, Equipment, Supplies,** All types, Regular, Keyed, Modular. Catalog 50 cents. Box 1147E, San Diego, California 92112.

**FREE CATALOG.** Solar Cells, Nicads, Kits, Calculators, Digital Watch Modules, Ultrasonics, Strobes, LEDs, Transistors, IC's, Unique Components. Chaney's, Box 27038, Denver, Colorado 80227.

**POWERFUL, ADJUSTABLE, REGULATED, THREE OUTPUT POWER SUPPLY** and 900 easily removable parts in complete CARTRIVISION television recorder electronic assembly with documentation. Perfect for MICROPROCESSOR, IC, transistor, television, CB radio applications. \$21.45. Free brochure. MADISON ELECTRONICS, INCORPORATED, 369, D55, Madison, Alabama 35758. **SATISFACTION GUARANTEED.**

**CARBON FILM RESISTORS 1/4W, 1/2W - 1.7 cents** each. **FREE** sample / specifications. Other components. COMPONENTS CENTER, Box 134P, New York, N.Y. 10038.

# Radio Hut

Money back guarantee. NO COD'S. Texas residents add 5% sales tax. Add 5% of order for postage and handling. Orders under \$15.00 add 75 cents. Foreign orders add 10% for postage.

For your convenience, call your BankAmericard or Master Charge orders in on our Toll Free Watts Line: 1-800-527-2304. Texas residents call collect: 1-214-271-8423.



P. O. Box 64783P  
Dallas, Texas 75206



Memorex computer boards with IC's, diodes, transistor, etc. 5 Boards containing 100 - 200 IC's  
**ONLY \$4.25**

## BRIDGE RECTIFIERS

6 Amp	50V	1.10
10 Amp	50V	1.25
25 Amp	50V	1.39

## RESISTORS

Over 50,000,000 in stock

330 ohm	27K ohm
470 ohm	27K ohm
680 ohm	33K ohm
1K ohm	39K ohm
1.2K ohm	43K ohm
2.2K ohm	47K ohm
3.3K ohm	82K ohm
4.7K ohm	100K ohm
6.8K ohm	150K ohm
10K ohm	270K ohm
20K ohm	

1/8 W only  
1/2 W only

All resistors are P.C. Lead but are not pull offs  
100 min. order for each value

NO MIX 100/99

## MK 5005

4 digit counter/latch decoder; 7 segment output only. 24 pin dip with specs.  
**\$ 8.00 EACH**

## UNSCRAMBLER KIT for all Scanners

- Tunes easily
  - Full instructions included
  - Easy to install
  - 3 1/2" x 3 1/2" x 1 1/2"
- Only \$19.95**

## PLASMA DISPLAY KIT

Kit Includes: 12 digit display .4" Character Power supply for display above Complete specs for hookup.

Line cord Not Included. **ONLY \$ 3.95**

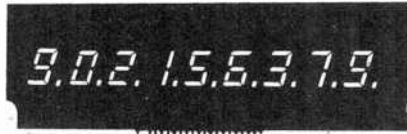

## SPECIAL DEVICES

82S23	2.19
2513	10.00
2102-1	.99
1101A	.75
1103A	1.10
8T13	1.50
8T97	1.25
MM5233	1.50
300KC xtal	1.50

## REGULATORS

7805	7818
7806	7824
7808	7905
7812	7912
7815	7915

**Your Choice \$ .95**

## READOUTS

- Best Value!**
- FND70 .4"C.C. .59  
FND800 .8"C.C. 1.69  
TI 6 digit array C.C. 3/1.00  
MAN 8 .3"CA Yellow .89  
LT767 .7"C.C. 4 digit stick **\$ 3.95**



## WATERGATE SPECIAL

Telephone Relay automatically starts and stops tape recorder. No batteries required. Kit complete with drilled P.C. Board.  
Parts and Case **ONLY \$ 10.95**



## VARIABLE POWER SUPPLY KIT NO. 1

- \*Continuously variable from 5V to 20V
  - \*Excellent regulation up to 500 mil.
  - \*4400 Mfd of filtering
  - \*Drilled fiberglass PC Board
  - \*One hour assembly
  - \*Kit includes all components
  - \*Case Included
- ONLY \$ 10.95**

## VARIABLE POWER SUPPLY KIT NO. 2

Same as above but with 1 amp output, also with case.  
**ONLY \$ 13.95**

## CLOCK KIT



- Kit includes
- LT701 clock module
  - Power Supply
  - Punched Case
  - 12 or 24 hour operation

Complete except for line cord  
LT701E 12 hour clock

**ONLY \$ 14.95**

## BATTERY CLIPS

Standard 9V battery clip with 4-1/2" tinned leads. 25/\$1.00

## TRANSISTORS DIODES

*MJE1103	3/1.00
MJ3001	1.30
2N2222	6/1.00
2N2369	6/1.00
2N2905	4/1.00
*2N2907	15/1.00
2N3906	6/1.00
2N4400	6/1.00
2N4443 SCR	3/1.00
1N4004	15/1.00
1N4007	10/1.00
1N4148 (1N914)	20/1.00
3N201 VHF Pre amp	.80
D40C1 Power Darl - 8/1.00	.20
EN930	.25
1N746	.25

\*House numbered and P.C. Lead

## PC BOARDS

4 digit PCB for FND800 or 807	2.50
6 digit PCB for FND800 or 807	3.50
4 digit PCB for DL 707	1.50
6 digit PCB for DL 707	2.00
4 digit PCB for FND503 or 510	2.00
6 digit PCB for FND503 or 510	3.00
4 digit PCB for DL 747	2.50
6 digit PCB for DL 747	3.00
4 digit PCB for DL 727 or 728	2.00
6 digit PCB for DL 727 or 728	3.00
4 digit PCB for FND359 or 70	1.75

NOTE: All PC Boards are multiplexed for adding additional digits.

## SOCKETS

14 pin	.22
16 pin	.25
18 pin	.25
24 pin (ww only)	.95
28 pin	.35
40 pin	.50

## CMOS SALE

CD4000	.16
CD4001	.16
CD4002	.16
CD4007	.16
CD4009	.45
CD4010	.45
CD4011	.16
CD4012	.16
CD4013	.29
CD4014	.75
CD4015	.75
CD4016	.29
CD4017	.80
CD4018	.80
CD4019	.39
CD4020	.85
CD4021	.90
CD4022	.90
CD4024	.70
CD4025	.19
CD4027	.39
CD4028	.75
CD4029	.99
CD4030	.16
CD4034	2.30
CD4035	.99
CD4040	1.00
CD4041	.69
CD4042	.59
CD4043	.60
CD4044	.59
CD4046	.90
CD4047	.59
CD4049	.35
CD4050	.35
CD4051	.90
CD4053	.90
CD4056	1.00
CD4058	.90
CD4060	1.00
CD4066	.69
CD4069	.30
CD4071	.16
CD4076	.99
CD4077	.29
74C107	.29
CD4116	.39
CD4507	.40
CD4512	.50
CD4516	.85
CD4518	.85
CD4520	.85

## LS

74LS00	.26	74LS145	1.00
74LS02	.26	74LS151	.70
74LS03	.26	74LS153	.70
74LS04	.30	74LS155	.69
74LS05	.32	74LS156	.76
74LS08	.26	74LS157	.95
74LS09	.26	74LS158	.85
74LS10	.26	74LS160	.85
74LS11	.35	74LS161	.85
74LS13	.58	74LS162	.85
74LS14	1.05	74LS163	.85
74LS15	.26	74LS168	.85
74LS20	.24	74LS169	.85
74LS21	.35	74LS170	2.00
74LS22	.35	74LS173	1.10
74LS26	.35	74LS174	1.00
74LS27	.35	74LS175	1.00
74LS30	.34	74LS190	.95
74LS32	.35	74LS191	.95
74LS37	.33	74LS192	.95
74LS38	.38	74LS193	.95
74LS40	.34	74LS194	.95
74LS42	.80	74LS195	.95
74LS51	.26	74LS196	.85
74LS54	.26	74LS197	.85
74LS55	.26	74LS298	.85
74LS73	.75	74LS253	.85
74LS74	.49	74LS257	.85
74LS76	.49	74LS258	.85
74LS86	.45	74LS260	.26
74LS90	.85	74LS266	.26
74LS92	1.00	74LS279	.55
74LS93	1.00	74LS290	.75
74LS109	.49	74LS293	.75
74LS112	.49	74LS295	.95
74LS114	.40	74LS298	.95
74LS125	.55	74LS365	.55
74LS126	.65	74LS366	.55
74LS132	1.00	74LS368	.55
74LS133	.35	74LS390	1.75
74LS136	.39	74LS393	1.45
74LS138	.85	74LS670	3.25
74LS139	.85		

ORDER BY PHONE. Charge your order to BankAmericard or Master Charge.

USE OUR TOLL FREE WATTS

**1-800-527-2304**

## 60 Hz L(•)(•)K

### Crystal Time Base Kit - Kit

enables a MOS clock circuit to operate from a DC power source. Ideal for car, camper, van, boat, etc. 60Hz output with an accuracy of .005% (typ.) Low power consumption 2.5 ma (typ.). Small size will fit most any enclosure. Single MOS IC oscillator/divider chip 5-15 volts DC operation.

**ONLY \$ 5.95**  
**2 for \$10.00**

## RADIO HUT GUARANTEE

If you are not satisfied with any of our products NO MATTER WHAT THE REASON we offer you a full money back guarantee if the product or products are returned within 14 days after you receive them.



**S.D. SALES CO. P.O. BOX 28810 - D DALLAS, TEXAS 75228**

**Z-80 CPU KIT  
For Imsai-Altair  
\$149. kit**

Z-80 Chip & Manual \$49.95

From the same people who brought you the \$89.95 4K RAM Kit. We were not the first to introduce an Imsai/Altair compatible Z-80 card, but we do feel that ours has the best design and quality at the lowest price!  
The advanced features of the Z-80 such as an expanded set of 158 instructions, 8080A software compatibility, and operation from a single 5VDC supply, are all well known. What makes our card different is the extra care we took in the hardware design. The CPU card will always stop on an M1 state. We also generate TRUE SYNC on card, to insure that the rest of your system functions properly. Dynamic memory refresh and NMI are brought out for your use. Believe it or not, not all of our competitors have gone to the extra trouble of doing this.  
As always this kit includes all parts, all sockets, and complete instructions for ease of assembly. Because of our past experience with our 4K kit we suggest that you order early. All orders will be shipped on a strict first come basis. Dealers inquiries welcome on this item. Kit includes Zilog Manual and all parts. Kit shipped with 2 MHZ crystals.  
Z-80 MANUAL - \$7.50 SEPARATELY

**THE WHOLE  
WORKS  
\$89.95**

**4K LOW POWER RAM BOARD KIT**

Imsai and Altair 8080 plug in compatible. Uses low power static 21L02-1 500 ns. RAM'S. Fully buffered, drastically reduced power consumption, on board regulated, all sockets and parts included. Premium quality plated through PC Board.  
For 250 ns RAM's add \$10.00

*Music to your Ears!*  
**CAR/BOAT KIT  
\$34.95**

**NEWEST KIT FROM S.D. SALES!  
MUSICAL HORN**

**HOME KIT  
\$19.95**

Musical Horn Kit for Car, Boat or Home  
Plays any tune from Mozart to Led Zeplin  
Change tunes in seconds  
Complete Solid State electronics  
Standard or custom tunes available at \$6.95 each (you supply us with the sheet music - we supply electronics for your favorite tunes.)  
One song supplied with original order

Standard Tunes Available:  
DIXIE - EYES OF TEXAS - ON WISCONSIN -  
YANKEE DOODLE DANDY - NOTRE DAME  
FIGHT SONG - PINK PANTHER - AGGIE WAR  
SONG - ANCHORS AWAY - NEVER ON SUNDAY  
BRIDGE OVER RIVER QUI - CANDY MAN  
Home Kit includes speaker which operates from your door bell. When door bell is pushed your favorite tune is played. Car/Boat Kit DOES NOT include speaker. Uses standard 8ohm PM speaker. Allow 4 weeks delivery on both kits.

*Limited Quantity!*  
**\$9.95 kit**

**SIX DIGIT ALARM CLOCK KIT**

We made a fantastic kit even better. Redesigned to take advantage of the latest advances in I.C. clock technology. Features: Litronix Dual 1/2" displays. Mostek 50250 super clock chip, single I.C. segment driver, SCR digit drivers. Greatly simplified construction. More reliable and easier to build. Kit includes all necessary parts (except case). For P.C. Board add \$3.00; AC XFMR add \$1.50. Do not confuse with Non-Alarm kits sold by our competition! Eliminate the hassle - avoid the 5314!  
NEW! WITH JUMBO LED READOUTS!

1000 MFD  
Filter Caps  
Rated 35 WVDC Up-  
right style with PC  
leads. Most popular val-  
ue for hobbyists.  
4/\$1.00

SLIDE SWITCH  
Assortment  
Our best seller. Includes  
miniature and standard  
sizes, single and multi-  
position units. All new.  
12/\$1.00

POWER  
RESISTOR  
15 OHM  
25W  
BY  
CLAROSTAT  
75¢ ea.

RESISTOR  
ASSORTMENT  
1/4W 5% & 10% PC  
leads. A good mix of  
values! Special!  
200/\$2.

P.C. LEAD  
DIODES  
1N4148/1N914  
100/\$2.00  
1N4002-1A  
100 PIV  
40/\$1.

Just received a good  
mixed lot of National  
TO-92 plastic transis-  
tors: PNP & NPN, even  
a few FET's. 40-50%  
yield. Untested Ass't.  
500/\$3.

DISC CAP  
ASSORTMENT  
P.C. Leads. At least  
10 different values.  
Includes .001, .01, .05  
plus other standard  
values.  
60/\$1.00

**AMD-1702A**  
*Huge Factory Purchase*  
FACTORY PRIME UNITS! BRAND NEW!  
1.5 Micro-Seconds Access Time.  
10/\$40. \$4.95 ea.

**IC's from XEROX**

7400 - 9c	7430 - 9c	7493 - 26c	1402 A Shift Regulator - 50c
7402 - 9c	7440 - 9c	74121 - 22c	MH0025CN - 55c
7404 - 9c	7437 - 10c	74123 - 32c	
7406 - 11c	7438 - 10c	74151 - 9c	IC's REMOVED FROM
7407 - 11c	7451 - 9c	74155 - 22c	PC BOARDS
7410 - 9c	7474 - 16c	74193 - 35c	ALL TESTED;
7416 - 13c	7475 - 24c	8233 - 35c	FULL SPEC.
7420 - 9c	7486 - 16c	Intel - 1302 - 45c	

**UP YOUR COMPUTER!  
21L02-1**

And so is power! Not only are our RAM'S faster than a speeding bullet but they are now very low power. We are pleased to offer prime new 21L02-1 Low Power and Super Fast RAM's. Allows you to STRETCH your power supply farther and at the same time keep the wait light off!

500 ns 8/\$12.95  
250 ns 8/\$15.95

**\$12.95 S.D. Sales Exclusive! \$12.95**

**MOS 6 DIGIT UP/DOWN COUNTER**

40 PIN DIP. Everything you ever wanted in a counter chip. Features: Direct LED sement drive, single power supply (12 VDC TYPE.), six decades up/down, pre-loadable counter, separate pre-loadable compare register with compare out-put, BCD and seven segment out-puts, internal scan oscillator, CMOS compatible, leading zero blanking. 1MHZ. count input frequency.  
VERY LIMITED QUANTITY!

**Special!**

28 PIN IC  
Sockets  
3/\$1.00

3.579545  
MHZ Time  
Base Crystal  
\$1.25

39 MFD  
16V Mallory  
Electrolytic  
15/\$1.00

**TERMS:**

**MONEY BACK  
GUARANTEE!**

No COD's. Texas Resi-  
dents add 5% Sales Tax.  
Add 5% of order for post-  
age & handling. Orders  
under \$10. add 75c. For-  
eign orders: U.S. Funds  
Only!

Call in your BANKAMERICARD  
or MASTER CHARGE order in on  
our Continental United States Toll  
Free Watts Line:

**1-800-527-3460**

Texas Residents Call Collect:

**214/271-0022**

**Cheap DC Supply**

Actually an AC adap-  
tor for calculators.  
9VDC no load. 6VDC  
@200ma. 4VDC @  
375ma.

**\$2. ea.**

S. D. SALES CO.  
P.O. BOX 28810 - D  
DALLAS, TEXAS 75228

**Orders over \$15. - Choose \$1. FREE MERCHANDISE!**

# Barrel Bustin' Blast=off

Avg. Ship. Wt. 6-ozs.



Buy from the **BARRELS n'SAVE!**

EXCLUSIVE AT POLY PAKS

Test 'em yourself and save!  
Kits include 100% material, too!  
Each kit carries a money-back guarantee!

Buy 10 BARREL KITS AND CHOOSE THE 11TH KIT FREE

<b>BARREL KIT #239 SHIELDED CABLE 50-ft. \$1.98</b> For mikes, stereos; 1-cond. plus shield, 22 ga. vinyl jacket. Wt. 1 lb. BE3577	<b>BARREL KIT #230 HALF INCH READOUTS \$1.98</b> BE3629 From factory to you! Includes Fairchild FND-500 & 507's.	<b>BARREL KIT #225 SOUND TRIGGERS 3 for \$1.98</b> "Hand clap" sensitizes crystal mike amplifier, triggers SCR. Cat. No. BE3625	<b>BARREL KIT #221 IC SOCKETS 8 for \$1.98</b> hobby Mir unloaded Four 14-pin, four 18-pin. Sold tall, Performed. No. BE3621	<b>BARREL KIT #205 MINI BLOCK CAPACITORS 50 for \$1.98</b> Unbelievable! Worth \$50. High precision submini caps for all applications. Wt. 3 ozs. Cat. No. BE1528	<b>BARREL KIT #203 CALCULATOR KEYBOARDS 10 for \$1.98</b> It's true! 20-key, 4 function keyboards at ridiculous give-away. Wt. 12 ozs. Cat. No. BE3524	<b>BARREL KIT #210 1/4" GLOW-IN-THE-DARK PANELS 3 for \$1.98</b> 4" x 1 1/2" panels that glow blue-green with 110V AC. Use for nite lites, indicators, etc. Cat. No. BE3550
<b>100 for \$1.98 #202 PLUGS, SOCKETS, DISTRIBUTOR UNIONS</b> Includes AC, DC, RF, audio clips, 4-2 pin, all kinds. Wt. 1 lb. Cat. No. BE3527	<b>BARREL KIT #201 6V INDICATORS w/leads 15 for \$1.98</b> Test lamp manufacturer's worth dumps inventory! Worth 69¢ ea. Like grain-o-wheat. Cat. No. BE3526 hobby	<b>BARREL KIT #200 9 DIGIT READOUT MODULES 5 for \$1.98</b> with calculator driver chips bonded epoxy. Cat. No. BE3515	<b>BARREL KIT #208 400 Parts \$1.98</b> Includes resistors, caps, transformers, rectifiers, diodes, etc. for p.c. work. Catalogued into barrels by factories. 100%. Cat. No. BE3401	<b>BARREL KIT #184 1/4-WATT METAL FILM 150 for \$1.98</b> 100% metal film resistors. Long leads. BE3413	<b>BARREL KIT #182 JUNBO RED LEDS 15 for \$1.98</b> 100% material, user cancellation from factory dumps. 3V 10 mils. For 100's of projects, red lens. Cat. No. BE3369	<b>BARREL KIT #163 MINI TRIM POTS 30 for \$1.98</b> Asst. values 100 to 200K. What a buy! Single turn. 1/4 W. Wt. 6 oz. BE3345
<b>BARREL KIT #160 V. REGULATORS 10 for \$1.98</b> hobby LM300KC TO-3 V.R.'s barreled. Bot by the pound. No. BE3330	<b>BARREL KIT #159 MODULAR SWITCHES 25 for \$1.98</b> Centralab switches, TV-makers excess. Dpdt, 6pdt, etc. Brand new. Cat. No. BE3150	<b>BARREL KIT #154 CLOCK CHIPS 20 for \$1.98</b> hobby We gathered an assortment of clock chip, alarm, calendar, beepers, who knows, all mixed. Cat. No. BE3308	<b>BARREL KIT #145 MINI TRANSFORMER 15 for \$1.98</b> output, inter-stage and audio. Only 1 1/2" sq. Wt. 2 lbs. BE3294	<b>BARREL KIT #144 RCA PHONO PLUGS 40 for \$1.98</b> 1,000,000 RCA phono plugs for this one. You hi-fi-ers know what they are. 100% material. BE3293	<b>BARREL KIT #138 PANEL SWITCHES 30 for \$1.98</b> Did you hear of OAK? Another great maker barreled all types of rotary, electric, slides, etc. BE3268	<b>BARREL KIT #135 MICRO MINI LAMPS 20 for \$1.98</b> Imagine! Micro size (1/8 x 1/4") with wire leads. 1 to 5 VDC. 10 mils. BE3259
<b>BARREL KIT #128 MINI DIP ICs 100 for \$1.98</b> Large mfg dumped 100's of lths into barrels. Includes 741s, LM-080-8, 703, 667, 655, 658—but who knows? Wt. 1 lb. BE3245 hobby	<b>BARREL KIT #127 AXIAL ELECTROS 40 for \$1.98</b> Asst. capacities and voltages. Cat. No. BE3227	<b>BARREL KIT #126 UPRIGHT ELECTROS 40 for \$1.98</b> 1mf to 300mf in mixture of voltages. 100% marked 'n' good. BE3226	<b>BARREL KIT #115 MOLEX 100% GOOD SOCKETS 200 for \$1.98</b> good Calculator maker dump! We got a zillion of 'em. Cat. No. BE3147	<b>BARREL KIT #112 MICRO MINI LEDS 40 for \$1.98</b> hobby All the tiny leds, axial, up-right of Monsanto, Litronic, variety of colors. Yield 50% or better. BE3138	<b>BARREL KIT #109 TERMINAL STRIPS 100 for \$1.98</b> Wide asst. of terminal strip connectors, from 1 contact up. Strip manufacturers barrel dump in your gate. Wt. 1 lb. Cat. No. BE3136	<b>BARREL KIT #104 SLIDE VOLUME CONTROLS 10 for \$1.98</b> Cat. No. BE1057
<b>BARREL KIT #101 RESISTOR SPECIAL 200 for \$1.98</b> Includes: 1/4, 1/2, 1, 2-watters, carbon, 1/2 oz. 100% good. BE3054	<b>BARREL KIT #99 PHOTO ELECTRIC CELLS 20 for \$1.98</b> Asst. GE types, CDS types. Mixed by factory. Big job for us in separate. 100% good. Cat. No. BE3052	<b>BARREL KIT #93 HALF WATTERS 200 for \$1.98</b> Resistor factory tried to fool us by mixing 100% color-coded resistors in barrel. But value is there. 4 oz. BE3046 Untested	<b>BARREL #91 SILVER MICAS 100 for \$1.98</b> Axial, red case, variety of physical sizes & values. Cat. No. BE3018	<b>BARREL KIT #88 LITRONICS LED READOUTS 10 for \$1.98</b> Types 8000, 7400 series, HTL, ROMs, registers, clock & rate, 800s, 1000s, etc. Cat. No. BE2861	<b>BARREL KIT #87 NATIONAL IC BONAZON 100 for \$1.98</b> Types 8000, 7400 series, HTL, ROMs, registers, clock & rate, 800s, 1000s, etc. Cat. No. BE2860 Untested.	<b>BARREL KIT #86 HOBBY LEDS 40 for \$1.98</b> Wow! A Litronics dump of all kinds of mixed discrete LEDs. BE2859
<b>BARREL KIT #83 VOLT REG LM-340T 15 for \$1.98</b> Factory rejected them for length of leads. May include 6, 8, 12, 15, 18, 24 volts. Power tab. Cat. BE2635	<b>BARREL KIT #81 SUBMINI RESISTORS 200 for \$1.98</b> PC, upright type, color coded, 1/2 watt. Asst. values. Come in us in a barrel. Cat. No. BE2746 100% good	<b>BARREL KIT #76 1-WATT ZENERS 100 for \$1.98</b> Factory same as 400-mv's. Never-to-see-again offer. 6, 8, 10, 12, 15V. under glass. Double plug. Cat. No. BE2741 Untested.	<b>BARREL KIT #73 TRANSISTOR ELECTROS 50 for \$1.98</b> We don't wish to separate wide asst voltages & values up to 300 mf. Cat. BE2747	<b>BARREL KIT #71 CAPACITOR SPECIAL 100 pcs. \$1.98</b> micas, milleds, planatics, ceramics, discs, etc. Nifty 100% good Cat. No. BE2738	<b>BARREL KIT #68 2 WATTERS 100 for \$1.98</b> 100% good. Suppliers throw 'em in the barrel. It's a lil' gold mine. All marked. Cat. No. BE2735	<b>BARREL KIT #65 MIXED READOUTS 10 for \$1.98</b> Factory return—such numbers as MAN-4's, MAN-7's, MAN-3's, 11 barrels & no time to separate. Hobby. Cat. No. BE2733 Untested.
<b>BARREL KIT #74 POLYSTYRENE CAPS 100 for \$1.98</b> Finest caps made. As a sample we bought 10 barrels from factory, mixed values, all good. Cat. No. BE2729	<b>BARREL KIT #58 SLIDE SWITCHES 30 for \$1.98</b> All shapes, sizes, 1/2 and 1/4 momentaries, etc. Tremendous shop pak for 100's of switching projects. Cat. No. BE2726 100% good	<b>BARREL KIT #56 POWERS! POWERS! 100 for \$1.98</b> Cat. No. BE2724 Large distributor cleaned the house. Barrels of power resistors 3 to 7 watts.	<b>BARREL KIT #54 8 DIGIT READOUTS 10 for \$1.98</b> Bargain of a lifetime! All we got was 1 barrel—the "hisitor digit" types. Multi-bxed. Cat. No. BE2722	<b>BARREL KIT #40 PNP HIGH-POWER TRANSISTORS 20 for \$1.98</b> hobby Popular germanium TO-3 case BE2618 100% good	<b>BARREL KIT #39 2N3055 HOBBY TRANSISTORS 15 for \$1.98</b> Fallouts of the famous 2N4055. BE2617 100%	<b>BARREL KIT #36 GERMANIUM DIODES 200 for \$1.98</b> Cat. No. BE2614 Famous maker, popular item. Never grows old. Untested

## RCA VOM

Specifications  
Ranges—DC Voltage: 0 to 15, 150, and 1000 V; AC Voltage: 0 to 15, 150, and 1000 V. Direct Current: 0 to 150 mA; Resistance: 0 to 1K (measures 100 to 100 K Ω); Sensitivity—AC/DC: 1000 ohms-per-volt.  
Battery, for ohms function (not supplied)—one 1.5 V penlite (RCA V5034A or equiv.).  
Size and Weight—Dimensions: 3 1/2" in. (9 cm); 2 1/4" in. (6 cm); 1 1/4" in. (3.4 cm); Weight: 5 oz. (142g). Cat. No. BE3921

J.C. Penney's

## 8 TRACK TAPE TRANSPORT

\$995

- Shielded preamp
- 115VAC fan cooled motor
- Slides easily into modular cabinet

Special purchase from a famous USA maker of quality Hi-Fi systems for J.C. Penney's! Same unit as found in the most expensive home players. Plugs into any stereo amplifier! Excellent replacement unit or design your own high quality stereo tape system. Just insert an own high quality stereo tape. Operates automatically! 8-track cartridge and deck turns on automatically! 8-track cartridge and player shuts off automatically! Built-in program indicator lights, automatic and manual track selection. Ready to go, requires only external power supply! With output cables for amplifier and input cables for power supply. With instructions. Wt. 4 lbs. Size: 9 x 8 x 3 1/2". Cat. No. BE3101

## CB-HAM NOISE CANCELLING COMMUNICATIONS MIC

• UNIVERSAL! Fit virtually all rigs... everywhere.  
• Dynamic cartridge.

The answer to the biggest mobile communication problem—canceling automobile noise more effectively than power mikes. A must for 2 meter hams. Doesn't "trip" receiver. Low impedance, frequency response 300-5000 Hz, sensitivity—65db, 6-foot coiled cord, case made of hi-impact black plastic. With wiring instructions for 100's of CB's. Spt. wt. 2 lbs. BE3902

\$995

Cuts out noise of machinery, highway for clear transmission.

## 5 IN 1 PROJECT-ALL SLIDE PROJECTORS

\$1250

- Worth many times our asking price.
- Great for Light Shows, Strobes, Light Displays, Slide Projector!
- Wide angle focusing lens!

U.S. maker. Originally designed as a slide projector. Some may be modified for projecting a bin of lths. High quality 3 lens condensing system. Requires standard 100 watt projection bulb. 35mm slides can be inserted and removed manually. Heavy duty bicycle case, grey hammer-tone finish. Design your own low cost light show. Use a Xenon flash tube and make a strobe light. Many other uses too numerous to mention. Size: 11 x 3 1/2 x 4 1/2". Wt. 5 lbs. Cat. No. BE3870

<b>BARREL KIT #35 NEON LAMPS 30 for \$1.98</b> 100% good. Famous NE-2's. All prime, but factory made millions and barreled 'em. Your ad. Cat. No. BE2613	<b>BARREL KIT #31 METALLIC RESISTORS 100 for \$1.98</b> Made mostly by Corning, the finest resistor made. Mostly 1/2 watters, 1% to 5% tol. & a barrel of values. Cat. No. BE2609	<b>BARREL KIT #30 PREFORMED RESISTORS 200 for \$1.98</b> We got barrels of 1/4 and 1/2 watters for pc use. 100% 1/4, 100% 1/2 watters. No. BE2608 100% good
<b>BARREL KIT #27 REFORMED DISCS 150 for \$1.98</b> Hi-Fi mics shelf inventory but be dumped 'em in barrels. Perfomed, for PC use. Mixed values too! BE2605	<b>KIT #26 PLASTIC TRANSISTORS 100 for \$1.98</b> hobby Hi-Fi mics shelf inventory but be dumped 'em in barrels. Perfomed, for PC use. Mixed values too! BE2605	<b>BARREL KIT #25 METAL CAN TRANSISTORS 100 for \$1.98</b> Includes TO-5, TO-18, etc., assorted 2N number, unmarked etc. Cat. No. BE2603 Untested.
<b>BARREL KIT #20 LONG LEAD DISCS 100 for \$1.98</b> "auction sale" Prime, marked only Long leads. Cat. No. BE2598 100% good	<b>BARREL KIT #19 OIPPED MYLARS 60 for \$1.98</b> Finest capacitors made, shiny finish. Imagine factory dumping 'em in barrels. Cat. No. BE2597 100% good	<b>BARREL KIT #14 PRECISION RESISTORS 200 for \$1.98</b> Marked and unmarked 1/4, 1/2, 2 watters. No. BE2428
<b>BARREL KIT #11 POWER TAB TRANSISTORS 40 for \$1.98</b> NPN, plastic TO220 type. Assorted 2N numbers, 100% good. BE2425 Untested.	<b>BARREL KIT #10 ROMS-REGISTERS 75 for \$1.98</b> Untested Hobby 2K to 40 pin devices, marked, internal factory numbers, etc. Cat. No. BE2424	<b>BARREL KIT #8 SUBMINIATURE IF TRANSFORMERS 75 for \$1.98</b> Amazonia, includes 455kc, use, antenna, who knows? Cat. No. BE2422 100% good
<b>BARREL KIT #7 VOLUME CONTROL 30 for \$1.98</b> 100% good Singles, duals, variety of values, styles, big ones, small ones. Cat. No. BE2421	<b>BARREL KIT #5 SCRS, TRIACS, QUADRACS 40 for \$1.98</b> Raw factory stock, internal factory numbers, etc. Cat. No. BE2419 Untested.	<b>BARREL KIT #4 "4000" RECTIFIERS 100 for \$1.98</b> Untested, 1N1900 series. May include 400, 600, 800 and 1000 volters. BE2417
<b>BARREL KIT #3 1N4148/914 SWITCHING DIODES 100 for \$1.98</b> Imagine famous switching diodes at these prices! Cat. No. BE2418 Untested	<b>BARREL KIT #2 1N4148/914 SWITCHING DIODES 100 for \$1.98</b> Imagine famous switching diodes at these prices! Cat. No. BE2418 Untested	<b>BARREL KIT #1 5N7400 DIP IC'S. 75 for \$1.98</b> Marked 14 and/or with 16 pin dips, may include gates, registers, flip flops, counters. BE2415 Untest! Hobby

Terms: Add postage. Rated: net 30  
Phone: Wakefield, Mass. (617) 245-3829  
Retail: 16-18 Del Carmine St., Wakefield.

**POLY PAKS**  
P.O. BOX 942E LYNNFIELD, MA. 01940

SALE  
Send for FREE SUMMER CATALOG

C.O.D.'s MAY BE PHONED

### CRYSTALS

THESE FREQUENCIES ONLY

Part #	Frequency	Case Style	Price
CY1A	1.000 MHz	HC33U	\$5.95
CY2A	2.000 MHz	MC33U	\$5.95
CY2.01	2.010 MHz	HC33U	\$1.95
CY3A	4.000 MHz	HC18U	\$4.95
CY7A	5.000 MHz	HC18U	\$4.95
CY12A	10.000 MHz	HC18U	\$4.95
CY14A	14.31818 MHz	HC18U	\$4.95
CY19A	18.000 MHz	HC18U	\$4.95
CY22A	20.000 MHz	HC18U	\$4.95
CY30B	32.000 MHz	HC18U	\$4.95

XR-2206KB Kit \$29.95 Special XR-2206KA Kit \$19.95

### EXAR

WAVEFORM GENERATORS	XR-555CP	5 J9
XR-205	XR-320P	1.55
XR-2206CP	XR-556CP	1.85
XR-2207CP	XR-2240CP	3.25

MISCELLANEOUS

XR-2211CP	\$6.70	XR-2240CP	3.25
XR-4136	99	PHASE LOCKED LOOPS	
XR-1310CP	\$3.20	XR-210	5.20
XR-1310EP	3.20	XR-215	6.80
XR-1800P	3.20	XR-1489	4.90
XR-2567	2.99	XR-567CP	1.95
		XR-567CT	1.70

### CONNECTORS

#### PRINTED CIRCUIT EDGE-CARD

156 Spacing-Tin-Double Read-Out  
Bifurcated Contacts — Fits .054 to .070 P.C. Cards

Part #	Description	Price
15/30	PINS (Solder Eyelet)	\$1.95
18/36	PINS (Solder Eyelet)	\$2.49
22/44	PINS (Solder Eyelet)	\$2.95
50/100 (1.00 Spacing)	PINS (Solder Eyelet)	\$6.95

#### 25 PIN-D SUBMINATURE

Part #	Description	Price
DB25P	PLUG	\$3.25
DB25S	SOCKET	\$4.95

### IMC 3 1/2 DIGIT DVM KIT

This 0-2 VDC .05 per cent digital voltmeter features the Motorola 3 1/2 digit DVM chip set. It has a 4' LED display and operates from a single +5V power supply. The unit is provided complete with an injection molded black plastic case complete with Bezel. An optional power supply is available which fits into the same case as the 0-2V DVM allowing 117 VAC operation.

**A. 0-2V DVM with Case \$49.95**  
**B. 5V Power Supply \$14.95**

### Etching Kits

**32 X A-1** — P.C. Etch Materials Kit enough for 5 circuit boards \$29.95 ea.

**27 X A-1** — Etched Circuit Kit Complete kit — only add water \$ 9.95 ea.

**3662** — 6.5 X 4.5 X 1/16 Epoxy glass P-Pattern-44 P.C. Tabs-spaced 156" \$ 6.95 ea.

**8800V** — Universal Microcomputer/Processor plugboard — Epoxy Glass — complete with heatsink and mounting hardware 5.313 X 10 X 1/16 copper clad \$19.95 ea.

### 1/16 VECTOR BOARD

Part #	Hole Spacing	P-Pattern	Price
PHENOLIC			
64P44 062A33P	4.50	6.50	1.72 1.52
169P44 02A33P	4.50	11.00	3.69 3.32
64P44 062	4.50	6.50	2.01 1.86
84P44 062	4.50	8.00	2.56 2.31
169P44 062	4.50	17.00	5.04 4.53
169P44 062	8.50	17.00	9.23 8.26
169P44 062C1	4.50	11.00	6.80 6.12

### HEAT SINKS

Part #	Description	Price
205CB	Beryllium Copper Heat Sink with Black Finish for TO-5	\$ 25
291-36H	Aluminum Heat Sink for TO-220 Transistors & Regulators	\$ 25
680-75A	Black Anodized Aluminum Fan TO-3	\$1.60

### HEXADECIMAL ENCODER 19-KEY PAD

- 1 0
- ABCDEF
- Return Key
- Optional Key (Period)
- Key

**\$10.95 each**

### 60 KEY KEYBOARD

This keyboard features 60 unenclosed SPST keys, unattached to any kind of P.C.B. A very solid molded plastic 13" x 4" base suits most applications.

**\$19.95**

HD0615 16 LINE TO FOUR BIT PARALLEL KEYBOARD ENCODER \$7.95

### TOOLS

A97MS	Diagonal Cutter - 4" semi-flush cut	\$8.50 ea.
A11DMS	Chain Nose Pliers - 4 1/2" long	7.50 ea.
T-6	Wire Stripper - #16 to #26 gauge	3.75 ea.
55B	Wire Stripper - #10 to #20 gauge	2.50 ea.
CS-8	Cutter-Crimper Tool - 8 1/4" long	8.50 ea.
Nipping Tool	Cuts, Trims or Notches Metal up to #18 gauge	6.95 ea.
Nibbling Tool	Replacement Punch	3.75 ea.

**PERMACEL™ P-29 PLUS** Electrical Tape - All Weather  
1/2" wide x 56 Ft. Black Vinyl  
1-9 Rolls \$7.99 each 10 up Rolls \$7.95/10 roll package

### MICROPROCESSOR COMPONENTS

8080A CPU	\$19.95	8228 System Controller - Bus Driver	\$10.95
8212 8 Bit Input/Output	4.95	MC6800L 8 Bit MPU	35.00
8214 Priority Interrupt Control	15.95	MC6820L Periph. Interface Adapter	15.00
8216 Bi-Directional Bus Driver	6.95	MC681DAP1 128 x 8 Bit Static RAM	6.00
8224 Clock Generator/Driver	10.95	MC6830L8 1024 x 8 Bit ROM	18.00
CDP1802 - with user manual	39.95	Z80 CPU	49.95

8080 Super 8008 24.95 1101 256 x 1 Static 5.95  
8080A Super 8008 19.95 2101 256 x 4 Static 5.19  
2650 8 Bit MPU 26.50 2102 1024 x 1 Static 1.75  
2107-5280 4096 x 1 Dynamic 4.95  
2111 789 256 x 1 Static 6.95  
1024 Dynamic 2.95  
1024 16 x 4 Static 1.75  
8101 256 x 4 Static 6.95  
8111 256 x 4 Static 6.95  
8113 16 x 4 Static 3.99  
91102 1024 x 1 Static 7.95  
74200 256 x 1 Static 2.25  
93421 256 x 1 Static 2.95  
Special \$ 9.95 MM5276 2K x 1 Dynamic 2 for 1.00

AV-5-1013 30K BAUD \$5.95

2513(2140) Char Gen-upper case \$ 9.95  
2513(3021) Char Gen-lower case 9.95  
2516 Char Gen 10.95

### SPECIAL REQUESTED ITEMS

FCM3817 \$ 5.00	6.75 825115 25.00 8T97 2.00
AY-3 8500-1 \$16.95	6.50 5841 9.95 9368 6.95
MC3061P 3.50	CD4508 17.50 MC1481B7 9.95
MC4016P (74418) 7.50	CO4515 6.50 5841 9.95
MC14583 3.50	CD4520 2.70 MC30240 17.50
MC14582 14.50	CMC6574 17.50 11C90 19.95
CD4059 9.50	CMC6574 17.50 150079CH 3.75
CD4070 14.95	MC66575 17.50 TL3208 10.50
MC14409 14.95	MC14419 14.95 ICM7015 24.95
MC14410 14.95	ICM7015 24.95 ICM7207 7.50

### PARATRONICS

ALLOW 1 TO 3 WEEKS DELIVERY

#### Logic Analyzer Kit MODEL 100A \$189.00/Kit

- Analyzes any type of digital system
- Checks data rates in excess of 8 million words per second
- Trouble shoot TTL, CMOS, DTL, RTL, Schottky and MOS families
- Displays 16 logic states up to 8 digits wide
- See ones and zeros displayed on your CRT, octal or hexadecimal format
- Tests circuits under actual operating conditions
- Easy to assemble — comes with step-by-step construction manual which includes 80 pages on logic analyzer operation.

Some applications are:

- Troubleshooting microprocessor address, instruction, and data flow
- Examine contents of ROMS
- Tracing operation of control logic
- Checking counter and shift register operation
- Monitoring I/O sequences
- Verifying proper system operations during testing

### BUGBOOK

Continuing Education Series

**BUGBOOK I & II** — Basic concepts of TTL Logic — over 90 experiments \$17.00/set

**BUGBOOK IIa** — Introduces UART — recommended for RTTY enthusiasts \$5.00/book

**BUGBOOK III** — Explores 8080 chip — introduces Mark 80 Microcomputer \$15.00/book

**555 TIMER APPLICATIONS SOURCEBOOK WITH EXPERIMENTS** — over 100 design techniques \$6.95/book

**CMOS-M-DESIGNERS PRIMER AND HANDBOOK** a complete CMOS instruction manual \$6.00

Introductory Offer — all 6 books (worth \$49.95) SPECIAL — \$42.95

### CONTINENTAL SPECIALTIES

PROTO BOARD 6 \$15.95 (6" long X 4" wide)	Other CS Proto Boards	PROTO CLIPS
PB100 - 4.5" x 6"	\$ 19.95	14 PIN \$4.50
PB101 - 5.8" x 4.5"	29.95	16 PIN 4.75
PB102 - 7" x 4.5"	39.95	24 PIN 8.50
PB103 - 9" x 6"	59.95	
PB104 - 9.5" x 8"	79.95	
PB203 - 9.75 x 6 1/2 x 2 1/2	75.00	
PB203A - 9.75 x 6 1/2 x 2 1/2	120.00 (includes power supply)	

Logic Monitor for DTL, TTL, HTL or CMOS Devices \$84.95

### QT PROTO STRIPS

Part #	Price	#holes	price
QT-59S	12.50	590	12.50
QT-59B	7.50	590	7.50
QT-47S	4.75	470	10.00
QT-47B	2.25	470	2.25
QT-35S	8.50	350	8.50
QT-35B	2.00	350	2.00
QT-18S	4.75	180	4.75
QT-12S	3.75	120	3.75
QT-8S	3.25	80	3.25
QT-7S	3.00	70	3.00

Experimenter 300 \$ 9.95  
Experimenter 600 \$10.95

\$5.00 Minimum Order — U.S. Funds Only  
California Residents — Add 6% Sales Tax

Spec Sheets - 25¢ — Send 35¢ Stamp for 1977A Catalog  
Dealer Discount Available — Request Pricing

### James ELECTRONICS

1021-A HOWARD AVE., SAN CARLOS, CA. 94070  
PHONE ORDERS WELCOME — (415) 592-8097  
All Advertised Prices Good Thru August

**NOW OPEN SATURDAYS**

### Timeband

A Division of Electronic Camera and Instrument Corporation

#### Digital Alarm Clocks

24-hour alarm  
Door Button  
100% Silent Slats  
Large Red LED Display  
1.8 High Light  
AM/PM Indicator  
Seconds display at touch of button  
C-500B - Ebony Case  
One Year factory warranty

C-500 - Ivory Case \$16.95  
C-8211 Woodgrain Case \$19.95

### DIGITAL AUTO INSTRUMENT

SEVEN DIFFERENT INSTRUMENTS MEETS OR EXCEEDS ORIGINAL AUTOMOTIVE SPECS

Please specify which one of the seven models you want when ordering — these do not come in one unit. Each model must be bought separately.

TACHOMETER 0-9000 RPM 4, 6 or 8 Cylinders	SPEEDOMETER 0-99 MPH
WATER TEMP 100-250° F	OIL PRESSURE 0-80 PSI
FUEL LEVEL 3 Percentage Low Fuel Indicator	OIL TEMP 200-350° F
	BATTERY MONITOR ±1 Volts From 11-15 VDC

BRIGHT YELLOW ORANGE 3' LED DISPLAY!  
KIT includes case, bracket and all components — complete.  
Nothing else to buy! 12 Volt-NEG GND.  
DIMENSIONS: 4 1/2 x 4 x 2 KIT: \$49.95  
Add \$10.00 for required speed transducer. ASSEMBLED: \$59.95

### DIGITAL STOPWATCH

- Bright 6 Digit LED Display
- Times to 59 minutes 59.99 seconds
- Crystal Controlled Time Base
- Three Stopwatches in One
- Times Single Event — Split & Taylor
- Size 4.5" x 2.15" x .90" (4 1/2" ounces)
- Uses 3 Pennie Cells.

Kit — \$39.95  
Assembled — \$49.95  
Heavy Duty Carry Case \$5.95

Stop Watch Chip Only (7205) \$19.95

### AUTOTEL

An audible alarm kit indicating potential engine damage. An audible signal (70 db putting) immediately forewarns a malfunction or failure. There is no sound during normal operation. Features CMOS circuitry. 2 1/2" x 2 1/2" x 3/8" case. Complete kit with all components, hardware and case.

**SPECIAL \$6.95/Kit**

### QUARTZ DIGITAL AUTO CLOCK OR ELAPSED TIMER!

Elapsed Timer: Hrs, Mins and Secs  
12 or 24 Hr Capacity  
Simple Reset - Start Pushbutton Control

Complete kit includes mounting bracket, case and all components, nothing else to buy. Features MMS314 chip, Large 4 LED's. Accuracy better than ± min. per mo. internal battery backup. 12 volt non-polar operation.

DIMENSIONS 4 1/2" x 4 x 2"  
12 or 24 HOUR MODE

Kit: \$29.95  
Assembled: \$39.95

**CASE ONLY (includes hardware, mounting bracket and bezel) \$6.50**

### JE700 CLOCK

The JE700 is a low cost digital clock, but it's a very high quality unit. The unit features a simulated walnut case with dimensions of 6 x 2 1/2 x 1. It utilizes a MAM72 high brightness red/white and the MMS314 clock chip.

12 or 24 Hour  
115 VAC  
**\$17.95**

### DIGITAL CLOCK KIT — 3 1/2" INCH DIGITS

4 DIGIT KIT \$49.95 4 DIGIT ASSEMBLED \$59.95  
6 DIGIT KIT \$69.95 6 DIGIT ASSEMBLED \$79.95

This clock features big 3 1/2" high digits for viewing in offices, auditoriums, etc. Each digit is formed by 31 bright 0.2" LED's. The clock operates from 117 VAC, has either 12 or 24 hr. operation. The 6 digit version is 27" x 3 1/2" x 1 1/2" and the 4 digit is 18" x 3 1/2" x 1 1/2". Kits come complete with all components, case and transformer.  
Specify 12 or 24 Hour When Ordering

### JE803 PROBE

The Logic Probe is a unit which is for the most part indispensable in trouble shooting logic families. TTL, DTL, RTL, CMOS. It derives the power it needs to operate directly off of the circuit under test, drawing a scant 10 mA max. It uses 3 MAND readout to indicate any of the following states by these symbols: (H) 1 (LOW) 0 (PULSE) P. The Probe can detect high frequency pulses to 45 MHz. It can be used at MOS levels or circuit damage will result.

Experimenter 300 \$ 9.95  
Experimenter 600 \$10.95

**\$9.95 Per Kit**  
printed circuit board

**T<sup>2</sup>L 5V 1A Supply**  
This is a standard TTL power supply using the well known LM309K regulator IC to provide a solid 1 AMP of current at 5 volts. We try to make things easy for you by providing everything you need in one package, including the hardware for only

**\$9.95 Per Kit**

### 7400N TTL

SN7400N	16	SN7455A	25	SN74154N	1.00
SN7401N	16	SN7460N	22	SN74155N	99
SN7402N	21	SN7470N	45	SN74156N	99
SN7403N	16	SN7472N	39	SN74157N	99
SN7404N	18	SN7473N	27	SN74160N	1.25
SN7405A	24	SN7474N	32	SN74161N	99
SN7406N	20	SN7475N	50	SN74162N	1.25
SN7407N	29	SN7476N	32	SN74163N	99
SN7408N	25	SN7477N	5.00	SN74164N	1.10
SN7409N	25	SN7478N	50	SN74165N	1.10
SN7410N	18	SN7482N	90	SN74166N	1.25
SN7411N	30	SN7483N	70	SN74167N	5.50
SN7412N	33	SN7485N	99	SN74170N	2.10
SN7413N	45	SN7486N	39	SN74172N	8.95
SN7414N	70	SN7488N	3.50	SN74173N	1.50
SN7415N	35	SN7489N	2.49	SN74174N	1.25
SN7417N	35	SN7490N	45	SN74175N	99
SN7420N	21	SN7492N	49	SN74177N	90
SN7421N	33	SN7493N	49	SN74180N	99
SN7422N	49	SN7494N	79	SN74181N	2.49
SN7423N	37	SN7495N	79	SN74182N	99
SN7425N	29	SN7497N	4.00	SN74184N	1.95
SN7427N	37	SN7497N	4.00	SN74185A	2.00
SN7429N	42	SN74100N	1.00	SN74186N	1.25
SN7430N	25	SN74107N	39	SN74187N	6.10
SN7432N	21	SN74121N	39	SN74188N	1.00
SN7437N	29	SN74122N	39	SN74190N	1.00
SN7438N	27	SN74123N	50	SN74191N	1.25
SN7439N	25	SN74125N	60	SN74192N	89
SN7440N	15	SN74126N	60	SN74193N	89
SN7441N	89	SN74127N	99	SN74194N	1.75
SN7442N	59	SN74136N	95	SN74195N	75
SN7443N	75	SN74141N	1.15	SN74196N	1.25
SN7444N	75	SN74142N	4.00	SN74197N	75
SN7445N	75	SN74143N	4.50	SN74198N	1.75
SN7446N	61	SN74144N	5.00	SN74199N	1.75
SN7447N	89	SN74145N	1.15	SN74200N	5.59
SN7448N	79	SN74147N	2.35	SN74209N	90
SN7450N	26	SN74148N	2.00	SN74251N	1.79
SN7451N	27	SN74150N	1.00	SN74252N	6.00
SN7453N	27	SN74151N	.79	SN74285N	6.00
SN7454N	20	SN74153N	89	SN74307N	7.50

### Timeband by FAIRCHILD Watches

Men's & Ladies

- Solid State
- Displays hour, minute, second, month & day
- Snap-out battery replacement
- Free set of replacement batteries
- Choose LED or LCD styles
- One year factory warranty

T201 Black Braconet LED \$19.95  
T231 White w/bracelet \$29.95  
T236 Yellow w/bracelet \$34.95 LED

### CHANNEL F

FAIRCHILD VIDEO ENTERTAINMENT SYSTEM

Freeze Action • Speed Option  
Automatic time and scenekeeping  
Battery-Free AC operation  
Dual controls with 8-way action  
Built-in Pro Hockey and Tennis games  
Easy hook-up on any B/W or Color TV  
Factory warranty

Channel F — additional cartridges — \$19.95 ea.  
#8112 - Desert Fox/Shooting Gallery  
#8113 - BlackJack (1 or 2 players)  
#8114 - Spiffire (1 or 2 players)  
#8115 - Space War  
#8111 - Tic-Tac-Toe/Shooting Gallery/Doodle/Quadra-Doodle

### WIRE WRAP CENTER

HOBBY-WRAP TOOL-BW-630

- Battery Operated (Size C)
- Weights ONLY 11 Ounces
- Wraps 30 AWG Wire onto Standard DIP Sockets (.025 inch)
- Complete with built-in bit and sleeve

\$34.95 (batteries not included)

### WIRE-WRAP KIT — WK-2-W

WRAP • STRIP • UNWRAP

- Tool for 30 AWG Wire
- Roll of 50 Ft. White or Blue 30 AWG Wire
- 50 pcs. each 1", 2", 3" & 4" lengths — pre-stripped wire.

\$11.95

### WIRE WRAP TOOL WSU-30

WRAP • STRIP • UNWRAP — \$5.95

### WIRE WRAP KIT — 30 AWG

25 ft. min. \$1.25 50ft. \$1.95 100ft. \$2.95 1000ft. \$15.00  
SPECIFY COLOR — White - Yellow - Red - Green - Blue - Black

### Plastic Push Button Switch

- 18 AWG Solid Wire - 5" Long
- 50 (wide) X .80 (high) ¼-27 Thread
- 8 AMP at 14 Volt - 1 AMP at 10 Volt

J-188-1	Push On-Push Off	1.9	10-Up
J-188-2	Normally Open	.59	49
J-188-3	Normally Closed	.59	49

### CMOS

20% Discount for 100 Combined 7400's

CD4000	25	CD4000	55	74C04N	75
CD4001	25	CD4030	1.85	74C10N	65
CD4002	25	CD4035	1.85	74C20N	65
CD4006	2.50	CD4040	2.45	74C20N	65
CD4007	25	CD4042	1.80	74C20N	2.15
CD4009	59	CD4044	1.50	74C23N	1.50
CD4010	59	CD4046	2.51	74C74	1.15
CD4011	25	CD4047	2.75	74C90N	3.00
CD4012	25	CD4049	79	74C95N	1.25
CD4013	47	CD4050	79	74C107N	1.25
CD4016	56	CD4051	2.95	74C151	2.90
CD4017	1.35	CD4052	2.95	74C154	4.00
CD4019	55	CD4060	3.25	74C157	2.15
CD4020	48	CD4061	1.75	74C158	2.15
CD4022	1.25	CD4069	45	74C161	3.25
CD4023	25	CD4071	45	74C163	3.00
CD4024	1.50	CD4081	45	74C164	3.25
CD4025	25	CD4511	1.75	74C173	2.60
CD4026	\$3.95	CD4512	2.50	74C193	2.75
CD4027	69	MC1456B	3.00	74C195	2.75
CD4028	1.65	74C00N	39	MC1444	4.50
CD4029	2.90	74C02N	55	MC14016	56

### DISCRETE LEDs

KC209	Red	10.51	KC111	Red	10.51
KC209	Green	4.81	KC111	Green	4.81
KC209	Orange	4.81	KC111	Yellow	4.81
KC209	Yellow	4.81	KC111	Orange	4.81

### DISPLAY LEDs

KC22	Red	10.51	KC526	Red	5.51
KC22	Green	4.81	KC526	Green	4.81
KC22	Yellow	4.81	KC526	Yellow	4.81
KC22	Orange	4.81	KC526	Orange	4.81
SSL-22	RT	4.81	KC526	Clear	4.81

### FCS 8000A — 3 1/2 Digit — 8" Display

NEW! 25 Pin Version with color & bump indicator

- Connects almost one for one with 8117, 8171A or D. 13817 available at \$5.00 each.
- Typical segment current 8mA except color. 10, 15, 20, 25, 30, 35, 40, 45, 50, 55, 60, 65, 70, 75, 80, 85, 90, 95, 100 mA.
- Forward voltage drop 1.5 volts.

\$4.95 EA.

### HP 5082-7300 Multi-Digit Series

- 1/2" Ht. • Common Cathode • D/p Package
- 3 to 5 to 15's @ 5 mils per segment
- 7 segment Monolithic • Red Display

2 Digit	\$ .79
3 Digit	.99
4 Digit	1.29
5 Digit	1.59

### IC SOLDERTAL — LOW PROFILE (TIN) SOCKETS

8 pin	1.24	25-49	50-100
14 pin	2.24	25-49	50-100
16 pin	3.24	25-49	50-100
20 pin	4.24	25-49	50-100
24 pin	5.24	25-49	50-100
28 pin	6.24	25-49	50-100
32 pin	7.24	25-49	50-100
36 pin	8.24	25-49	50-100
40 pin	9.24	25-49	50-100

### 50 PCS. RESISTOR ASSORTMENTS \$1.25 PER ASST.

ASST. 1 5 ea. 20 0HM 12 0HM 15 0HM 18 0HM 22 0HM  
ASST. 2 5 ea. 27 0HM 33 0HM 39 0HM 47 0HM 56 0HM  
ASST. 3 5 ea. 68 0HM 82 0HM 100 0HM 120 0HM 150 0HM  
ASST. 4 5 ea. 180 0HM 220 0HM 270 0HM 330 0HM 390 0HM  
ASST. 5 5 ea. 470 0HM 560 0HM 680 0HM 820 0HM 1K  
ASST. 6 5 ea. 1.2K 1.5K 1.8K 2.2K 2.7K  
ASST. 7 5 ea. 3.3K 3.9K 4.7K 5.6K 6.8K  
ASST. 8 5 ea. 8.2K 10K 12K 15K 18K  
ASST. 9 5 ea. 22K 27K 33K 39K 47K  
ASST. 10 5 ea. 56K 68K 82K 100K 120K  
ASST. 11 5 ea. 150K 180K 220K 270K 330K  
ASST. 12 5 ea. 390K 470K 560K 680K 820K  
ASST. 13 5 ea. 1M 1.2M 1.5M 1.8M 2.2M  
ASST. 14 5 ea. 2.7M 3.3M 3.9M 4.7M 5.6M

\$5.00 Minimum Order — U.S. Funds Only  
California Residents — Add 8% Sales Tax  
Spec Sheets - 25c — Send 35c Stamp for 1977A Catalog  
Dealer Discount Available — Request Pricing

### DIP SWITCHES

SPST Slide Action

- #206-4 (8 pin dip) 4 switch unit \$1.75 ea.
- #206-7 (14 pin dip) 7 switch unit \$1.95 ea.
- #206-8 (16 pin dip) 8 switch unit \$2.25 ea.

### TV GAME CHIP SET — \$14.95

Includes AY-3-8500-1 chip and 2.010 mhz crystal — if purchased separately would cost \$18.95

### ZENERS — DIODES — RECTIFIERS

TYPE	VOLTS V	W	PRICE	TYPE	VOLTS V	W	PRICE
1N746	3.3	400m	4/10	1N4001	50	1000 PIV	1.00
1N751	5.1	400m	4/10	1N4002	50	1000 PIV	1.00
1N752	5.6	400m	4/10	1N4004	50	1000 PIV	1.00
1N753	6.2	400m	4/10	1N4006	50	200m	6/10
1N754	6.8	400m	4/10	1N4735	6.2	1w	10/10
1N759	8.2	400m	4/10	1N4736	6.2	1w	10/10
1N965E	15	400m	4/10	1N4737	6.2	1w	28
1N5232	5.6	500m	28	1N4738	5.6	1w	28
1N5235	6.8	500m	28	1N4739	6.8	1w	28
1N5236	7.5	500m	28	1N4740	7.5	1w	28
1N4526	25	40m	6/10	1N4742	12	1w	28
1N4528	150	7m	6/10	1N4744	15	1w	28
1N4529	150	10m	6/10	1N1183	50	35 PIV	3.50
1N4530	150	10m	6/10	1N1184	100	35 PIV	1.70
1N4531	150	10m	6/10	1N1185	150	35 PIV	1.70
1N4532	150	10m	6/10	1N1186	200	35 PIV	1.80
1N4533	150	10m	6/10	1N1188	400	35 PIV	3.00

### SCR AND FW BRIDGE RECTIFIERS

C3ED	15A @ 400V	SCR	\$1.95
C3EM	35A @ 200V	SCR	1.95
C3EN	1.6A @ 200V	SCR	.50
MDA 380-1	12A @ 50V	FW BRIDGE REC.	1.95
MDA 380-3	12A @ 200V	FW BRIDGE REC.	1.95

### TRANSISTORS

2N3638	351.00	2N4219	4.51.00
2N3639	451.00	2N4220	4.51.00
2N3640	451.00	2N4221	4.51.00
2N3641	451.00	2N4222	4.51.00
2N3642	451.00	2N4223	4.51.00
2N3643	451.00	2N4224	4.51.00
2N3644	451.00	2N4225	4.51.00
2N3645	451.00	2N4226	4.51.00
2N3646	451.00	2N4227	4.51.00
2N3647	451.00	2N4228	4.51.00
2N3648	451.00	2N4229	4.51.00
2N3649	451.00	2N4230	4.51.00
2N3650	451.00	2N4231	4.51.00
2N3651	451.00	2N4232	4.51.00
2N3652	451.00	2N4233	4.51.00
2N3653	451.00	2N4234	4.51.00
2N3654	451.00	2N4235	4.51.00
2N3655	451.00	2N4236	4.51.00
2N3656	451.00	2N4237	4.51.00
2N3657	451.00	2N4238	4.51.00
2N3658	451.00	2N4239	4.51.00
2N3659	451.00	2N4240	4.51.00
2N3660	451.00	2N4241	4.51.00
2N3661	451.00	2N4242	4.51.00
2N3662	451.00	2N4243	4.51.00
2N3663	451.00	2N4244	4.51.00
2N3664	451.00	2N4245	4.51.00
2N3665	451.00	2N4246	4.51.00
2N3666	451.00	2N4247	4.51.00
2N3667	451.00	2N4248	4.51.00
2N3668	451.00	2N4249	4.51.00
2N3669	451.00	2N4250	4.51.00
2N3670	451.00	2N4251	4.51.00
2N3671	451.00	2N4252	4.51.00
2N3672	451.00	2N4253	4.51.00
2N3673	451.00	2N4254	4.51.00
2N3674	451.00	2N4255	4.51.00
2N3675	451.00	2N4256	4.51.00
2N3676	451.00	2N4257	4.51.00
2N3677	451.00	2N4258	4.51.00
2N3678	451.00	2N4259	4.51.00
2N3679	451.00	2N4260	4.51.00
2N3680	451.00	2N4261	4.51.00
2N3681	451.00	2N4262	4.51.00
2N3682	451.00	2N4263	4.51.00
2N3683	451.00	2N4264	4.51.00
2N3684	451.00	2N4265	4.51.00
2N3685	451.00	2N4266	4.51.00
2N3686	451.00	2N4267	4.51.00
2N3687	451.00	2N4268	4.51.00
2N3688	451.00	2N4269	4.51.00
2N3689	451.00	2N4270	4.51.00
2N3690	451.00	2N4271	4.51.00
2N3691	451.00	2N4272	4.51.00
2N3692	451.00	2N4273	4.51.00
2N3693	451.00	2N4274	4.51.00
2N3694	451.00	2N4275	4.51.00
2N3695	451.00	2N4276	4.51.00
2N3696	451.00	2N4277	4.51.00
2N3697	451.00	2N4278	4.51.00
2N3698	451.00	2N4279	



## ABOUT YOUR SUBSCRIPTION

Your subscription to POPULAR ELECTRONICS is maintained on one of the world's most modern, efficient computer systems, and if you're like 99% of our subscribers, you'll never have any reason to complain about your subscription service.

We have found that when complaints do arise, the majority of them occur because people have written their names or addresses differently at different times. For example, if your subscription were listed under "William Jones, Cedar Lane, Middletown, Arizona," and you were to renew it as "Bill Jones, Cedar Lane, Middletown, Arizona," our computer would think that two separate subscriptions were involved, and it would start sending you two copies of POPULAR ELECTRONICS each month. Other examples of combinations of names that would confuse the computer would include: John Henry Smith and Henry Smith; and Mrs. Joseph Jones and Mary Jones. Minor differences in addresses can also lead to difficulties. For example, to the computer, 100 Second St. is not the same as 100 2nd St.

So, please, when you write us about your subscription, be sure to enclose the mailing label from the cover of the magazine—or else copy your name and address exactly as they appear on the mailing label. This will greatly reduce any chance of error, and we will be able to service your request much more quickly.

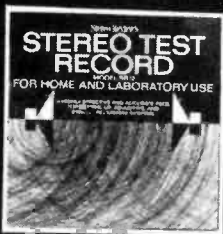

Announcing the **NEW STANDARD**  
in Stereo Testing!

## The All-New Model SR12 STEREO TEST RECORD

The most complete... most sophisticated...  
most versatile Test Disc available today... **For Just \$6.95!**

Whether you're an avid audiophile, a casual listener or a professional technician... the new MODEL SR12 will be the most important disc in your entire collection.

MODEL SR12 has been produced by Stereo Review Magazine for music lovers who want immediate answers to questions about the performance of their stereo systems and how to get the best possible sound reproduction.

It is the most complete test record of its kind — containing the widest range of checks ever included on one test disc.

Make these important stereo checks **BY EAR...**  
(no test instruments required)

- ▶ Frequency response—a direct warble-tone check of nineteen sections of the frequency spectrum, from 20 to 20,840 Hz, which will pinpoint any frequency response defects in your system.
- ▶ Separation—an ingenious test which indicates whether you have adequate separation for good stereo.
- ▶ Cartridge tracking—the most sophisticated tests ever devised for checking the performance of your cartridge, stylus and tone arm.
- ▶ Channel balance—two broad-band, random-noise signals which permit you to eliminate any imbalances originating in cartridge, amplifier, speakers or room acoustics.
- ▶ Hum and rumble—foolproof tests that help you evaluate the actual audible levels of rumble and hum in your system.
- ▶ Flutter—a sensitive "musical" test to check whether your turntable's flutter is low, moderate, or high.

**PLUS!** ● Cartridge and Speaker Phasing ● Anti-Skating Adjustment ● "Gun Shot Test" for Stereo Spread ● Multi-purpose Musician's "A" ● Equal-tempered Chromatic Octave ● Guitar-tuning Tones.

**Attention Professionals** . . . . . Model SR12 is also designed to be used as a highly efficient design and measurement tool. Tests below have been controlled to laboratory tolerances—affording accurate numerical evaluation when used with oscilloscope, chart recorder, output meter, intermodulation-distortion meter and flutter meter.

- 1,000-Hz square waves to test transient and high-frequency response of phono pickups.
- 500 to 20,000 Hz frequency-response sweep.
- Sine-wave tone-bursts to test transient response of pickup.
- Intermodulation test using simultaneous 400-Hz and 4,000-Hz signals.
- Intermodulation sweep to show distortion caused by excessive resonances in tone arm and cartridge.
- 1,000-Hz reference tones to determine groove velocity.
- 3,000-Hz tone for flutter and speed tests.

Sample waveforms—illustrating both accurate and faulty responses are provided in the Instruction Manual for comparison with the patterns appearing on your own oscilloscope screen.

**FREE** —  
An informative manual which includes charts, tables and diagrams.

CHARGE YOUR ORDER TO  
YOUR AMERICAN EXPRESS,  
BANKAMERICARD,  
MASTER CHARGE OR  
DINERS CLUB ACCOUNT.



Ziff-Davis Service Div., Dept. R, 595 B'way, N.Y., N.Y. 10012. PE-87  
 Please send the SR12 Stereo Test Record @ \$6.95, postpaid (\$8.95 outside U.S.A.).

Enclosed is \$\_\_\_\_\_ (Residents of Calif., Col., Fla., Ill., Mich., Mo., N.Y. State, D.C. and Tex. add applicable sales tax.)

CHARGE:  American Express  Master Charge  
 BankAmericard  Diners Club

Account # \_\_\_\_\_ Exp. Date \_\_\_\_\_  
Master Charge Interbank # \_\_\_\_\_ (4 numbers over your name)

Signature \_\_\_\_\_

Print Name \_\_\_\_\_

Address \_\_\_\_\_

City \_\_\_\_\_ State \_\_\_\_\_ Zip \_\_\_\_\_

**RADAR DETECTOR KIT.** Build a long range radar detector with over one mile range. Kit comes with complete documentation and drilled, etched and plated PC board. Only \$4.95. Thousands sold nationally. Satisfaction guaranteed. Same day shipment. J.B. Saunders Company, 3050 Valmont, Boulder, Colorado 80301.

**PROFESSIONAL UNSCRAMBLERS** — several models that fit any scanner. Free information. Capri Electronics, 8753T Windom, St. Louis, MO 63114.

**UNSCRAMBLE CODED MESSAGES** from Police, Fire and Medical Channels. Same day service. Satisfaction guaranteed. Don Nobles Electronics, Inc., Rt. 7, Box 265B, Hot Springs, Arkansas 71901. (501) 623-6027.

**ANYTHING ELECTRONIC** — we've got it. Catalog \$1.00. Razo, Box 1224, Cupertino, Calif.

**BUILD YOUR OWN TV CAMERA!**  
— Ideal for home & business —



THE ECONOMIC ANSWER TO HOME MONITORING OF NURSERIES, ENTRANCES, DRIVEWAYS, BUSINESS and INDUSTRIAL SURVEILLANCE... IT'S AN AMATEUR TV PLUS HUNDREDS OF OTHER APPLICATIONS. MODEL XT-1A, SERIES D — KIT FORM \$185; ASSEMBLED \$275. SOLID-STATE. WORKS ON ANY TV SET. OPTIONAL SOUND KIT \$28.95. PHONE OR WRITE for catalog. Dial 402-981-3111

1301 BROADWAY **ATV Research** DAKOTA CITY, NE. 68731

**NEGATIVE ION Generator.** \$275.00. Complete kit \$165.00. Construction plans \$10.00. Golden Enterprises, Box 1282PE, Glendale, Arizona 85311.

**UNBELIEVABLE Goldmine of Electronic Schematics.** Over 200. Useful, Novel, and Amazing Projects. Only \$9.99! Money Back Guarantee. Send for Free project list. Space-tech, Box 182, Gillette, N.J. 07933.

**USED TEST EQUIPMENT** — Tektronix, HP, GR. Write: PTI, Box 8699, White Bear Lake, MN 55110. Phone: (612) 429-2975.

**PRINTED CIRCUITS.** Pint photo resist with aerosol \$15.25. Quart developer \$5.60. Four packs dry etchant \$5.56. Pint tin plating solution \$6.50. 8x10 auto lock exposure frame \$11.50. Ultraviolet lamp \$16. Shipping prepaid. CIR-COLEX, Box 198, Marcy, N.Y. 13403.

**DETECT/DESTROY hidden "bugs", wiretaps.** Complete line countersurveillance equipment. Golden Enterprises, Box 1282-PE, Glendale, Arizona 85311.

**PRINTED CIRCUIT BOARDS** from artwork, magazine layouts. Fast service. Information send stamped envelope. OMEGA ENTERPRISES, Box 48239, Niles, Ill. 60648.

**SURPLUS Relays, 90° drives, equipment** — more. List. Olive Branch Sales, P.O. Box 191P, Fairmont, Illinois 61841.

**PROMS programmed inexpensively.** See display ad July Popular Electronics. RBH Enterprises, Box 12344, Wichita, Kansas 67277.

**DEAD BATTERY? LIGHTS, LEFT ON? Alarm alerts driver with pulsing tone.** Easy installation, \$12.95. Postpaid. CFL Enterprises, Box 415, Export, PA 15432.

**IT'S HERE!** **PHONE TONE ENCODER with KEYPAD**

- Converts rotary dial telephone into a tone telephone.
- Can be used stand alone for tone operated equipment.
- Feather-light touch to activate.
- Use your finger, thumb or even your big toe for touching numbers.
- Millions of applications—access computers, general dictating systems, radio paging, repeaters, etc.
- Convenient, fast and easy.
- Comes completely assembled, no other parts necessary.

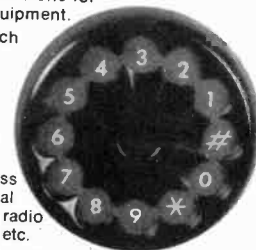

**34.95** EACH  
ADD \$1.00 FOR  
POSTAGE & HANDLING  
CALIFORNIA RESIDENTS  
ADD 6 1/4%



**M&R ENTERPRISES**

P.O. Box 61011, Sunnyvale, California 94088

POPULAR ELECTRONICS

# THE SEMICONDUCTOR COMPONENT LEADER IS NOW YOUR #1 SOURCE FOR ELECTRONIC DATA & APPLICATION BOOKS.

## IC UPDATE MASTER MANUAL

1264 pages. At last IC selection has been simplified. Now you can refer to one source book, the newly revised and updated, second edition of IC MASTER, for the critical selection of integrated circuits. Virtually every IC device manufactured in the United States is listed in the 1977 IC MASTER. Whether an IC exists in a new design, or is one of thousands, you can locate it in seconds by opening the MASTER.

The IC MASTER is divided into 5 major categories: digital, interface, linear, memory and microprocessors. Part number index of all device types made by 84 IC manufacturers. Part number guide allows you to break each company's part numbering system down into product temperature ranges, packaging variations and functions. Complete application notes on all product areas. Quarterly updates. This assures that all this vast body of information is constantly refreshed. These updates are mailed to you direct from the publisher, free of charge, with the completion and return of the enclosed registration card.

Stk No. ICM1000 \$24.95

## Texas Instruments DATA BOOKS

<b>TTL DATA BOOK</b> 832 pages. The new second edition of the TTL Data Book provides the most complete and up-to-date information available concerning the contents of the popular first edition and the 1974 TTL Supplement plus data on new circuits. The contents include detailed specifications on over 900 Texas Instruments device types including standard TTL and high technology Schottky clamped TTL. Pin assignment diagrams of all TTL types including bipolar memories and microprocessors. JAN IC data with 38510 cross-reference tables. Interchangeability guides. A glossary of current IIA and IEC approved terms and symbols. Updated MACH IV Intel program specification. Complete line of TI IC sockets and integrated circuit device types. Stk No. LCC4112 \$4.95	<b>THE OPTO-ELECTRONIC DATA BOOK</b> 368 pages. 252 devices including infrared LEDs, photo detectors, opto-couplers, visible-light emitting diodes, visible diodes, advanced opto products. Required glossary of terms updated in accordance with recent IEC guidelines. Interchangeability guide listing over 800 opto devices. 11 applications arrays on subjects such as operation theory, measurement techniques and device reliability. Stk No. LCC4290 \$2.95	<b>THE SEMICONDUCTOR MEMORY DATA BOOK</b> 272 pages. Detailed specifications on 111 memory products for 61 MOS RAMs, ROMs and Shift Registers. ROMs and PROMs, 7 ECL RAMs, PROM. Plus summary of 11 microprocessor circuits. Complete cross-reference for all available packages types, glossary of symbols and terms used with memory integrated circuits, applications and device reliability. Stk No. LCC4200 \$2.95	<b>THE TRANSISTOR AND DIODE DATA BOOK</b> 1748 pages. 800 transistor type, green junction, multi-junction, uni-junction, and field-effect transistor lists. 500 silicon switching rectifying, voltage-regulating, variable-voltage, and general purpose diodes, as well as multi-element diode arrays and matrices, individual transistor chip characteristics. Stk No. LCC4131 \$7.95	<b>THE POWER SEMICONDUCTOR DATA BOOK</b> 816 pages. Germanium and silicon power transistors, SCRs, thyristors, and power function modules. Silicon power high-voltage and low-voltage, high-safe operating area (SOA) designs, power Darlington, fast switching thyristors, SCR's, thyristors, JMN and JANTX, metal can and plastic packages. Stk No. LCC4841 \$3.95
---	---	---	--	--

**UNDERSTANDING SOLID STATE ELECTRONICS**  
 For anyone who wants to understand how solid-state electronic systems work and how they work together. In solid state electronic systems, A12, diodes, self-heating, course complete with quizzes and glossaries covering the basic theory and use of diodes, transistors, thyristors, optoelectronic devices and digital MOS and linear integrated circuits. Written in layman's language, the course uses only simple arithmetic and requires no technical background.  
 Stk No. LCB1011 \$2.95

**FIELD EFFECT TRANSISTORS**  
 130 pages. In this concise volume you can get all the practical data you need on the theory, characterization, and applications of field effect transistors. The book examines the physical behavior of the field effect transistor, and then explains in detail the electrical characteristics of field effect transistors in circuit applications. It also covers the development of the FET as a crucial element in low level linear, non-linear, and power circuits.  
 Stk No. LCB1071 \$14.95

**MOSFET IN CIRCUIT DESIGN**  
 A Basic Course in 184 pages. It starts with a description of semiconductor devices and their properties, the junction transistor, diodes, and the characteristics of transistors and basic transistor amplifier circuits. It then describes the manufacture of transistors and other semiconductor materials and devices. The book also discusses the wide family of semiconductor devices and examines the applications of integrated circuits.  
 Stk No. LCB1051 \$16.50

**SOLID STATE COMMUNICATIONS**  
 Design of Communication Circuits. Semiconductors in 365 pages. This highly useful book covers in detail the significant advances in field-effect transistors, linear bipolar transistors, and germanium planar epitaxial transistors, and RF to UHF transistors, ranging from 20 MHz to 1000 MHz.  
 Stk No. LCB1131 \$23.50

**DESIGN AND APPLICATION OF TRANSISTOR SWITCHING CIRCUITS**  
 This data book brings you a complete self-contained reference on transistor switching circuits. It describes electrical characteristics of transistors and their relation to the characteristics of switching circuit performance.  
 Stk No. LCB1111 \$24.25

**DESIGNING WITH TTL INTEGRATED CIRCUITS**  
 322 pages. Divided into three volumes. Involved in the planning and design. It formalizes the reader with the entire TTL family, covering not only logic philosophy, economics, basic description, and electrical performance of the devices, but many practical applications of the circuits in digital systems. The authors provide a comprehensive overview of TTL logic families, logic systems and give even the unimagined a clear picture of how actually any logic function can be implemented with TTL integrated circuits.  
 Stk No. LCB1151 \$28.50

**MOS/LSI DESIGN AND APPLICATION**  
 320 pages. This invaluable guide covers the important aspects of MOS and LSI design in solid state electronics.  
 Stk No. LCB121 \$27.50

**SEMICONDUCTOR MEASUREMENTS AND INSTRUMENTATION**  
 A fully illustrated working guide to semiconductors. This excellent manual brings you up to date on all the latest advances in semiconductor measurement, analysis, and defect detection. It details important "hand-me-down" methods, notes, and procedures. Published before the widespread availability of specific measurement techniques, ever assembled ensures that you can find the last approach to any given problem.  
 Stk No. LCB1151 \$18.95

**SOFTWARE DESIGN FOR MICROPROCESSORS**  
 Here is a practical, straightforward guide that makes microprocessor software simple to understand and easier to apply. You learn basic terms, study basic machine architecture and look in detail at instructions as well as concepts. How to build software, support and documentation for software, mechanics of programming, and microprocessor manufacturers' data sheets.  
 Stk No. LCB161 \$12.95

**LINEAR AND INTERFACED CIRCUITS DATA BOOK**  
 688 pages. Where you'll find complete specifications on L1's series of MOS/LSI interface, data transmission, magnetic memory, peripheral driver, memory sense amplifiers, and digital interface circuits. Included are negative and positive voltage translators, differential comparators, line drivers, memory sense amplifiers, sense amps as well as complete cross-reference guide, both numerically and alphabetically.  
 Stk No. LCC4151 \$3.95

**THE LINEAR CONTROL CIRCUITS DATA BOOK**  
 368 pages of operational amplifiers including the new JFET input devices, differential operational amplifiers, voltage regulators, and special functions including mono-flop, Schmitt triggers, precision available only as hybrid circuits. Updated glossary of terms and definitions. Handy selection and complete interchangeability guides, as well as total mechanical and thermal information for all available package types.  
 Stk No. LCC4241 \$2.95

**BIPOLAR MICROCOMPUTER COMPONENTS DATA BOOK**  
 This data book describes a series of high complexity bipolar digital building blocks designed specifically for use in high performance computer or controller systems. Included are the 74S44 and the SPB5900 Microcomputers.  
 Stk No. LCC4270 \$2.85

**THE PERIPHERAL DRIVER DATA BOOK**  
 Total information and typical applications for bipolar microprocessors and microcomputers and interface, including interchangeability guides, thermal information, mechanical data on individual data sheets. Most complete information book.  
 Stk No. LCC4260 \$2.95

**BASIC ELECTRICITY AND DC CIRCUITS**  
 Over 1,000 pages. About half of this book is devoted to worked through examples with step by step solutions. Many students learn about electricity through the study of worked through problems of this sort. Students must often buy an additional book to obtain extra worked through examples. However, a wide variety of problems with solutions is included in the body of this text for use in a large set at the end of each lesson.  
 Stk No. LCB161 \$19.95

## FAIRCHILD DATA BOOKS

**MOS / CCD DATA BOOK**  
 With over 500 pages, this data book provides complete technical information on Fairchild's full lines of "M" and "P" Channel MOS, CMOS, and Charge Coupled Devices (CCD). Included with not only the entire CMOS series, but also the complete MOS Memory, Microprocessor and CCD lines of Fairchild.  
 Stk No. FSB0100 \$4.95

**LOW POWER SCHOTTKY AND MACROLOGIC TTL**  
 Presents an in-depth listing of the complete SCHOTTKY series, 5LS series, and macrologic (9400 series). Includes numerical index of devices, SSI selector, replacement guide and MSI selector guide by function. Also includes data sheets on SSI, MSI and TTL macrologic.  
 Stk No. FSB0101 \$1.75

**LINEAR INTEGRATED CIRCUIT DATA BOOK**  
 Complete technical data on Fairchild's full line of linear integrated circuits. Selection guides by function, a linear integrated circuit cross reference with 1000 devices and their Fairchild direct replacements or nearest equivalents, and a package cross reference for determining equivalent packaging within the industry. Contains an extensive glossary, operational amplifiers, voltage followers and comparators, diode and quad drivers and receivers, diode and transistor arrays, AMF and TV replacement pins, sense amps etc.  
 Stk No. FSB0102 \$6.95

**DESIGNING WITH OPERATIONAL AMPLIFIERS**  
**Application Alternatives**  
 370 pages. Intended for all users of operational amplifiers, this information-packed reference provides numerous diagrams for the most commonly used circuits — complete with explanations of each circuit's operation and adaptability to other applications. The practical limitations of each application are defined and the pertinent design equations are presented to permit rapid selection of components for specific performance characteristics.  
 Stk No. MFB9000 \$17.50

**FB USER'S GUIDE**  
 This book is an in-depth description of the FB components. It includes a detailed description of each device and also provides logic system configurations as well as specific applications.  
 Stk No. FSB0107 \$10.00

**FB GUIDE TO PROGRAMMING**  
 The Guide to Programming is an introduction to machine language and assembly language programming for the FB microprocessor system.  
 Stk No. FSB1008 \$10.00

**FORMULATOR USER'S GUIDE**  
 This book describes how to use the Fairchild FORMULATOR system to convert source programs, written in FORTRAN language, into object programs which can be debugged under software control.  
 Stk No. FSB0109 \$10.00

**FORMULATOR HARDWARE REFERENCE MANUAL**  
 This book presents an in-depth technical description of the FORMULATOR system, its component subsystems and optional capabilities. The technical description is supported by available through subsystem module options. The technical description includes general functional characteristics, theory of operation and detailed description of interface signals.  
 Stk No. FSB0110 \$12.50

**MICROCOMPUTERS FOR ENGINEERS AND SCIENTISTS**  
 353 pages. This book introduces engineers and scientists to the principal features of microcomputers and microcomputing. It is designed to help the reader understand the manufacturer's literature better, to make intelligent choices of microcomputers, peripherals, and application areas, and thus to realize the exceptional possibilities of this new tool.  
 Stk No. MFB0002 \$25.45

## ADVANCED MICRO DEVICES

**MICROPROGRAMMING HANDBOOK**  
 With the advent of the AM2901 4-bit microprocessor and the AM2902 8-bit microprogram sequencer, the design engineer can upgrade the performance of existing systems or implement new systems. Utilizing the latest state-of-the-art technology in LOW POWER Schottky integrated circuits, these devices are familiar to many design engineers. This technology is called MICROPROGRAMMING.  
 Stk No. AMB2000 \$5.00

**A MICROPROGRAMMING 16 BIT COMPUTER**  
 A complete application note to a 16 bit computer including specifications, architecture, machine instructions, arithmetic logic unit, program control unit, memory system, interrupt and master computer control unit.  
 Stk No. AMB2001 \$5.00

**THE 8080/8080A MOS MICROPROCESSOR HANDBOOK**  
 Detailed descriptions of the 8080A central processing unit and the associated cache generator and system controllers. Three important input/output interfaces are then presented followed by 7 groups of detailed circuit diagrams. Following these is a complete chapter on memory devices and the selection of application notes.  
 Stk No. AMB2003 \$7.95

**Siliconix Incorporated**  
**ANALOG SWITCHES AND THEIR APPLICATIONS**  
 The object of this book is to introduce the reader to the FET analog switches and familiarize him with the way that the switch control or driver circuit affects to FET switches. Switching characteristics include: precharge, sample-and-hold circuits, "N" path filters, signal control using analog switches and other applications information.  
 Stk No. SIB3030 \$4.00

**SCHOTTKY AND LOW POWER SCHOTTKY BIPOLAR MEMORY LOGIC AND INTERFACE**  
 This data book contains complete information including the high performance (AM2915) low power Schottky MOS circuits, standard (SN74LS) low power Schottky MOS circuits, and the Schottky MSI circuits, application notes, new LSI products and design and ordering information with package outlines.  
 Stk No. AMB2004 \$5.95

**MOS/LSI DATA BOOK**  
 Including numerical index, functional index, state logic guide, and MOS/LSI cross reference guide, makes this data book a complete and handy reference. Contains static CMOS Random Access Memory (RAM), Dynamic Static Shift Registers, FIFO Memories and complete Microprocessor and support circuits.  
 Stk No. AMB2005 \$5.95

**TELEDYNE SEMICONDUCTOR**  
**JFET APPLICATIONS AND SPECIFICATIONS**  
 Nobody has introduced a single comprehensive manual containing all the available information on JFET's, not until now. Includes cross reference and substitution guide, "N" and "P" channel, dual JFET's, current limits, package outlines and complete application notes.  
 Stk No. TEB3070 \$3.45

**SOLID STATE SCIENTIFIC CMOS "B" SERIES DATA BOOK**  
 Complete technical data for the 4800 series of CMOS integrated circuits. Detailed design information and family characteristic data provide a foundation for effectively utilizing the individual device data sheet selector guides and cross reference information are included to simplify the task of implementing system design efficiently and economically.  
 Stk No. SSB5000 \$3.00

**RAYTHEON**  
**RAYTHEON LINEAR INTEGRATED CIRCUITS**  
 With complete manufacturers cross reference data sheets, complete data book information, operational amplifiers, precision, high gain instrumentation, high performance op-amps etc. Also includes wide range amplifiers, negative and positive voltage regulators, dual tracking comparators, line drivers and receivers, as well as special functions such as a wide range of comparators.  
 Stk No. RAB5000 \$1.95

With every order, you will receive, free of charge, our new comprehensive 1977 fall catalogue (\$2.00 value), listing complete descriptions, illustrations, and special monolithic pricing on over 10,000 items.

Only the best quality, most informative books have been hand chosen to provide authoritative specific information on all phases of semiconductor technology.

P.O. BOX 1035 FRAMINGHAM, MASSACHUSETTS 07011  
 Telephone Orders & Enquiries (617) 879-0077 New Catalogue available on request

NOW IN CANADA 2 Locations  
 5647 Ferrier st. Montreal, Quebec Tel. (514) 735-6429  
 44 Faeken Dr-Unit 25 Rexdale, Ontario Tel. (416) 877-4287

MINIMUM ORDER \$10.00 + ADD \$1.00 TO COVER POSTAGE & HANDLING \* Canadian customers add 30% for duty and handling. All federal and provincial taxes extra

# ADVANCED MICROCOMPUTER PRODUCTS

## MOTOROLA EXORCISER & MEK D1 & MEK D2 COMPATIBLE MODULES

MEK800D2 - 6800 KIT ONLY \$235.00  
 9626K BK Slave RAM Kit 375.00  
 9626K 8 Pin Display Slave RAM Kit 395.00  
 9626K 16 Pin Display Slave RAM Kit 415.00  
 All assembly & tested unit kits  
**PLUS MOTOROLA TV MONITORS - PRIME**  
 Model M3000 100 12" display \$219.95  
 Model M2000 155 9" display \$199.95  
 Add \$10.00 for shipping

MICROPROCESSORS		PROM'S		IC MARKET PLACE	
80001	1.98	6330	1.39	74200	9.95
80011	1.98	6330	1.39	74201	9.95
80021	1.98	6330	1.39	74202	9.95
80031	1.98	6330	1.39	74203	9.95
80041	1.98	6330	1.39	74204	9.95
80051	1.98	6330	1.39	74205	9.95
80061	1.98	6330	1.39	74206	9.95
80071	1.98	6330	1.39	74207	9.95
80081	1.98	6330	1.39	74208	9.95
80091	1.98	6330	1.39	74209	9.95
80101	1.98	6330	1.39	74210	9.95
80111	1.98	6330	1.39	74211	9.95
80121	1.98	6330	1.39	74212	9.95
80131	1.98	6330	1.39	74213	9.95
80141	1.98	6330	1.39	74214	9.95
80151	1.98	6330	1.39	74215	9.95
80161	1.98	6330	1.39	74216	9.95
80171	1.98	6330	1.39	74217	9.95
80181	1.98	6330	1.39	74218	9.95
80191	1.98	6330	1.39	74219	9.95
80201	1.98	6330	1.39	74220	9.95
80211	1.98	6330	1.39	74221	9.95
80221	1.98	6330	1.39	74222	9.95
80231	1.98	6330	1.39	74223	9.95
80241	1.98	6330	1.39	74224	9.95
80251	1.98	6330	1.39	74225	9.95
80261	1.98	6330	1.39	74226	9.95
80271	1.98	6330	1.39	74227	9.95
80281	1.98	6330	1.39	74228	9.95
80291	1.98	6330	1.39	74229	9.95
80301	1.98	6330	1.39	74230	9.95

## LOGOS 1 THE BEST 8K RAM KIT

AV38500-1/TMS 1955 ONLY \$16.95  
 AV38500 (Europe Version) \$24.95  
 TV KIT NO. 2 Parts less chassis \$39.95  
 Special CI Ram Complete \$39.95  
 (Repairable stock for \$89.95)

The last word in 8K Ram Boards.  
 Special Price of only \$219.95  
 Features:  
 Lowpower 21L02, 4050s, Dip Switch  
 Selectable addressing down to 256  
 Byte blocks, No wait states, Fully buffered, battery back-up.  
 Plus the first 32K Static Memory Board Uses 2116 4K RAM'S

16K \$79.95  
 24K \$79.00  
 32K \$109.95  
 (Note, supply contingent on 2116 availability. Allow 30 days)

DATA BOOKS  
 NSC Digital \$3.95  
 NSC Linear \$3.95  
 NSC LAM Vol 1 \$3.95  
 NSC LAM Vol 2 \$3.95  
 NSC CMOS \$3.95  
 NSC Audio \$3.95  
 NSC Voltage Reg \$3.95  
 NSC Memory \$3.95  
 NSC Special Functions \$3.95  
 NSC Manuals \$3.95  
 NSC Transistors \$3.95  
 Invt Microprocessor Handbooks \$3.95  
 Last Complete on Learning Course \$9.50  
 Intel MCS80 Manual \$9.95  
 Intel MCS85 Manual \$9.95  
 Raytheon Linear \$9.95  
 Raytheon Quad/Dual \$9.95  
 TI Linear Control \$9.95  
 Osborne Intro Microproc Vol 1 \$7.50  
 Osborne Intro Microproc Vol II \$7.50  
 Osborne 8080 Programming for Logic Design \$7.50  
 Osborne 8080 Programming \$7.50

## COMPUTER KITS

MOT MEK800 D2 235.00  
 KIM 16502 Kit 245.00  
 AEM EVK 99 Kit 133.00  
 Interim J100 Kit 281.00  
 XCS Computerbook 450.00  
 NSC Scamp Kit 99.00  
 NSC Keyboard Kit 95.00  
 IMSA 8080A w/2 PIC B Priority 751.00  
 SID Kit 125.00  
 Byte Computer 2 2 595.00  
 Byte Server 145.00  
 Bytesaver w/PROM 195.00  
 Dazlist 215.00  
 D + 7A 145.00  
 JS-1 Joystick 65.00  
 BK EPROM/RAM Kit 124.95  
 ZPU Kit 295.00

## S-100 COMPATIBLE PRODUCTS

Logic 8K Ram Board \$219.95  
 801E 8K Ram Board \$198.00  
 801E Memory Board (Expansion) \$ 79.95  
 w/Connection  
 Encoder Board \$ 34.95  
 Universal Print-Board w/Intrusion \$ 39.95  
 In-line 30 Board \$109.95  
 Label Cassette \$120.00

All Shipments FOM or UPS, Orders under \$100.00 add 5% handling and postage. Orders over \$100.00 add 2.5% handling & postage. Mastercharge/BankAmericard/COD accepted w/25% deposit. California Residents add 6% tax. Foreign Orders add 8% handling. All parts prime factory tested guaranteed. Same day shipment. Add 25 cents for Osta.

ADVANCED MICROCOMPUTER PRODUCTS  
 P. O. BOX 17329  
 Irvine, California 92713  
 New Phone (714) 558-8813

★ NOW Our First Store Open 1310 B Edinger Santa Ana, CA 92705 ★

CIRCLE NO. 4 ON FREE INFORMATION CARD

## PLANNING TO MOVE?

Let us know 8 weeks in advance so that you won't miss a single issue of **POPULAR ELECTRONICS**. Attach old label where indicated and print new address in space provided. Also include your mailing label whenever you write concerning your subscription. It helps us serve you promptly.

Write to: P.O. Box 2774, Boulder, CO 80322 giving the following information:

Change address only  Extend my subscription

**ENTER NEW SUBSCRIPTION**

1 year \$12.00  Payment enclosed (1 extra BONUS issue)  
 Allow 30-60 days for delivery.

Bill me later

AFFIX OLD LABEL

If you have no label handy, print OLD address here.

Name \_\_\_\_\_ please print

Address \_\_\_\_\_

City \_\_\_\_\_

State \_\_\_\_\_ Zip \_\_\_\_\_

NEW ADDRESS HERE 0209

Name \_\_\_\_\_ please print

Address \_\_\_\_\_ Apt. \_\_\_\_\_

City \_\_\_\_\_

State \_\_\_\_\_ Zip \_\_\_\_\_

Additional postage on foreign orders: add \$3 a year for Canada, \$5 a year for all other countries outside the U.S. and its possessions. Cash only on foreign orders, payable in U.S. currency.

ELIMINATE TV INTERFERENCE With proven new electronic filters. "White Knight" filter attaches to TV, eliminating front-end overload. \$9.95 postpaid. "White Hat" filter connects to any CB, reducing harmonic radiation interference. \$12.95. Simple installation. Satisfaction guaranteed. Free information. Fairhouse PE, Box 696, Los Altos, California 94022.

DIGITAL TACHOMETER 4-6-8 cylinder two digit display. Complete \$59.95. Cosmos Electronics, P.O. Box 33278, Seattle, WA 98133.

PAIA 2720/A Synthesizer. Write: B. Fruechtig, Box 1234, Las Vegas, N.M. 87701.

AMAZINGLY Low component prices! Ask for free flyer. Writing: EEP, 11 Revere Place, Tappan, NY 10983.

HARDCOPY. Attachment converts Smith-Corona electric typewriters, others, to microcomputer printout. Free Brochure. Stout Microcomputer, Box 1573, Fremont, CA 94538.

ELECTRONICS MODULES: Active filters, CMOS/TTL clock generator. Send 25 cents for details. EL-TECH, INC., P.O. Box 744, Rockville, Conn. 06066.

WEATHER MAP RECORDERS: Copy Satellite Photographs, National-Local Weather Maps. Learn How! \$1.00. Atlantic Sales, 3730 Nautilus Ave., Brooklyn, N.Y. 11224. Tel: (212) 372-0349.

## PLANS AND KITS

AMAZING ELECTRONIC PRODUCTS  
 LASERS SUPER POWERED, RIFLE, PISTOL, POCKET, SEE IN DARK, PYRO, TECHNICAL, DE-BUGGING, UNCRAMBERS, GIANT TESLA, STUNWAND, TV DISRUPTER, ENERGY PRODUCING, SCIENTIFIC DETECTION, ELECTRICIFYING, CHEMICAL, ULTRASONIC, CB, AERO, AUTO AND MECH DEVICES, HUNDREDS MORE - ALL NEW PLUS INFO UNITS PARTS SERVICE

**INFORMATION unlimited**  
 Box 626 Lord Jeffery Pz • Amherst, N.H. 03031

FREE KIT Catalog contains Test and Experimenter's Equipment. Dage Scientific Instruments, Box 1054P, Livermore, CA 94550.

**TIGER SST SIMPLI-KIT**

FOR THE DO-IT-YOURSELFER

**NOW!** a high quality CD Electronic Ignition System in kit form.

Contains all components and solder to build complete Solid State Electronic CD Ignition System for your car. Assembly requires less than 3 hours.

- Increases MPG 15%
- Increases horsepower 15%
- Plugs and Points last 50,000 miles
- Eliminates 4 of 5 tune-ups
- Instant starting, any weather
- Dual system switch

Fits only 12 volt neg. ground... Only \$21.95 postpaid

**Tri Star Corporation**  
 P.O. Box 1727 Grand Junction, Colorado 81501

**WERSI KITS**

Organs, Pianos, Strings Rhythms, PA Systems

**104-page catalog \$2**

WERSI electronics, Inc.  
 Dept. A2, Box 5318, Lancaster, PA 17601

POCKET COLOR/BAR GENERATOR kit, 16 patterns, \$49.95. Plans, \$4.95. Workshop, Box 393PD, Bethpage, New York 11714.

TESLA COIL — 40" SPARKS! Plans \$7.50. Information 75 cents. Huntington Electronics, Box 2009-P, Huntington, Conn. 06484.

## HIGH FIDELITY

DIAMOND NEEDLES and Stereo Cartridges at Discount prices for Shure, Pickering, Stanton, Empire, Grado and ADC. Send for free catalog. LYLE CARTRIDGES, Dept. P, Box 69, Kensington Station, Brooklyn, New York 11218.



# DIGI-KEY CORPORATION

Quality Electronic Components

## DON'T FORGET OUR DISCOUNTS WHEN COMPARING PRICES

### PRICE BREAKTHROUGH ON 74LS'

74LS00	.28	74LS30	.28	74LS90	.57	74LS157	.75	74LS248	.79
74LS01	.28	74LS32	.33	74LS92	.57	74LS158	.75	74LS249	.79
74LS02	.28	74LS33	.33	74LS93	.57	74LS160	1.02	74LS253	.84
74LS03	.28	74LS38	.33	74LS107	.39	74LS161	1.02	74LS257	.75
74LS04	.29	74LS40	.28	74LS109	.39	74LS162	1.02	74LS258	.75
74LS05	.29	74LS42	.28	74LS112	.39	74LS163	1.02	74LS266	.39
74LS08	.29	74LS47	.29	74LS113	.39	74LS164	1.02	74LS283	.79
74LS09	.29	74LS48	.29	74LS114	.39	74LS168	1.14	74LS290	.65
74LS10	.28	74LS51	.28	74LS125	.49	74LS169	1.14	74LS293	.65
74LS12	.28	74LS54	.28	74LS132	.81	74LS173	1.34	74LS365	.67
74LS13	.47	74LS57	.39	74LS136	.39	74LS174	1.34	74LS366	.67
74LS14	1.02	74LS74	.39	74LS138	.73	74LS175	1.34	74LS367	.67
74LS15	.28	74LS75	.39	74LS139	.73	74LS181	1.18	74LS386	.39
74LS21	.28	74LS76	.39	74LS151	.75	74LS191	1.18	74LS670	2.34
74LS22	.28	74LS78	.39	74LS153	.75	74LS196	.86	74LS99	.77
74LS26	.33	74LS83	.39	74LS154	1.10	74LS207	1.14	74LS99	.77
74LS27	.33	74LS86	.39	74LS156	.75	74LS247	.79	74LS99	.77

## NEW

### Battery wire wrapping tool

**\$34.95**  
ONLY \$39.95 (street price)  
COMPLETE WITH BIT AND SLEEVE

WIRE WRAPPING WIRE IN BULK

100'	\$2.00	500'	\$8.50	1000'	\$15.00
------	--------	------	--------	-------	---------

Red or Black 30 ga. Kynar

## LED DUAL DIGITS

NSN373 0.3" CC	.....	\$2.20/dual digit display
NSN374 0.3" CA	.....	\$2.20/dual digit display
NSN583 0.5" CC	.....	\$2.60/dual digit display
NSN584 0.5" CA	.....	\$2.60/dual digit display
NSN783 0.7" CC	.....	\$3.00/dual digit display
NSN784 0.7" CA	.....	\$3.00/dual digit display

ALL LEADS BROUGHT OUT FOR EASE OF APPLICATION

0.3" Digits Actual Size 0.85" x 0.8"

0.7" Digits Actual Size 1.25" x 1.2"

0.5" Digits Actual Size 1.05" x 1.0"

**NEW!**

### INTEGRATED CIRCUITS — TTL, CMOS, LINEAR & MOS

7400	.21	7476	.32	74181	.215	4012	.23	4520	1.14
7401	.21	7482	.70	74182	.79	4013	.40	4527	1.68
7402	.21	7483	.70	74184	2.19	4014	.96	4528	.88
7403	.21	7485	.89	74185	2.19	4015	.96	4985	1.20
7404	.21	7486	.89	74189	3.50	4016	.40	7102-1	1.99
7405	.21	7489	2.19	74190	1.23	4017	1.05	8080A	24.95
7406	.25	7490	2.19	74191	1.23	4018	1.05	CA3046	.75
7407	.25	7491	.70	74192	.88	4019	.23	LM2711N	1.25
7408	.21	7492	.44	74193	.88	4020	1.14	LM309K	1.80
7409	.21	7493	.44	74194	.88	4021	1.14	LM324A	1.28
7410	.21	7494	.70	74195	.88	4022	.96	LM340T-5	1.25
7411	.21	7495	.70	74196	.88	4023	.23	LM340T-6	1.25
7412	.21	7496	.70	74197	.88	4024	.84	LM340T-8	1.25
7413	.25	7497	.70	74198	1.49	4025	.23	LM340T-12	1.25
7414	.89	74100	1.28	74199	1.49	4026	1.68	LM340T-15	1.25
7416	.25	74101	.30	74200	.89	4027	.40	LM340T-18	1.25
7417	.25	74102	.33	74201	1.99	4028	.89	LM340T-24	1.25
7420	.21	74103	.35	74209	.55	4029	1.14	LM3909N	.88
7421	.25	74104	.44	74365	.67	4030	.23	LM3909N	.69
7423	.35	74105	.44	74366	.67	4031	.51	MC14561	1.00
7425	.35	74106	.40	74367	.67	4032	1.20	MC1458V	.53
7426	.25	74107	.40	74368	.67	4033	3.50	MC1458V	.53
7427	.33	74108	.70	74369	.67	4034	.84	MC3302P	1.15
7428	.28	74109	.70	74370	.67	4035	1.14	NE536T	3.24
7429	.28	74110	.70	74371	.67	4040	1.14	NE540L	2.04
7430	.21	74111	.70	74372	.67	4041	.79	NE555V	.48
7431	.21	74112	.70	74373	.67	4042	.79	NE568A	.88
7432	.25	74113	1.63	74374	.67	4043	.70	NE568B	.88
7433	.30	74114	1.30	74375	.67	4044	.70	NE568C	3.83
7434	.25	74115	1.16	74376	.67	4046	1.86	NE568V	1.28
7435	.25	74116	1.16	74377	.67	4049	.40	NE568V	1.28
7436	.21	74117	1.63	74378	.67	4050	.40	NE655A	1.25
7437	.25	74118	1.30	74379	.67	4051	1.26	NE660V	1.28
7438	.25	74119	1.30	74380	.67	4052	1.26	NE670V	.44
7439	.21	74120	1.30	74381	.67	4053	1.26	uA709CV	.44
7440	.21	74121	1.30	74382	.67	4054	1.26	uA710CA	.44
7441	.21	74122	1.30	74383	.67	4055	1.26	uA711CA	.53
7442	.21	74123	1.30	74384	.67	4056	1.26	uA722CA	.60
7443	.63	74124	1.30	74385	.67	4057	.23	uA733CA	.75
7444	.21	74125	1.30	74386	.67	4058	.23	uA741CV	.44
7445	.21	74126	1.30	74387	.67	4059	.23	uA747CA	.44
7446	.21	74127	1.30	74388	.67	4061	.79	uA768CV	.49
7447	.21	74128	1.30	74389	.67	4062	.23	uA780SCU	1.25
7448	.21	74129	1.30	74390	.67	4063	.23	uA780SCU	1.25
7449	.21	74130	1.30	74391	.67	4064	.23	uA781SCU	1.25
7450	.21	74131	1.30	74392	.67	4065	.23	uA781SCU	1.25
7451	.21	74132	1.30	74393	.67	4066	.23	uA7824CU	1.25
7452	.21	74133	1.30	74394	.67	4067	.23		
7453	.21	74134	1.30	74395	.67	4068	.23		
7454	.21	74135	1.30	74396	.67	4069	.23		
7455	.21	74136	1.30	74397	.67	4070	.23		
7456	.21	74137	1.30	74398	.67	4071	.23		
7457	.21	74138	1.30	74399	.67	4072	.23		
7458	.21	74139	1.30	74400	.67	4073	.23		
7459	.21	74140	1.30	74401	.67	4074	.23		

## MA1003 CAR CLOCK

NEW — FOR CAR OR BOAT!

The MA1003 bright green fluorescent display offers a brilliance that cannot be achieved by LED displays, a feature that sold Detroit!

**NEW!**

12 Hour Only  
12 Volt DC  
Crystal Time Base  
Bright Green Digits  
Assembled and Tested

MA1003 ..... \$24.95

0.3" Digits Actual Size 1.75" x 3.05"

**NEW!**

## MA1002 0.5" High Digits

Actual Size: 1.375" x 3.05"

MA1002A	12 Hour AM-PM	\$10.50
MA1002C	24 Hour	\$10.50
SPECIAL TRANSFORMER & SWITCHES		\$3.45

## ABOUT OUR CLOCKS

The MA1002 and MA1010 series clock modules by National Semiconductor are fully assembled and tested clocks using a 4 digit LED display and on MOS integrated circuit on the same board. Simply connect switches and our special transformer and you have a fully functioning clock.

The MA1003 clock module is a fully assembled and tested 12 hour clock using a high brilliance green fluorescent display and crystal time base making it perfect for car, boat or other portable use. It operates directly from 12 volts DC, no transformer is needed. Our price includes three push button switches for setting the time.

MA1002A	5" LED 12 Hour AM-PM Clock Module	\$10.50
MA1002C	5" LED 24 Hour Clock Module	\$10.50
MA1002C SET	Module with Transformer & Switches	\$13.95
MA1003	12 Volt Car Clock with Switches	\$24.95
MA1010A	8" LED 12 Hour AM-PM Clock Module	\$13.00
MA1010A SET	Module with Transformer & Switches	\$16.45
MA1010C	8" LED 24 Hour Clock Module	\$13.00
MA1010C SET	Module with Transformer & Switches	\$16.45

### RADIAL ELECTROLYTICS

47/50V	.38	65/10	.12	100/10	.30	330/25V	.23	1.86/10
1/50V	.08	65/10	.12	100/10	.30	470/10R	.21	1.71/10
2/250V	.08	65/10	.12	100/10	.30	470/10V	.29	2.35/10
3/350V	.08	65/10	.12	100/10	.30	1000/10V	24	1.96/10
4/735V	.08	65/10	.12	100/25V	.13	1000/16V	29	2.5/10
4/735V	.08	65/10	.12	100/50V	.21	1000/25V	42	3.33/10
10/16V	.38	65/10	.12	220/16V	.15	1000/10V	42	3.33/10
10/25V	.38	65/10	.12	220/16V	.15	2200/10V	48	3.33/10
10/50V	.38	65/10	.12	220/25V	.21	2200/16V	62	4.95/10
22/16V	.08	67/10	.12	220/50V	.29	2200/25V	58	4.47/10
22/25V	.09	70/10	.12	330/10V	.15	3300/16V	89	7.14/10
				330/16V	.21	3300/25V		

## MA1010 0.84" High Digits

Actual size: 1.75" x 3.75"

MA1010A	12 Hour AM-PM	\$13.00
MA1010C	24 Hour	\$13.00
SPECIAL TRANSFORMER & SWITCHES		\$3.45

### DATA BOOKS

TTL IC's 595 p	.....	\$4.00
Linear IC's 957 p	.....	\$5.00
CMOS 74C 256 p	.....	\$3.00
Memory IC's 592 p	.....	\$3.00
Interface IC's 464 p	.....	\$3.00
Watt. Regs. 126 p	.....	\$3.00
Linear Appl. 1 432 p	.....	\$4.00
Linear Appl. 2 246 p	.....	\$3.00
Audio 196 p	.....	\$3.00
MOS/LSI IC's 713 p	.....	\$4.00
CMOS 4000 278 p	.....	\$3.25
Analog Manual 637 p	.....	\$5.95

### AXIAL ELECTROLYTICS

47/10V	.11	50/10	.14	115/10	.19	330/16V	.29	2.5/10
1/30V	.11	50/10	.14	115/10	.19	330/25V	.32	2.54/10
3/335V	.12	95/10	.14	115/10	.19	470/16V	.32	2.55/10
3/350V	.12	100/10	.17	130/10	.21	470/25V	.37	3.00/10
4/735V	.12	95/10	.14	115/10	.19	1000/10V	24	2.45/10
10/16V	.38	65/10	.12	100/50V	.21	1000/16V	29	2.5/10
10/25V	.38	65/10	.12	220/16V	.15	1000/25V	42	3.33/10
10/50V	.38	65/10	.12	220/16V	.15	2200/10V	42	3.33/10
22/16V	.08	67/10	.12	220/50V	.29	2200/16V	62	4.95/10
22/25V	.09	70/10	.12	220/50V	.29	2200/25V	58	4.47/10
				330/10V	.15	3300/16V	89	7.14/10
				330/16V	.21	3300/25V		

### WIRE-WRAPPING TOOL

**\$5.95**

Wraps, Unwraps & Strips 30 ga. Wire

### 1/2 & 1/4 WATT 5% CARBON FILM RESISTORS

Each each in multiples of 5 per value  
\$1.70/100 & \$12.00/1000 of same value  
1 ohm thru 1.0 megohm

### DOUBLE-DIGIT DISCOUNT SCHEDULE

Merchandise	Discount	Merchandise	Discount
\$ 0.00-\$24.99	NET	\$100.00-\$499.99	3% to 15%
\$ 25.00-\$49.99	NET	\$500.00-\$999.99	5% to 20%
\$ 50.00-\$99.99	Less 10%	\$1000.00 & Up	Less 25%

Then Add the Standard Charge Below

STANDARD SHIPPING/HANDLING CHARGE

If your merchandise total after discount is between:

\$ 0.00 & 1.00	add \$2.00	\$ 50.00-\$99.99	add \$0.25
\$ 1.00-\$24.99	add \$0.75	\$ 100.00 & up	No Charge

\$25.00-\$49.99 add \$0.50

Includes shipping and insurance in USA & Canada

COD ORDERS ACCEPTED FOR SAME DAY SHIPMENT — CALL 218-681-6674



# BULLET ELECTRONICS

(214)823-3240  
P.O. BOX 19442P  
DALLAS, TEXAS 75219

**THE MK-05 MINI MOBILE** is a compact 6 digit DC clock with a quartz xtal timebase and alarm capability. The readout is a magnified .125" LED calculator readout. Kit comes complete with all components, PC board and instructions. 12 hour format only. Do not be fooled by our low price, this is a quality time-piece with voltage and noise suppression. 2 1/2" X 2 1/4" X 1 1/2" \$12.95

**Own the most unique electronic clock on the market!** The MG-01 MINI GRANDFATHER has a swinging pendulum, matching tick-tock sound, and a pleasant bell-like chime that is adjustable in pitch, volume and sustain. The chime sounds and counts the hours (ie: 3 times for 3 o'clock). Kit comes complete with 2 plated and drilled PC boards (6 5/8" X 4 5/8"), 7 CMOS integrated circuits and a 40 pin clock IC. Also included are switches, speaker, bright 4 digit .5" LED display with color and all necessary electronic components. \$39.95 Kit (less case) Beautiful solid wood case over 8" tall custom cut for the MG-01 with ruby front filter and drilled rear panel. Available in BNLUT or ASH (please specify). \$18.95 finished, shipped unassembled

**OUR CUSTOMERS WRITE ABOUT OUR CDI KIT:**  
"... great kit."  
"... unbelievable value."  
"... good design!"  
"... fantastic kit and service. Send three more."

The CDI kit is all these things and more. Get in on a one time deal. Complete electronics. \$9.95  
Requires heatsink (not included) also works for voltage source for high intensity strobe.

### MK-03 AIRCRAFT/CLOCK TIMER KIT

You don't have to be a pilot to need the MK-03. If you want a mobile clock that offers six 4" LED readouts, 24 hour real time readout, 24 elapsed time readout, alarm, snooze, display blanking. Timer and clock share same set of readouts but are totally independent of each other. Timer has reset and freeze feature. Many other options are available. Sold less case and switches because of the various mountings and options available. \$26.95 complete electronics and boards less switches and case.

### ULTRASONIC SENDER-RECEIVER KIT

A special buy on a high quality ultrasonic transducer allows us to offer this kit at a super price - but hurry, quantities are limited! You can build intrusion alarms, motion detectors, remote controls, echo ranging or liquid level measurement equipment. We supply the basic transmitter and receiver electronics including a drilled and plated PC board. The units work at 23KHZ with a range of 20 ft. and can be positioned opposite each other or side-by-side and bounced off a solid surface. The output will sink up to 300ma to drive a relay, alarm circuit, etc. **ORDER US-01** \$19.95

**AUTOMATIC TIME-OUT CIRCUIT** for ultrasonic or mechanical switch alarms. Provides a five second entry delay. Sounds alarm for one minute, then re-arms itself. Requires 6-15VDC. \$3.95

**TERMS:** NO COD'S \* Send check or M.O. \* Add 5% postage  
Tx. Residents add 5% sales tax \* Foreign add 10% (20% airmail)  
Orders under \$10. add 60c handling \* Repair service available  
Accepting phone orders on Master Charge and BankAmericard.

CIRCLE NO. 10 ON FREE INFORMATION CARD

## WANTED

GOLD, Silver, Platinum, Mercury wanted. Highest prices paid by refinery. Ores assayed. Free circular. Mercury Terminal, Norwood, MA 02062.

## TUBES

RADIO & T.V. Tubes--36 cents each. Send for free Catalog. Cornell, 4213 University, San Diego, Calif. 92105.

TUBES receiving, factory boxed, low prices, free price list. Translateronic, Inc., 1365 39th Street, Brooklyn, N.Y. 11218A, Telephone: 212-633-2800.

TUBES: "Oldies", Latest. Supplies, components, schematics. Catalog Free (stamp appreciated). Steinmetz, 7519-PE Maplewood, Hammond, Ind. 46324.

## CLASSIFIED ADVERTISING ORDER FORM

1	2	3
4	5	6
7	8	9
10	11	12
13	14	15
16	17	18
19	20	21
22	23	24
25	26	27
28	29	30

PRINT NAME

ADDRESS

CITY

STATE

ZIP

SIGNATURE

Please refer to heading on first page of this section for complete data concerning terms, frequency discounts, closing dates, etc. **WORD COUNT: 15 WORD MINIMUM.** Include name and address.

### Words

\$2.25 (Commercial Rate)  
\$1.35 (Reader Rate)  
\$3.35 (Expand-Ad Rate)

Payment of \$ enclosed for \_\_\_\_\_ insertions.  
 AmEx  BAC  
 MC  Diners

CHARGE: for \_\_\_\_\_ Insertions.  
You will be billed monthly.

Account # \_\_\_\_\_

Expiration Date \_\_\_\_\_  
Master Charge Interbank # (4 digits above name) \_\_\_\_\_

SIGNATURE MUST BE PROVIDED BELOW.

PE-877

### UNIVERSAL 4K x 8 MEMORY BOARD KIT \$74.50

32-2102-1 fully buffered, 16 address lines, on board decoding for any 4 of 64 pages, standard 44 pin buss.

### EXPANDABLE F8 CPU BOARD KIT \$99.00

featuring Fairbug PSU, 1K of static ram, RS 232 interface, documentation, 64 BYTE register CD4026 - \$1.25 CD4046 - \$2.20

### 4K BASIC FOR FAIRBUG F8 \$25.00

on paper tape

### NEW COMPUTER INTERFACE BOARD KIT

Kit allows you to interface serial TTL to RS 232 and RS 232 to TTL. Four of these are supplied with kit, you can run up to four devices on one TTL or four separate TTL to RS 232 devices. Typical use: you can use your computer ports to run an RS 232 printer, video terminal and two other RS 232 devices at once, without constantly connecting and disconnecting your terminals. Example: out store to printer-voltage requirement +5V and +5V or +12V depending on your RS 232 device. We supply - board, connectors, documentation and components. Sorry, we do not supply case or power supply. \$49.00

**24, EIGHT CONDUCTOR SPECTRA FLAT CABLE 100/313-50**  
8 PIN - 22 24 PIN - 40  
14 PIN - 25 28 PIN - 50  
16 PIN - 28 40 PIN - 60  
18 PIN - 30  
#30 WIRE WRAP WIRE SINGLE STRAND 100/751-40

**2708 8K EPROM \$24.95**  
2522 STATIC SHIFT REG \$1.95  
2513 CHARACTER GEN \$9.95  
2518-HEX 3 BIT SR \$3.50  
2102-1 1024 BIT RAM \$1.29  
5280 4K DYNAMIC RAM \$4.75  
MM5202A UV PROM \$6.95  
MM5203 UV PROM \$6.95  
1702A 4K PROM \$4.95  
5204-4K PROM \$10.95  
AY-5-1013 UART \$6.95

LIGHT ACTIVATED SCR'S TO 18, 200V IA \$1.75  
IN 4148 (1N914) 15/31-20  
MCA 81 OPTICAL LIMIT SWITCH \$1.50

**LED READOUTS**  
FND 359 C.C. 4" .50 HP 7740 .3" C.C. \$1.25  
FND 70 C.C. 4" .55 MAN-7 .3" C.A. \$9.95  
FND 503 C.C. 5" NS 33-3 disp array \$7.75  
FND 510 C.A. 5" .85 DI 747 C.A. 8" \$9.95

Terms: FOB Cambridge, Mass. Send 25¢ for our catalog featuring Transistors and Rectifiers 145 Hampshire St., Cambridge, Mass.

### PRINTED CIRCUIT BOARD

4 1/2" x 6 1/2" SINGLE SIDED EPOXY BOARD 1/16" thick, unetched \$5/\$2.60

### 7 WATT LD-65 LASER DIODE IR \$89.50

2N 3820 P FET \$ .45  
2N 5457 N FET \$ .45  
2N2646 \$ .45  
ER 900 TRIGGER DIODES 4/ \$1.00  
2N 6028 PROG UJT \$ .65

**MINIATURE MULTI-TURN TRIM POT'S**  
100, 500, 1K, 2K, 5K, 10K, 25K, 50K, 100K, 200K 500K 1 Meg \$2.5 each. 3/2.00

**MULTI-TURN TRIM POT'S** Similar to Bourmans 3010 style 3/16" x 5/8" x 1 1/4" 50, 100, 1K, 10K, 50K ohms \$1.50 each. 3/1.50

**VERIPAX PC BOARD**  
This board is a 1/16" single sided paper epoxy board. 4 1/2" x 6 1/2" DRILLED and ETCHED which will hold up to 21 single 14 pin IC's or 8, 16, or LSI DIP IC's with busses for power supply connector. \$4.00

MV 5691 YELLOW-GREEN \$ .90  
BIPOLAR LED \$ .50  
FP 100 PHOTO TRANS \$ .50  
RED, YELLOW, GREEN or AMBER  
LED LED'S 6/51.00  
1L-5 (MCT-2) \$ .75  
MOLEX PINS 100/\$1.00  
1000/\$8.00

**10 WATT ZENERS 3.9, 4.7, 5.6, 8.2, 12, 15, 18, 22, 100, 150 or 200V ea. \$ .60**  
**1 WATT ZENERS 4.7, 5.6, 10, 12, 15, 18 or 22V ea. \$ .25**  
MC6860 MODEM CHIP 100/\$9.95

### Silicon Power Rectifiers

PRV 1A	3A	12A	50A	125A
100 06	14	30	80	3.70
200 07	20	35	1.15	4.25
400 09	25	50	1.40	6.50
600 11	30	70	1.80	8.50
800 15	35	90	2.30	10.50
1000 20	45	110	2.75	12.50

### SILICON SOLAR CELLS

2 1/2" diameter  
4V at 500 ma. \$4.00 / 2V at 200 ma \$2.00

### REGULATORS

709K \$ .95 340K-5, 12, 15  
323 \$ .50 or 24V \$ .85  
LM 376 \$ .60 340T-5, 6, 8, 12  
320K-5 or 15V \$1.40 78 MG 15, 18 or 24V \$1.10  
320T-5, 12, 15 \$1.40 79 MG \$1.35  
or 24V \$ .85 79 MG \$1.35

**RS232 CONNECTORS** DB 25P male \$3.25  
DB 25S female \$3.95

### TRANSISTOR SPECIALS

2N3585 NPN Si TO-66 \$ .95  
2N3772 NPN Si TO-3 \$ 1.60  
2N4564 PNP GE \$ 1.75  
2N4509 PNP Si TO-3 \$ 1.00  
2N6055 NPN Si TO-3 Darlington \$ 1.70  
2N5086 PNP Si TO-92 4/S \$ 1.00  
2N4898 PNP TO 66 \$ .60  
2N404 PNP GE TO-5 5/S \$ 1.00  
2N3919 NPN Si TO-3 RF \$ 1.50  
MPSA 13 NPN Si TO-92 3/S \$ 1.00  
2N1871 NPN Si TO 66 \$ .70  
2N2222 NPN Si TO 18 5/S \$ 1.00  
2N3055 NPN Si TO-3 5/S \$ .70  
2N3904 NPN Si TO-92 5/S \$ 1.00  
2N3906 PNP Si TO-92 5/S \$ 1.00  
2N5296 NPN Si TO-220 \$ .50  
2N6103 PNP Si TO-5 5/S \$ .55  
2N3638 PNP Si TO-5 5/S \$ 1.00  
2N6517 NPN TO-92 Si 3/S \$ 1.00

**TTL IC SERIES**  
7400-14 7445-15 74150-90  
7401-14 7446-16 74151-60  
7402-14 7447-17 74152-60  
7403-14 7448-18 74153-60  
7404-18 7449-19 74154-95  
7405-18 7472-29 74157-58  
7406-25 7473-29 74161-85  
7407-25 7474-29 74163-80  
7408-18 7475-30 74164-95  
7409-17 7476-30 74165-95  
7410-14 7480-35 74173-120  
7411-20 7483-62 74174-95  
7412-20 7485-87 74175-82  
7413-39 7486-30 74176-75  
7414-63 7489-185 74180-65  
7416-25 7490-42 74177-75  
7417-25 7491-53 74181-190  
7420-14 7492-43 74190-100  
7425-25 7493-45 74191-100  
7426-22 7494-70 74192-83  
7427-25 7495-69 74193-83  
7430-14 7496-65 74194-85  
7432-25 74107-28 74195-52  
7437-21 74121-33 74257-125  
7438-21 74123-65 74279-87  
7440-14 74125-40 75324-175  
7441-70 74126-40 75491-65  
7442-40 74132-67 75492-65

### MINIATURE DIP SWITCHES

CTS-206-4 Four SPST switches in one mini dip package. \$1.75  
CTS-206-8 Eight SPST switches in a 16 pin DIP package. \$1.95

5-BV SPST Miniature feed relay, normally open, 330 Ohm coil resistance \$75, 3/2.00  
ALCO MINIATURE TOGGLE SWITCHES  
MTA 110 SPDT \$1.20  
MTA 206 DPDT \$1.70

### Full Wave Bridges

PRV	2A	6A	25A
200	75	1.25	2.00
400	95	1.50	3.00
600	1.20	1.75	4.00

**SANKEN AUDIO POWER AMPS**  
Si 1010 G 10 WATTS \$ 7.95  
Si 1020 G 20 WATTS \$ 15.95  
Si 1050 G 50 WATTS \$ 27.95

### TANTALUM CAPACITORS

22UF 35V 5/S 1.00	6.8UF 35V 3/S 1.00
47UF 35V 5/S 1.00	22UF 35V \$ .40
68UF 35V 5/S 1.00	30UF 6V 5/S 1.00
1UF 35V 5/S 1.00	33UF 75V \$ .40
2.2UF 20V 5/S 1.00	47UF 20V \$ .35
3.3UF 35V 4/S 1.00	68 UF 15V \$ .50
4.7UF 15V 5/S 1.00	10 UF 25V \$ .25

M7001 ALARM CLOCK CHIP \$5.75

### 74LS SERIES LINEAR CIRCUITS

74LS00	23	74LS153	93	LM 308	-95
74LS02	23	74LS155	140	LM 311	-95
74LS04	28	74LS157	98	LM 318	-35
74LS08	23	74LS160	102	LM 319	-95
74LS10	23	74LS161	102	LM 324	-95
74LS11	23	74LS162	102	LM 329	-10
74LS13	50	74LS163	102	LM 370	1.15
74LS20	23	74LS168	110	LM 377	-2.50
74LS21	23	74LS169	110	LM 380	-95
74LS22	23	74LS173	139	LM 381	-1.25
74LS27	27	74LS174	105	LM 382	-1.25
74LS30	23	74LS175	122	LM 537	-2.50
74LS32	33	74LS190	150	LM 553	-2.50
74LS37	37	74LS191	150	LM 555	-44
74LS38	37	74LS192	175	LM 556	-85
74LS74	49	74LS193	175		
74LS90	95	74LS195	125	560	-2.00
74LS42	88	74LS196	99	565	-1.10
74LS73	40	74LS197	99	566	-1.50
74LS74	40	74LS257	135	567	-1.50
74LS76	40	74LS258	138	703	-90
74LS90	89	74LS266	38	709	-25
74LS92	85	74LS268	66	710	-35
74LS93	85	74LS269	66	711	-35
74LS109	50	74LS267	66	714 C or V	-31
74LS112	43	74LS268	66	747	-65
74LS113	43	74LS390	220	LM1310	2.50
74LS114	43			1456	-95
74LS132	80			1458	-60
74LS138	72			CA 3046	-75
74LS139	72	LM 101	-75	3900	-49
74LS145	15	LM 301/748	-31	8038CC	-3.90
74LS151	98	LM 307	30		

### LINEAR CIRCUITS

PRV 1A	10A	25A	1.5A	6A	35A
100	40	1.30	40	50	1.20
200	70	1.10	1.75	60	70
400	1.10	1.60	2.60	1.00	1.20
600	1.70	2.30	3.60	1.50	3.00

### TRIACS SCR'S

100 40 1.30 40 50 1.20  
200 70 1.10 1.75 60 70 1.60  
400 1.10 1.60 2.60 1.00 1.20 2.60  
600 1.70 2.30 3.60 1.50 3.00

## SOLID STATE SALES

P.O. BOX 74A  
SOMERVILLE, MASS. 02143 TEL. (617) 547-4005

WE SHIP OVER 95% OF OUR ORDERS THE DAY WE RECEIVE THEM

7400 TTL					5400 SERIES					MOTOROLA CIRCUITS					JAPANESE CIRCUITS							
7400	21	7442	108	74121	55	5400 100	5475	150		MC725P	150	MC1741CG	98	AN136	2 90	HA1312	4 05	STK056	11 35	TA7201P	6 40	
7401	21	7448	115	74122	49	5404 125	5486	190		MC740L	155	MC1806P	98	AN203	3 75	HA1322	5 20	STK415	11 50	TA7203P	7 00	
7402	21	7450	26	74123	105	5410 100	5493	200		MC790P	150	MC1810P	98	AN210	3 10	LA1201	4 25	TA7054P	3 05	TA7205P	6 50	
7404	21	7451	27	74124	60	5426 125	54100	180		MC832P	48	MC2053L	45	AN211	3 30	LA1364	4 25	TA7055P	5 50	TA78005M	2 50	
7405	24	7453	27	74126	81	5473 150	54LS04	100		MC1000L	125	MC3004L	132	AN212	4 90	LA1366	6 00	TA7061P	2 25	TA78012M	2 50	
7406	45	7454	41	74132	300					MC1008L	125	MC3006P	144	AN213	3 30	LA3301	4 85	TA7149P	4 40	TA78012P	1 95	
7407	45	7460	22	74141	115					MC1010L	125	MC3007P	132	AN234	5 75	LA4030	4 85	TA7063P	2 25	TA78015M	2 50	
7408	25	7472	39	74150	110					MC1011L	125	MC3021L	2 15	AN239	6 50	LA4031P	3 50	TA7074P	4 25	TA78015P	1 95	
7409	25	7473	45	74151	125					MC1037L	12 50	MC3060L	2 65	AN241	3 20	LA4051P	4 65	TA7075P	4 40	TC9100P	12 00	
7410	20	7474	45	74153	135					MC1352P	1 05	MC3062L	3 00	AN245	6 50	TBA8105	1 50	TA7076P	4 55	UPC16C	2 50	
7411	30	7475	80	74154	125					MC1406CP	3 95	MC4024P	2 20	AN274	3 95	LD308U	4 00	TA7089P	2 90	UPC20C	5 00	
7413	85	7482	175	74155	121					MC1468L	2 90	MC14501CP	31	AN277B	3 40	LD3120	3 10	TA7102	5 15	UPC41C	3 95	
7416	43	7483	115	74157	130					MC1469P	2 50	MC14502CP	-18	AN288	4 80	LD314T	2 40	TA7120P	2 20	UPC554C	3 90	
7417	43	7485	112	74161	145					MC1510G	8 00	MC14507CP	82	AN328	4 05	M5112	5 40	TA7120P	2 20	UPC563H2	8 00	
7422	150	7489	249	74165	165					MC1514L	4 50	MC14510CP	2 40	AN343	3 90	M5155PR	4 80	TA7120P-C	2 20	UPC563H2	3 90	
7425	43	7490	69	74166	170					MC1550G	1 50	MC14511CP	2 40	BA511	3 50	M5155	2 85	TA7122P	2 30	UPC566H	2 25	
7427	37	7491	120	74174	95					MC1558	4 37	MC14512CP	-92	BA521	3 95	SG613	5 40	TA7124P	1 85	UPC575C	4 20	
7428	33	7492	82	74175	195					MC1558L	6 25	MC14519CG	94	HA1158	6 30	STK011	6 50	TA7146P	4 10	UPC101H2	5 15	
7430	26	7493	82	74180	105					MC1596G	3 31	MC14528CP	174	HA1159	6 60	STK015	10 50	TA7150P	4 55	UPC1020H	5 50	
7432	31	7494	91	74181	355					MC1723CG	1 25	MC4044P	4 80	HA1202	3 10	STK025	12 50	TA7153P	6 90	UPC1025	5 50	
7437	47	7495	91	74191	1 50									HA1306W	5 20	STK032	14 20	TA7200P	6 25			
7438	40	7496	91	74195	1 00																	
7440	21	74100	1 25	74197	1 30																	
7441	110	74107	49	74298	1 30																	

**74L SERIES TTL**

74L00	33	74LS04	45	74LS113	98
74L10	33	74LS10	39	74LS138	1 89
74L30	33	74LS20	39	74LS174	2 50
74L42	1 50	74LS51	39	74LS386	5 50
74L86	69	74LS74	65	74LS153	2 25
74LS00	39	74LS112	65	74LS387	1 95

**74H00 TTL**

74H00	33	74H11	33	74H53	39
74H10	33	74H20	33	74H55	39
74H40	33	74H21	33	74H73	59
74H05	35	74H30	33	74H74	59
74H10	33	74H40	33	74H76	60

**ELECTROLYTIC CAPACITORS**

2 2MF50	AXIAL LEADS	15
3 3MF10	AXIAL LEADS	15
3 3MF10	NO POLARITY	15
10MF25	AXIAL LEADS	15
10MF50	AXIAL LEADS	15
10MF150	AXIAL LEADS	20
25MF35	AXIAL LEADS	15
30MF25	AXIAL LEADS	15
47MF25	RADIAL LEADS	15
47MF50	RADIAL LEADS	20
100MF16	RADIAL LEADS	15
100MF25	RADIAL LEADS	20
500MF50	AXIAL LEADS	60
1000MF35	AXIAL LEADS	65

**MISC CIRCUITS**

BC184L	60	LM309K	1 95	SN15844N	55
CA3001	75	LM351AN	70	SN15946	55
CA3005	80	LM741CP	40	SN158097N	60
CA3006	1 10	LM1458M	65	SN72560P	4 50
CA3018	1 60	MFG9020	1 15	SN727410N	85
CA3018A	1 60	MR995A	1 05	SN72741C	49
CA3026	2 15	MSC9967P1	50	SN7274BP	95
CA3035	2 45	N5558	55	UA703C	40
CA3039	1 35	N5558B	5 00	UA709C	40
CA3058	1 90	N5555V	45	UFS773393	2 40
CA3070P	45	PA771131	45	95879	6 50
C5134J	1 15	PL994551	45	966079	12 50
C5135J	1 20	RC14370B	35	99879	9 00
C5136	1 25	SC9962P	70	936-50	1 10
(C3)(GE)	1 50	SC9966P	1 25	9313DC	1 20
LM301AN	35	SN15830N	50	93L28DC	2 75

**POSITIVE VOLTAGE REGULATORS**

LM340K-5	1 95
LM340K-6	1 95
LM340K-8	1 95
LM340K-12	1 95
LM340K-15	1 95
LM340K-18	1 95
LM340K-24	1 95
LM340T0-5	1 75
LM340T0-6	1 75
LM340T0-8	1 75
LM340T0-12	1 75
LM340T0-15	1 75
LM340T0-18	1 75
LM340T0-24	1 75

**IC'S ON THE MOVE**

BBD BUCKET BRIGADE DEVICE					
MM3001	19 50	MM3002	11 70	MM3003	9 45
HALL IC	DN834	1 25	DN837	1 50	
	DN835	1 35	DN838(NEW)		
SN76001	1 75	SN76002	1 95		
PLL02A	MIDLAND PHASE LOCK LOOP				12 00

**MICROPROCESSOR CHIPS**

1404A	3 25	2102	2 50	MM5013	3 25
C1702A	19 95	C2708	95 00	8008	19 95
2101	6 95	CA702A	19 95	80B0A	29 95
MK200 P-11	4096x1 Bit Dynamic Ram				9 95
C5101-3	1024 Bit (256x4) Static C-Mos Ram				4 50
MC14514	4 Bit Latch 4 to 16 Line Decoder				4 25

CALL OR WRITE FOR FURTHER INFORMATION. SPEC'S AVAILABLE

**HOBBY SPECIALS**

Power Pac	100 Asst (includes Case T03, T066 T0220, T0202)	\$2 99
Transistor/Diode Pac	100 Asst (includes Case T05, T039, T018, D07, 0041)	\$1 99
I C Pac	50 Asst (includes 14 & 16 Pin)	\$3 50
Resistor Pac	50 Asst (Assorted values)	\$1 50
Mos Fet Pac	10 Asst (many top #'s Case T072)	\$0 99
SCR Pac	100 Asst (similar to C103 Series) Case to 92. VR 10-100V, 1 4000MA IGT-200MA	\$4 00

**ZENER DIODES**  
1/2 & 1 Watt 10% .30 each UP TO 33V.  
GREATER THAN 33V CALL FOR PRICING.

**PAGE/PATHCOM PART #'S**

130079	4 00	IP20-0123	2 75
1300821	65	IP20-0131	2 50
13-0122	1 75	IP20-0141	3 00
83-0005	2 00	IP20-0142	3 00
83-0007	2 50	IP20-0139	4 30
83-0008	2 00	IP20-0154	6 00
83-0015	3 00	IP20-0155	2 50
IP20-0005	3 00	IP20-0161	4 00
IP20-0016	4 00	IP20-0177	2 50
IP20-0034	85	IP20-0176	2 85
IP20-0045	2 00	IP20-0191	.72
IP20-0073	2 75		
IP20-0093	2 50		

**JAPANESE TRANSISTORS \* CB, AUDIO, INDUSTRIAL**

2SA52	60	2SC206	1 00	2SC774	1 75	2SC1173	95	2SD77	1 00
2SA316	75	2SC240	1 10	2SC775	2 75	2SC1175	65	2SD81	3 25
2SA473	75	2SC291	65	2SC776	3 00	2SC1209	55	2SD88	1 10
2SA483	1 85	2SC292	3 00	2SC777	4 00	2SC1213	1 75	2SD118	3 25
2SA489	80	2SC320	75	2SC778	4 00	2SC1226A	1 25	2SD130	1 25
2SA490	70	2SC352	75	2SC781	3 00	2SC1237	4 50	2SD141	2 25
2SA505	70	2SC353	75	2SC783	1 00	2SC1239	4 00	2SD151	2 25
2SA564	50	2SC371	70	2SC784	70	2SC1243	1 50	2SD170	2 00
2SA628	65	2SC372	70	2SC785	1 00	2SC1293	85	2SD180	2 75
2SA643	85	2SC394	70	2SC789	1 00	2SC1306	4 75	2SD201	1 95
2SA647	2 75	2SC458	70	2SC793	2 50	2SC1307	5 75	2SD218	1 95
2SA673	85	2SC460	70	2SC796	3 15	2SC1308	4 75	2SD235	1 00
2SA679	3 75	2SC478	80	2SC797	3 10	2SC1318	7 00	2SD300	2 50
2SA682	85	2SC481	80	2SC799	3 15	2SC1319	7 00	2SD313	1 10
2SA689	1 30	2SC482	1 75	2SC809	4 25	2SC1325	4 95	2SD315	7 5
2SA698A	1 45	2SC491	2 50	2SC802	3 75	2SC1327	7 00	2SD316	2 50
2SA705	55	2SC495	1 10	2SC803	4 00	2SC1338	1 75	2SD317	1 25
2SA815	85	2SC497	1 60	2SC815	7 00	2SC1346	80	2SD318	95
2SA816	85	2SC502	1 50	2SC828	75	2SC1347	80	2SD325	1 25
		2SC515	80	2SC829	75	2SC1364	1 50	2SD341	95
		2SC822	4 25	2SC830	1 60	2SC1377	5 50	2SD350	1 25
		2SC854	75	2SC838	70	2SC1383	75	2SD352	8 0
		2SC856	70	2SC839	85	2SC1384	85	2SD380	5 70
		2SC871	70	2SC892	55	2SC1409	1 25	2SD389	7 5
		2SB128	2 25	2SC563	2 50	2SC1410	1 25	2SD390	75
		2SB152	4 50	2SC607	1 25	2SC1447	1		

# GODBOUT

BILL GODBOUT ELECTRONICS  
BOX 2355, OAKLAND AIRPORT, CA 94614

TERMS: Add 50¢ orders under \$10. Allow up to 5% for shipping; excess refunded. We require street address for COD orders. BankAmericard/Mastercharge (\$15 minimum) call 415-562-0636, 24 hrs. Cal res add tax.

## It's Unanimous: "Electronic Projects For Musicians" IS A HIT!

By CRAIG ANDERTON \$6.95 ppd USA

This book has helped thousands build their own exciting and innovative music projects... 19 in all. But listen to what the magazines say... 75: "a dandy book... fantastic music gadgets!" Popular Electronics: "gets it all together" Electronics: "highly recommended... it gives the essential information" Synapse: "a clear understanding of the needs of electronic musicians not met in other books of this kind" Byte: "Even if you couldn't care less about musical applications, you can use this book" Polyphony: "terrific illustrations... an excellent introduction". 134 pages, with demonstration soundsheet and forward by guitarist Joe Walsh.

PARTS KITS AVAILABLE FOR MOST PROJECTS; WRITE FOR INFO.

## MUSIC KITS!

In addition to the book projects, Craig has introduced several more projects in his Guitar Player magazine column. We offer parts kits that include all electronic components, IC socket(s), quality circuit boards, pots, and instructions; builder supplies case, jacks, switches, and other mechanical items.

**10 DAY OPTION:** Look your kit over for 10 days; if for any reason you feel the kit does not suit your purposes, return it unassembled for prompt refund.

### Phase Shifter \$39.95

Four stage, 720° shifter. Wide-range speed control, plus depth and volume. Voltage regulator aids battery life.

### REYERB UNIT \$12.50

Plugs between guitar and amp to give concert hall effects. Springs not included but are readily available.

### Talking Box \$19.95

Low power, self-contained unit does not require separate amp. Includes fuzz to add harmonics and increase sustain with guitar. Requires about \$20 of extra parts.

### THE TUBE SOUND FUZZ \$19.95

Imitates FET distortion elements to mimic the type of distortion generated by vacuum tubes. Uses one 9 Volt battery.

### Bi-Filter FOLLOWER \$29.50

Uses 2 filters tuned about an octave apart in conjunction with an envelope follower to give synthesizer-like automatic wa effects. Low noise. May be modified for bass.

CIRCLE NO. 22 ON FREE INFORMATION CARD

## BUSINESS OPPORTUNITIES

I MADE \$40,000.00 Year by Mailorder! Helped others make money! Free Proof. Torrey, Box 318-NN, Ypsilanti, Michigan 48197.

FREE CATALOGS. Repair air conditioning, refrigeration. Tools, supplies, full instructions. Doolin, 2016 Canton, Dallas, Texas 75201.

MAILORDER MILLIONAIRE helps beginners make \$500 weekly. Free report reveals secret plan! Executive (1K8), 333 North Michigan, Chicago 60601.

GET RICH with Secret Law that smashes debts and brings you \$500 to \$5 Million cash. Free report! Credit 4K8, 333 North Michigan, Chicago 60601.

## HIGHLY PROFITABLE ONE-MAN ELECTRONIC FACTORY

Investment unnecessary, knowledge not required, sales handled by professionals. Postcard brings facts about this unusual opportunity. Write today! Barta-DV, Box 248, Walnut Creek, CA 94597.

HOW TO MAKE \$2,000 WEEKLY at home using other people's money. Guaranteed. Free Details. Richlieu, Box 25357, Dept. F8, Houston 77005.

NEW LUXURY Car Without Cost. Free Details! Codex-ZZ, Box 6073, Toledo, Ohio 43614.

\$500/THOUSAND IMMEDIATELY. Stuffing envelopes, free supplies, rush stamped, addressed envelope. SALAMON INDUSTRIES, 6059 W. 55th Street, Chicago, Ill. 60638.

HIGH EARNINGS from mailorder privately. Step-by-step details. \$500+ per month. \$3. Adver-Serv, Box 5231, Akron, Ohio 44313.

FANTASTIC mailing program brings huge profits fast! Also, sources of free mailing lists. Send \$1.00 and SASE No. 10 to Gray, Box 1752-MA, Fort Smith, AR 72902.

MECHANICALLY Inclined individuals desiring ownership of Small Electronics Manufacturing Business — without investments. Write: Marks, 92-K8 Brighton 11th, Brooklyn, New York 11235.

HOW TO BORROW \$25,000 interest-free!... Indefinitely! Free Report: Executive-PEB, Box 368, Buford, Georgia 30518.

For faster service

USE ZIP CODE on all mail



### SIX DIGIT 12/24 HR. CLOCK KIT \$22.95 MODEL DC-5

The best looking, most complete kit on the market! Features include: time set pushbuttons, jumbo 4" readouts, Polaroid lens filter, fine cord transformer, super quality PC boards and durable extruded aluminum case available in five different colors. All parts are included, there are no extras needed! Super instructions reduce assembly time to 1-2 hours. Fully guaranteed. Colors available: gold, silver, bronze, blue and black (specify).

Clock Kit, DC-5 \$22.95  
Alarm Clock Version, DC-8 \$24.95  
12/24 Hr. Clock with 10-Minute ID Timer, DC-10 \$25.95

Assembled & tested version add \$10 to kit price.

### VIDEO TERMINAL KIT \$149.95

A compact 5 x 10-inch PC card that requires only an ASCII keyboard and a TV set to become a complete interactive terminal for connection to your microprocessor. asynchronous interface. Its many features are: single 5-volt supply crystal controlled sync and baud rates (up to 9600 baud). 2 pages of 32 characters by 16 lines; read to and from memory; computer and keyboard-operated cursor and page control; parity error display and control; power-on initialization; full 64-character ASCII display; block-type see-thru cursor; Keyboard/Computer control backspaces; forward spaces, line feeds, rev. line feeds, home, returns cursor. Also clears page, clears to end of line, selects page 1 or 2; reads from or to memory. The card requires 5 volts at approx. 900 ma and outputs standard 75 ohm composite video.

TH3216 Kit \$149.95  
TH3216, Assembled and Tested \$239.95  
VD-1, Video to RF Modulator Kit \$ 6.95

## MINI-KITS

**FM WIRELESS MIKE KIT**  
FM-1 \$2.95  
Transmits up to 300' to any FM radio. Sometimes mike input requires dynamic crystal or ceramic mike. Runs on 3 to 9 volts.

**TO NE DECODER KIT**  
A complete tone decoder on a single PC Board. Features: 500 to 3000 Hz adjust; 257 Hz. frequency range; voltage regulation; IC. Useful for touch tone decoding. Note: burst detection; FSK demod; sig. sense; and many other features. Use for 12 button touchtone decoding. Runs on 3 to 12 volts.  
Complete Kit, TD-1 \$4.95

**LED BLINKY KIT**  
A great attention getter, which alternately flashes 2 jumbo LEDs. Use for name boards, buttons on warning type panel lights.  
Complete Kit, BL-1 \$2.95

**SUPER-SNOOP AMPLIFIER**  
A super-sensitive amplifier which will pick up a snore drop 15' away. 2000 Hz monitoring baby's room or as a general purpose test amplifier. Full 2 watts of output; runs on 5 to 12 volts; uses any type of msa. Requires 845 ohm speaker.  
Complete Kit, BN-9 \$4.95

**MUSIC LIGHTS KIT**  
See music come alive! 3 different lights flash with music of choice. One light for each channel and one for overall intensity. Available and drives up to 300 watts. Includes parts, build music, mite kits and more.  
Complete Kit, ML-1 \$7.95

**SIREN KIT**  
Produces upward and downward wail characteristics. 13 Hz. 15' range. 2000 Hz. audio output; runs on 3V volts; uses 845 ohm speaker.  
Complete Kit, SM-3 \$2.95

**CODE OSCILLATOR KIT**  
Powerful 1 watt audio oscillator of approx. 1 kHz. good for many uses. Great for warming, alarm, battery checker, voltage indicator, code oscillator.  
Complete Kit, CPO-1 \$2.50

**POWER SUPPLY KIT**  
Complete triple regulated power supply provides variable 1.5 volts at 200ma and 4.5 volts at 1 amp. 500V load regulation; good filtering and small size. Kit has 10% transformer; requires 845 ohm 1 amp and 18 to 30VCT.  
Complete Kit, PS-3LT \$6.95

**DECADE COUNTER PARTS KIT**  
Includes 74108 10 MHz counter; 7475 latch; 7447 LED driver; LED readout; full instructions on how to build an easy-to-use Kit of Parts, DCU-1 \$3.50

### CAR CLOCK KIT 6-Digit 12/24 HR.

- High Accuracy (1 Min / Month)
- Big, 4" high readout
- Special circuit suppresses all spikes and transients
- Same case as DC-5 above
- Displays blanks with ignition

\$25.95

Assembled & tested version add \$10 to kit price.

### CALENDAR ALARM CLOCK KIT 6-Digit 12/24 Hour

Has every feature one could ever ask for. Kit includes all parts except case, build it into wall, station or even car! Uses the incredible 7001 chip. Features:  
• 6-digit 5" high  
• Calendar shows mo./day  
• 24-Hour alarm with snooze  
• 12- or 24-Hr. Format  
• Battery backup with on-chip time base  
Complete Kit, less case, DC-9 \$34.95

### CAR CLOCK KIT \$27.95

- 12/24-Hour 12-Volt AC or DC
- High Accuracy (1 minute/month)
- 6 jumbo 4" LED readouts
- Easy, no-polarity hookup
- Display blanks with ignition
- Case, mounting bracket included
- Super instructions

Complete Kit, DC-11 \$27.95  
Assembled & tested version add \$10 to kit price.



**AUTO-DIMMER \$3.50**  
Automatic dimmer, reduces brightness of clock display to prevent glare. For use with any clock.

### 600 MHz Prescaler \$59.95

Fully assembled and tested. Extend the range of your counter to 10 times higher in frequency. Works with any counter. High sensitivity input with built-in on-chip pre-amp.  
PS-1B, 10 \$59.95



### 741 OP-AMP Factory prime minidip. House marked 10 for \$2.00



LINEAR		REGULATOR		TRANSISTORS	
555	.50	309K	.99	NPN 2N3904 type	10/\$1.00
556	.75	309H	.99	PNP 2N3906 type	10/\$1.00
567	1.75	340K-12	.99	NPN Power Tab 40W	3/\$1.00
1458	.65	7805	.99	PNP Power Tab 40W	3/\$1.00
		7812	.99	FET MPF-102 type	3/\$2.00
		7815	.99	UJT 2M2646 type	3/\$2.00
		7818	.99	2N3055 NPN Power	

### MA-1003A CAR CLOCK MODULE \$23.95 MA-1002A ALARM CLOCK MODULE \$12.95

Includes transformer and switches. Auto dimmer photocell for use with 1002 \$ 75

## ramsay electronics

P.O. BOX 4072 ROCHESTER, N.Y. 14610

Telephone Orders Welcome

(716) 271-6487



Satisfaction guaranteed or money refunded. C.O.D. orders add \$1.00. Orders under \$10.00 add \$ 75. N.Y. residents add 7% sales tax. Foreign orders add 20% for Air Mail Shipment.

NEW LSI TECHNOLOGY  
**FREQUENCY COUNTER**

TAKE ADVANTAGE OF THIS NEW STATE-OF-THE-ART COUNTER FEATURING THE MANY BENEFITS OF CUSTOM LSI CIRCUITRY. THIS NEW TECHNOLOGY APPROACH TO INSTRUMENTATION YIELDS ENHANCED PERFORMANCE, SMALLER PHYSICAL SIZE, DRASTICALLY REDUCED POWER CONSUMPTION [PORTABLE BATTERY OPERATION IS NOW PRACTICAL], DEPENDABILITY, EASY ASSEMBLY AND REVOLUTIONARY LOWER PRICING!

SIZE:  
3" High  
6" Wide  
5 1/2" Deep

1 1/4 LBS.  
COLOR:  
BLACK



4" DIGITS!

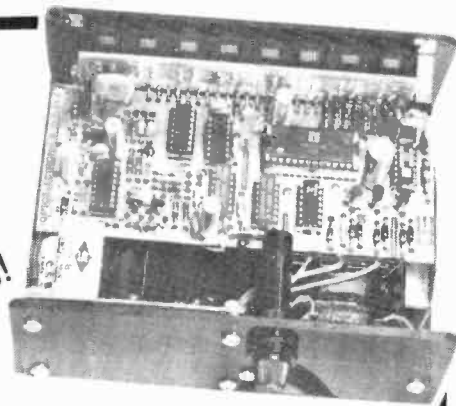

FEATURES AND SPECIFICATIONS:

DISPLAY: 8 RED LED DIGITS .4" CHARACTER HEIGHT  
GATE TIMES: 1 SECOND AND 1/10 SECOND  
[AUTO DEC. PT. PLACEMENT]  
RESOLUTION: 1 HZ AT 1 SECOND, 10 HZ AT 1/10 SECOND.  
FREQUENCY RANGE: 10 HZ TO 60 MHZ [65 MHZ TYPICAL].  
SENSITIVITY: 10 MV RMS TO 50 MHZ, 20 MV RMS TO 60 MHZ TYP.  
INPUT IMPEDANCE: 1 MEGOHM AND 20 PF  
[DIODE PROTECTED INPUT FOR OVER VOLTAGE PROTECTION.]  
ACCURACY: ± 1 PPM [± .0001%] AFTER CALIBRATION TYPICAL  
STABILITY: WITHIN 1 PPM PER HOUR AFTER WARM UP [0.01% XTAL  
IC PACKAGE COUNT: 8 [ALL SOCKETED]  
INTERNAL POWER SUPPLY: 5.2 V DC AT 800 MA REGULATED  
INPUT POWER REQUIRED: 8-12 V DC OR 115 VAC AT 50/60 HZ.  
POWER CONSUMPTION: 4 WATTS  
INPUT CONNECTOR: BNC TYPE

FACTORY DIRECT PRICES

KIT #FC-50C	60 MHZ COUNTER WITH CABINET & P.S.	\$99.85
KIT #PSL-350	350 MHZ PRESCALER [NOT SHOWN]	23.95
KIT #PSL-650	650 MHZ PRESCALER [NOT SHOWN]	29.95
MODEL #FC-50WT	60 MHZ COUNTER WIRED, TESTED & CAL.	165.95
MODEL #FC-50/600WT	600 MHZ COUNTER WIRED, TESTED & CAL.	199.95

KIT #FC-50C IS COMPLETE WITH PREDRILLED CHASSIS ALL HARDWARE AND STEP-BY-STEP INSTRUCTIONS. WIRED & TESTED UNITS ARE CALIBRATED AND GUARANTEED. PRESCALERS WILL FIT INSIDE COUNTER CABINET.

PLEXIGLAS CABINETS

Great for Clocks or any LED Digital project Clear-Red Chassis serves as Bezel to increase contrast of digital displays.

<b>CABINET I</b> 3"H, 6 1/2"W, 5 1/2"D	Black, White or Clear Cover	
<b>CABINET II</b> 2 1/2"H, 5"W, 4"D		\$6.50 ea.
RED OR GREY PLEXIGLAS FOR DIGITAL BEZELS		95¢ ea. 4/83

SEE THE WORKS Clock Kit  
Clear Plexiglas Stand

- 6 Big 4" digits
- 12 or 24 hr. time
- 3 set switches
- Plug transformer
- all parts included

Plexiglas is Pre-cut & drilled  
Kit #850-4CP

Size: 6"H, 4 1/2"W, 3"D  
\$23.50 ea. 2/45.

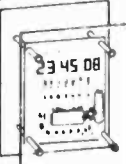

A SUPER CLOCK!

60 HZ.

XTAL TIME BASE  
Will enable Digital Clock Kits or Clock-Calendar Kits to operate from 12V DC.  
1"x2" PC Board  
Power Req. 5-15V (2.5 MA TYP.)  
Easy 3 wire hookup  
Accuracy ± 2PPM  
#TB-1 (Adjustable)  
Complete Kit \$4.95  
Wir & Cal \$9.95

SPECIAL PRICING!  
PRIME - HIGH SPEED RAM

**21L02-3** 400 NS

LOW POWER - FACTORY FRESH

1-24	\$1.95 ea.	100-199	\$1.60 ea.
25-99	1.75 ea.	200-499	1.45 ea.

OVER 500 PCS. \$1.39 ea.

6-DIGIT LED CLOCK CALENDAR KIT  
DATE-TIME-SNOOZE ALARM & MORE... KIT 7001

FOR THE BUILDER THAT WANTS THE BEST. FEATURING 12 OR 24 HOUR TIME — 29-30-31 DAY CALENDAR. ALARM, SNOOZE AND AUX. TIMER CIRCUITS

Will alternate time (8 seconds) and date (2 seconds) or may be wired for time or date display only, with other functions on demand. Has built-in oscillator for battery back-up. A loud 24 hour alarm with a repeatable 10 minute snooze alarm, alarm set & timer set indicators. Includes 110 VAC/60Hz power pack with cord and top quality components through-out.

KIT - 7001B WITH 6 - 5" DIGITS	\$39.95
KIT - 7001C WITH 4 - 6" DIGITS & 2 - 3" DIGITS FOR SECONDS	\$42.95
KIT - 7001X WITH 6 - 6" DIGITS	\$45.95

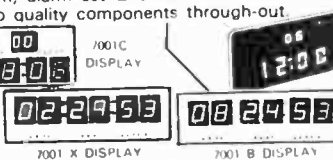

KITS ARE COMPLETE (LESS CABINET)

ALL 7001 KITS FIT CABINET I AND ACCEPT QUARTZ CRYSTAL TIME BASE KIT # TB-1

PRINTED CIRCUIT BOARDS for CT 7001 Kits sold separately with assembly info. PC Boards are drilled Fiberglass, solder plated and screened with component layout.

Specify for 7001

B, C or X - \$ 7.95

AUTO BURGLAR ALARM KIT

AN EASY TO ASSEMBLE AND EASY TO INSTALL ALARM PROVIDING MANY FEATURES NOT NORMALLY FOUND KEYLESS ALARM HAS PROVISION FOR POS & GROUNDING SWITCHES OR SENSORS WILL PULSE HORN RELAY AT 1HZ RATE OR DRIVE SIREN KIT PROVIDES PROGRAMMABLE TIME DELAYS FOR EXIT ENTRY & ALARM PERIOD UNIT MOUNTS UNDER DASH - REMOTE SWITCH CAN BE MOUNTED WHERE DESIRED CWO'S RELIABILITY RESISTS FALSE ALARMS & PROVIDES FOR ULTRA DEPENDABLE ALARM DO NOT BE FOOLED BY LOW PRICES! THIS IS A TOP QUALITY COMPLETE KIT WITH ALL PARTS INCLUDING DETAILED DRAWINGS AND INSTRUCTIONS OR AVAILABLE WIRED AND TESTED



KIT #ALR-1 \$9.95  
#ALR-1WT WIRED & TESTED \$19.95

VARIABLE REGULATED 1 AMP POWER SUPPLY KIT

- VARIABLE FROM 4 TO 14V
- SHORT CIRCUIT PROOF
- 723 IC REGULATOR
- 2N3055 PASS TRANSISTOR
- CURRENT LIMITING AT 1 Amp
- KIT IS COMPLETE INCLUDING DRILLED & SOLDER PLATED FIBERGLASS PC BOARD AND ALL PARTS (LESS TRANSFORMER) KIT #PS-01 \$8.95
- TRANSFORMER 24V CT will provide 300MA at 12V and 1 Amp at 5V. \$3.50

MOBILE LED CLOCK

12/24 HR 4" DIGITS!

MODEL #2001 12 VOLT AC or DC POWERED



- 6 JUMBO 4" RED LED'S BEHIND RED FILTER LENS WITH CHROME RIM
- SET TIME FROM FRONT VIA HIDDEN SWITCHES • 12/24-Hr. TIME FORMAT
- STYLISH CHARCOAL GRAY CASE OF MOLDED HIGH TEMP. PLASTIC
- BRIDGE POWER INPUT CIRCUITRY — TWO WIRE NO POLARITY HOOK-UP
- OPTIONAL CONNECTION TO BLANK DISPLAY [Use When Key Off in Car, Etc.]
- TOP QUALITY PC BOARDS & COMPONENTS - INSTRUCTIONS.
- MOUNTING BRACKET INCLUDED

KIT #2001 COMPLETE KIT (Less 9V. Battery) \$29.95 3 OR MORE \$27.95 EA. MORE  
115 VAC Power Pack #AC-1 \$2.50 EA. MORE  
ASSEMBLED UNITS WIRED & TESTED ORDER #2001 WT (LESS 9V. BATTERY) \$39.95 3 OR MORE \$37.95 EA. MORE  
Wired for 12-Hr. Op. if not otherwise specified

OPTOELECTRONICS, INC.

BOX 219 • HOLLYWOOD, FLA. 33022 • (305) 921-2056  
STORE: 823 S. 21 AVE

WE PAY ALL SHIPPING IN CONTINENTAL USA — OTHERS ADD 5% [10% FOR AIRMAIL]

Master Charge

Master Charge

ORDER BY PHONE OR MAIL  
COD ORDERS WELCOME

Orders Under \$15 Add \$1.00 Handling  
Fla. Res. Please Add 4% Sales Tax



# INSTRUCTION

LEARN ELECTRONIC ORGAN SERVICING at home all makes including transistor. Experimental kit—troubleshooting. Accredited NHSC, Free Booklet. NILES BRYANT SCHOOL, 3631 Stockton, Dept. A, Sacramento, Calif. 95820.

SCORE high on F.C.C. Exams... Over 300 questions and answers. Covers 3rd, 2nd, 1st and even Radar. Third and Second Test, \$14.50; First Class Test, \$15.00. All tests, \$26.50. R.E.I., Inc., Box 806, Sarasota, Fla. 33577.

UNIVERSITY DEGREES BY MAIL! Bachelors, Masters, Ph.D's. Free revealing details. Counseling, Box 317-PE8, Tustin, California 92680.

GET your Commercial FCC License. New Exams by author of successful published workbooks of FCC Practice Tests. 500 Questions Second Class, \$11.95; 200 First Class, \$7.95; 100 Radar, \$4.95; Postpaid. Save, all three \$19.95. Complete mathematical solutions. Free counselling service. Victor Veley, P.O. Box 14, La Verne, Calif. 91750.

SELF-STUDY CB RADIO REPAIR COURSE. THERE'S MONEY TO BE MADE REPAIRING CB RADIOS. This easy-to-learn course can prepare you for a career in electronics enabling you to earn as much as \$16.00 an hour in your spare time. For more information write: CB RADIO REPAIR COURSE, Dept. PE08, 531 N. Ann Arbor, Oklahoma City, Okla. 73127.

LEARN WHILE ASLEEP! HYPNOTIZE! Astonishing details, strange catalog free! Autosuggestion, Box 24-ZD, Olympia, Washington 98507.

GRANTHAM'S FCC LICENSE STUDY GUIDE — 377 pages, 1465 questions with answers/discussions — covering third, second, first radiotelephone examinations. \$13.45 postpaid. GSE, P.O. Box 25992, Los Angeles, California 90025.

INTENSIVE 5 week course for Broadcast Engineers. FCC First Class license. Student rooms at the school. Radio Engineering Inc., 61 N. Pineapple Ave., Sarasota, FL 33577 and 2402 Tidewater Trail, Fredericksburg, VA 22401.

LEARN BASIC Digital Troubleshooting by correspondence. Course includes text and demonstration modules. Educational Technologies, Box 224, Reynoldsburg, Ohio 43068.

HIGHLY EFFECTIVE Degree Program in Electronics Engineering. Advance rapidly! Our 31st Year. Free literature. Cook's Institute, Box 20345, Jackson, Miss. 39209.

1977 TESTS-ANSWERS for FCC First Class License. Plus "Self-Study Ability Test." Provent! \$9.95. Moneyback Guarantee. "FREE" BROCHURE. Command, Box 26348-P, San Francisco 94126.

# TAPE AND RECORDERS

RENT 4-Track open reel tapes—free brochure. Stereo-Parti, P.O. Box 7, Fulton, CA 95401.

8-TRACK and CASSETTE BELTS — money back guarantee. Long wearing. Free Catalog — \$3 minimum order. PRB Corp., Box 176, Whitewater, Wisconsin 53190.

REVOX A77 tape transport — new, factory boxed. Only \$399.00! Complete transport with servo capstan motor, power supply, transport relay board and capstan servo electronics. Needs only heads and audio circuitry to complete a professional quality tape recorder. Full schematics supplied with each unit. Send certified check or money order to assure immediate delivery, write or call for more details. (516) 921-2620. ESSI, P.O. Box 854, Hicksville, N.Y. 11802.

## INTERNATIONAL ELECTRONICS UNLIMITED

### SUMMER CLEARANCE SALE (GOOD THRU AUGUST)

MEMORIES		DIGITAL		LINEAR		SHIFT REGISTERS		LED DISPLAYS	
1101	\$6.9	7400	\$0.9	376 mDIP	\$4.9	2510	\$1.95	DL10A	\$1.49
1103	.69	7416	.29	739 DIP	.89	2511	1.49	NSN 74R	.99
1702A	5.95	7427	.24	1414 DIP	1.39	2522	1.95	FND 359	.59
2708	24.95	7437	.19	75453 mDIP	.29	5016	1.19	MAN 5	.99
5262	.99	7454	.12	75491 DIP	.59				
74S200	3.25	7493	.39						
7489	1.75	7495	.69						
82S23	2.75	74145	.89						
93410	1.39	9602	.59						
		74C154	2.49						

#### SPECIAL SALE

**HP 8082-SERIES**  
MAG LENS FITS 14 PIN SOCKET  
5 DIGIT RED .11 CC RHD \$1.49  
4 DIGIT RED .11" CC RHD **\$ .57 ea.**

#### NO SHIPPING CHARGES IN U.S. AND CANADA (EXCEPT AS NOTED)

CENTRAL PROCESSING UNIT	
8008	\$16.95
8080A	\$19.95

2102	
1024X1 STATIC RAM	16 PIN \$1.49

74S200	
256 BIT RAM TRI-STATE	\$3.25

1458	
DUAL OP AMP	\$3.39

UART	
AY51013A	\$6.95

SPECIAL DEVICES	
372 AF-IF Strip Detector DIP	2.93
546 AM Radio Receiver Subsystem DIP	.75
1310 FM Stereo Demodulator DIP	2.90
1496 Balanced Modulator-Demodulator	.99
1800 Stereo multiplexer DIP	2.48
LU2208 FM Gain Block 34db (typ) mDIP	1.18
LU2209 FM Gain Block 48db (typ) mDIP	1.35
2513 Character Generator 64x5 DIP-24	10.28
3046 Transistor Array DIP-14	.73

MM 5330	
4' DIGIT DVM LOGIC	\$6.95

LH 0070	
BCD BUFFERED REF.	\$6.95

LF 13300D	
DUAL SLOPE A/D	\$12.95
ANALOG BUILDING BLOCK	

MM 5616	
QUAD BI-LATERAL SWITCH	\$1.25

## Olson ELECTRONIC PARTS AND ACCESSORIES

SAVE 50%

BSR Smoke & GAS ALARM

1999 REG. 38.99

XM-646

LIMIT 2 • PROTECT YOUR FAMILY

**NICKEL CADMIUM "AA" Pen-Lite Cells**

• Rechargeable

BA-341 1 Ea. For radios, calculators, etc. 1.2 Volt.

Reg. Sale

Photo Elect. Camera Shutter, XM-637	1.49	1.00
Sperry 9 Digit Readout, XM-399	.89	.59
12 VDC Relay S.P.S.T., SW-854	1.49	1.00
12 VDC Relay D.P.S.T., SW-856	1.49	1.20
6 RP Day Timing Motor, 117 VAC., MO-407	1.69	1.20
60 Min. Cassette, Pkg. of 3, TA-879	1.49	.87
ZV. RED L.E.D., Pkg. of 5, PL-233	1.99	.59
40 Min. 8-Track Tape, TA-907	.69	.39
Elect. Cap. Kit, 50 Asst., CD-407	5.00	1.70
CB Converter for Car, CB-417	14.99	9.99
Resistors 1/2-watt, Pkg. 100, RR-077	1.79	.79
Volume Controls, 12 Asstd. VC-274	1.00	.49
Empire 999 Mag. Phono Cart. PC-188	9.99	6.99
3-6V DC Hobby Motors, 5 Asstd. MO-333	2.00	.59
Solder Terminal Strips, 40 Asstd. XM-501	1.30	.50
Double Face Foam Tape 1/2"x52", TA-903	1.00	.80
Tape Mailers, 3" Pkg. 5, TA-936	.79	.39
Ceramic Disc Cap., 100 Asstd. CC-210	1.29	.80
Knob Kit, 25 Pcs. Asstd., KN-030	1.00	.69
7 Seg. L.E.D. Display Com. K., XM-414	2.00	1.00
Z5B474 TO 66 Output Trans., TR-147	3.79	1.19

# Olson<sup>®</sup> electronics

260 S. FORGE ST.  
DEPT. 12 AKRON, OHIO 44327

NAME \_\_\_\_\_  
ADDRESS \_\_\_\_\_  
CITY \_\_\_\_\_ STATE \_\_\_\_\_  
ZIP \_\_\_\_\_  Send Olson Cat.  
ENCLOSE POSTAGE AND SALES TAX

110

CIRCLE NO. 25 ON FREE INFORMATION CARD

CIRCLE NO. 41 ON FREE INFORMATION CARD  
POPULAR ELECTRONICS

AmericanRadioHistory.Com

### TO-220 VOLTAGE REGULATOR FROM FAIRCHILD

7805C 5V	7815C 15V
7806C 6V	7818C 18V
7808C 8V	7824C 24V
7812C 12V	

2 for \$1.20

### CAPACITORS

#### 1% MICA 500V

51 PF .29	390 PF .50
62 PF .29	470 PF .50
75 PF .29	620 PF .52
82 PF .29	820 PF .53
100 PF .30	1000 PF .60
120 PF .32	1500 PF .60
150 PF .35	2000 PF .90
180 PF .41	2200 PF .94
220 PF .41	4700 PF 1.80
240 PF .46	5100 PF 1.80
300 PF .50	10000 PF 3.60

### FLUKE MODEL 8030A DIGITAL MULTIMETER



3 1/2 digit, six-function multimeter. Measurement functions include ac volts (true rms), dc volts, ac current (true rms), dc current, resistance, and diode test. Each function, except the diode test, is supplemented by 5 selectable ranges for a total of 26 ranges (one range for diode test).

\$250.00

OPTIONAL CASE \$20.00

### FIRST QUALITY ONLY PREMIUM QUALITY COMPONENTS SETS ANCRONA APART

SN75235N	1.10	MOS - RAM	
SN75238N	1.95	(C=CERAMIC) (P=PLASTIC) (DIP)	
SN75239N	1.50		
SN75235N	2.60		
SN75207N	3.30		
SN75208N	3.30		
DM8820N	2.00		
DM8820AN	2.95		
DM8830N	2.10		
DM8831N	7.50		
DM8832N	7.50		
DS8838N	2.95		
N8T26B	3.10		
33A1PC	1.65		
9602PC	2.90		

2048 BIT E-PROM  
C1702A 13.40  
C1702A-6 4.00

1024x8 BIT E-PROM  
C2708 33.50

### COMPUTER INTERFACE

MH0026CN	2.60	FIFO - MEMORY	
DS0056CN	5.85	2812DC	11.80
DS3063N	4.10	2813DC	19.50
MC1488L	1.90	2841DC	9.50
MC1489L	1.90	2841PC	8.25
MC1489AL	1.95	2812C	6.75
P3212	4.35	3341APC	6.75
P3216	3.90		
P3226	3.90		
DS3604N	6.65		
SN74123N	.95		
SN74LS123N	.49		
SN7422N	2.70		
SN7520N	1.55		
SN7525N	1.40		
SN75107N	1.90		
SN75108BN	1.70		
SN75109N	2.40		
SN75110N	2.40		
SN75234N	1.55		

### ALUMINUM ELECTROLYTIC

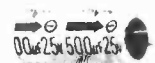

10V 10V 15V 25V 35V 50V

1	1.2	1.3	1.4	1.5	1.6
5	1.3	1.4	1.7	2.0	2.4
10	1.4	1.5	1.8	2.2	2.6
22	1.5	1.6	2.1	2.4	2.8
33	1.6	1.7	2.1	2.4	2.8
47	1.7	1.8	2.4	2.5	3.2
100	1.8	2.0	2.6	3.0	3.6
220	2.2	2.5	3.5	4.0	4.5
330	3.0	3.3	4.0	4.5	5.5
470	3.5	4.0	4.5	5.0	6.0
1000	4.5	5.0	5.5	6.0	8.0
2200	5.5	6.0	6.5	8.0	12.0

### 50V CERAMIC DISC CAPACITORS \$1.00 Per Package

9/pkg 5pf	7/pkg 680pf
9/pkg 15pf	9/pkg .001mfd
9/pkg 25pf	9/pkg .0015mfd
9/pkg 27pf	9/pkg .002mfd
9/pkg 47pf	9/pkg .003mfd
8/pkg 68pf	9/pkg .004mfd
8/pkg 100pf	9/pkg .005mfd
8/pkg 150pf	9/pkg .01mfd
8/pkg 220pf	8/pkg .015mfd
7/pkg 270pf	8/pkg .02mfd
7/pkg 300pf	8/pkg .022mfd
7/pkg 330pf	8/pkg .03mfd
7/pkg 390pf	7/pkg .039mfd
7/pkg 470pf	7/pkg .047mfd
7/pkg 560pf	6/pkg .1mfd

### JAPANESE TRANSISTORS

2SB405	.85	2SC1973	1.30
2SC636	2/1.20	2SC1974	3.00
2SC828	2/1.50	2SC1975	3.10
2SC829	2/1.50	2SC2034	4.00
2SC929	2/1.40	2SD72	1.00
2SC930	2/1.30	2SD313	1.10
2SC933	1.00	2SD325	1.25
2SC1226A	1.25	3K49	2.75
2SC1359	.90		

MN6040 C-MOS PLL - a single-chip phase-locked loop intended for use as a frequency synthesizer in CB transceivers and other communications equipment. \$7.90

### MATSUO DIPPED TANTALUM CAPACITORS

MF V	S	MF V	S
.001	1000	.14	390
.0012	1000	.14	470
.0015	1000	.14	560
.0018	1000	.14	680
.0022	1000	.14	820
.0027	1000	.14	1000
.0033	1000	.14	1200
.0039	1000	.14	1500
.0047	630	.14	1800
.0056	630	.14	2200
.0068	630	.14	2700
.0082	630	.14	3300
.01	630	.14	3900
.012	630	.14	4700
.015	400	.15	5600
.018	400	.15	6800
.022	400	.15	8200
.027	400	.15	10000
.033	250	.15	

### AM1702A-6 ORIGINAL AMD 1.5 MSEC GUARANTEED

1 PIECE - \$ 5.90  
8 PIECES - \$38.00

### SGS-ATES - Audio Power Amplifier IC's

TBA800	5 watt	\$1.95
TBA8105	7 watt	2.10
TBA810AS	7 watt	1.35
TBA820	2 watt	1.95
TBA8305	4.2 watt	1.95
TCA940	10 watt	3.30
TDA2002	8 watt	4.20
TDA2010	12W Hi-Fi	5.25
TDA2020	20W Hi-Fi	6.00

Our Ancrona Information Book 101 contains 92 pgs of data & application notes on using SGS-ATES Audio Amps. Get your copy now. Only \$4.95

### AM1702A-6 ORIGINAL AMD 1.5 MSEC GUARANTEED

1 PIECE - \$ 5.90  
8 PIECES - \$38.00

### SGS-ATES - Audio Power Amplifier IC's

TBA800	5 watt	\$1.95
TBA8105	7 watt	2.10
TBA810AS	7 watt	1.35
TBA820	2 watt	1.95
TBA8305	4.2 watt	1.95
TCA940	10 watt	3.30
TDA2002	8 watt	4.20
TDA2010	12W Hi-Fi	5.25
TDA2020	20W Hi-Fi	6.00

Our Ancrona Information Book 101 contains 92 pgs of data & application notes on using SGS-ATES Audio Amps. Get your copy now. Only \$4.95

### RESISTORS

#### CARBON FILM RESISTORS (5%)

Only in Multiples of 100 pcs per value (ohms)

1/4W ... \$1.69 per 100  
1/2W ... \$1.79 per 100

10	100	10K	100K	1.0M
11	110	1.1K	11K	1.1M
12	120	1.2K	12K	1.2M
13	130	1.3K	13K	1.3M
15	150	1.5K	15K	1.5M
16	160	1.6K	16K	1.6M
18	180	1.8K	18K	1.8M
20	200	2.0K	20K	2.0M
22	220	2.2K	22K	2.2M
24	240	2.4K	24K	2.4M
27	270	2.7K	27K	2.7M
30	300	3.0K	30K	3.0M
33	330	3.3K	33K	3.3M
36	360	3.6K	36K	3.6M
39	390	3.9K	39K	3.9M
43	430	4.3K	43K	4.3M
47	470	4.7K	47K	4.7M
51	510	5.1K	51K	5.1M
56	560	5.6K	56K	5.6M
62	620	6.2K	62K	6.2M
68	680	6.8K	68K	6.8M
75	750	7.5K	75K	7.5M
82	820	8.2K	82K	8.2M
91	910	9.1K	91K	9.1M

### RESISTOR ASSORTMENTS

Each assortment contains 5 pcs each of 10 different values. Values included are shown in (Ohms).

1/4W 5% 150 pcs total \$1.75  
1/2W 5% 150 pcs total \$1.85

Asst. 1:	10, 12, 15, 18, 22, 27, 33, 39, 47, 56 ohm
Asst. 2:	68, 82, 100, 120, 150, 180, 220, 270, 330, 390 ohm
Asst. 3:	470, 560, 680, 820 ohm, 1K, 1.2K, 1.5K, 1.8K, 2.2K, 2.7K
Asst. 4:	3.3K, 3.9K, 4.7K, 5.6K, 6.8K, 8.2K, 10K, 12K, 15K, 18K
Asst. 5:	22K, 27K, 33K, 39K, 47K, 56K, 68K, 82K, 100K, 120K
Asst. 6:	150K, 180K, 220K, 270K, 330K, 390K, 470K, 560K, 680K, 820K

Asst. 7: 1M, 1.2M, 1.5M, 1.8M, 2.2M, 2.7M, 3.3M, 3.9M, 4.7M, 5.6M, (1/2W Assortment No. 7 doesn't include 5.6M)

Asst. 8R: (All seven assortments above)  
1/4W 5% 350 pcs total \$10.95  
1/2W 5% 350 pcs total \$11.55

### INTERSL 8038 PRECISION WAVEFORM GENERATOR & VCO

P/N 8038CCPD \$3.90

### AUDIO POWER AMPLIFIERS 5.5 WATT AN315

Designed for mobile radios, tape players, etc. Easy to use. High Gain - 53 dB (Closed Circuit). \$3.90 ea.

### PLESSEY SL1600 APPLICATIONS MANUAL

Contains 114 pages circuit data, system design and technical data for SL1600 Series Radio Communications Integrated Circuits. \$1.95

### PLESSEY SAMPLER 300 METALIZED CAPACITORS 18 DIFFERENT STD. VALUES \$26.00

### FIRST QUALITY ONLY PREMIUM QUALITY COMPONENTS SETS ANCRONA APART

SN75235N	1.10	MOS - RAM	
SN75238N	1.95	(C=CERAMIC) (P=PLASTIC) (DIP)	
SN75239N	1.50		
SN75235N	2.60		
SN75207N	3.30		
SN75208N	3.30		
DM8820N	2.00		
DM8820AN	2.95		
DM8830N	2.10		
DM8831N	7.50		
DM8832N	7.50		
DS8838N	2.95		
N8T26B	3.10		
33A1PC	1.65		
9602PC	2.90		

2048 BIT E-PROM  
C1702A 13.40  
C1702A-6 4.00

1024x8 BIT E-PROM  
C2708 33.50

### COMPUTER INTERFACE

MH0026CN	2.60	FIFO - MEMORY	
DS0056CN	5.85	2812DC	11.80
DS3063N	4.10	2813DC	19.50
MC1488L	1.90	2841DC	9.50
MC1489L	1.90	2841PC	8.25
MC1489AL	1.95	2812C	6.75
P3212	4.35	3341APC	6.75
P3216	3.90		
P3226	3.90		
DS3604N	6.65		
SN74123N	.95		
SN74LS123N	.49		
SN7422N	2.70		
SN7520N	1.55		
SN7525N	1.40		
SN75107N	1.90		
SN75108BN	1.70		
SN75109N	2.40		
SN75110N	2.40		
SN75234N	1.55		

### SanKen HYBRID AUDIO POWER AMPLIFIERS

- Multi-purpose linear amplifiers for commercial and industrial applications.
- Less than 0.5% harmonic distortion at full power level.
- 1/2 dB response from 20 to 100,000 Hz.
- Single or split (dual) power supply.
- Rugged, compact and lightweight packages.
- Built-in current limiting for SI-1050G and efficient heat radiating construction.

### TYPICAL CONNECTIONS SI-1050G WITH SPLIT SUPPLY

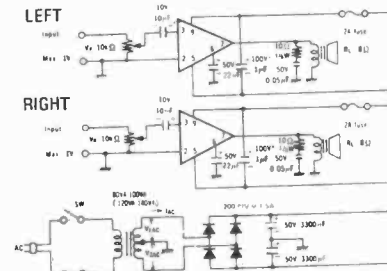

LEFT

RIGHT

### BREADBOARD JUMPER WIRE KIT

Each kit contains 350 wires cut to 14 different lengths from 9"1" to 5"0". Each wire is stripped and leads are bent 90° for easy insertion. Wire length is classified by color coding. All wire is solid tinned 22 gauge with PVC insulation. The wires come packed in a convenient plastic box. BK-1 \$9.95

### SAM'S BOOKS

TTL Cookbook/21035/336 pgs	\$8.95
IC OP-AMP Cookbook/20989/592 pgs	\$12.95
Second Class Radiotelephone License Handbook, 5th Ed./21111/448 pgs	\$7.50
Transistor Substitution Handbook, 16th Ed. 21333/384 pgs	\$4.95
Reference Data for Radio Engineers, 6th Ed. 21218/1344 pgs	\$30.00
Principles and Applications of Electronics Series, Vol. 1: Basic	
Principles and Applications of 20167/320 pgs	\$5.50
Transistor Specifications Manual, 8th Ed. 21335/224 pgs	\$6.95
First Class Radio Telephone License Handbook, 4th Ed./21144/416 pgs	\$7.50
Semiconductor Replacement Guide 21092/256 pgs	\$3.95
Building & Installing Electronic Intrusion Alarms 20929/173 pgs	\$4.50
Understanding IC Operational Amplifiers 20855/128 pgs	\$3.95
How To Use IC Logic Elements, 2nd Ed. H101/160 pgs	\$4.50
Understanding CMOS Integrated Circuits 211929/144 pgs	\$4.95
TV Typewriter Cookbook/21313/256 pgs	\$9.95
CMOS Cookbook/21398/414 pgs	\$9.95

### DIP SOCKETS

LOW PROFILE, SOLDER, TIN

8 Pin	1.15	1.5	1.4
14 Pin	1.9	1.8	1.7
16 Pin	2.1	2.0	1.9
18 Pin	2.8	2.7	2.6
20 Pin	3.4	3.3	3.2
22 Pin	3.6	3.5	3.4
24 Pin	3.7	3.6	3.5
28 Pin	4.4	4.3	4.2
36 Pin	5.9	5.8	5.7
40 Pin	6.2	6.1	6.0

STANDARD SOLDER, TIN

8 Pin	2.5	2.3	2.2
14 Pin	2.7	2.5	2.4
16 Pin	3.0	2.7	2.6
18 Pin	3.5	3.2	3.0
20 Pin	4.0	3.7	3.5
22 Pin	4.0	3.7	3.5
24 Pin	4.9	4.5	4.2
28 Pin	5.9	5.6	5.3
36 Pin	7.5	7.1	6.7
40 Pin	7.5	7.1	6.7

STANDARD SOLDER, GOLD

8 Pin	3.0	2.7	2.4
14 Pin	3.5	3.2	2.9
16 Pin	3.8	3.5	3.2
18 Pin	5.2	4.7	4.3
22 Pin	7.0	6.3	5.7
24 Pin	7.0	6.3	5.7
28 Pin	11.0	10.0	9.0
36 Pin	17.5	16.0	14.5
40 Pin	17.5	15.5	14.0

WIREWRAP GOLD (Level No. 3)

10 Pin	4.1	3.7	3.3
14 Pin	3.9	3.8	3.7
16 Pin	4.3	4.2	4.1
18 Pin	7.5	6.9	6.2
24 Pin	11.0	9.5	8.5
28 Pin	14.0	12.5	11.0
36 Pin	15.9	14.5	13.0
40 Pin	17.5	15.5	14.0

### 2N TRANSISTORS

2N508A	80	2N3568	30	2N4249	18	2N5366	50
2N697	26	2N3569	18	2N4250	24	2N5367	50
2N699	80	2N3570	22	2N4251	24	2N5368	25
2N700	26	2N3571	22	2N4252	37	2N5369	26
2N701	49	2N3572	40	2N4253	37	2N5370	25
2N702	40	2N3573	40	2N4254	37	2N5371	28
2N703	40	2N3574	40	2N4255	37	2N53	

DO-IT-YOURSELF

MODULAR TELEPHONES now available. Sets and components, compatible with Western Electric concept. Catalog 50 cents. Box 1147W, San Diego, California 92112.

TAPE-SLIDE SYNCHRONIZER, lap-dissolve, multiprojector audiovisual plans \$8.50. Free Catalog, Millers, 1896 Maywood, South Euclid, OH 44121.

BUILD Electronic devices in your home. Get started in your spare time. Big Profits — Experience not necessary. Write for free literature telling how. Electronic Development Lab, Dept. D, Box 1535, Pinella Park, FL 33665.

TREASURE FINDERS

SERIOUS COIN SHOOTERS — Semtech's solid-state METU-SENSOR pin-points ALL metal objects, yet defines the target before you dig. FOR FREE literature write Semtech Corporation, 652 Mitchell Rd., Newbury Park, Calif. 91320.

PERSONALS

MAKE FRIENDS WORLDWIDE through International correspondence. Illustrated brochure free. Hermes-Verlag, Box 110660/Z, D-1000 Berlin 11, Germany.

50% ROYALTIES when manufactured. Need designer for digital product. Best design selected. \$2.00 for description and theory. Chris Trehwella, 5B Wendy Lane, Burnt Hills, NY 12027.

HYPNOTISM

SLEEP learning. Hypnotic method. 92% effective. Details free. ASR Foundation, Box 23429EG, Fort Lauderdale, Florida 33307.

FREE Hypnotism. Self-Hypnosis. Sleep Learning Catalog! Drawer H400, Ruidoso, New Mexico 88345.

AMAZING self-hypnosis record releases fantastic mental power. Instant results! Free trial. Write: Forum (AAB), 333 North Michigan, Chicago 60601.

P.O. Box 4430C Santa Clara, CA 95054 (408) 988-1640



Same day shipment. First line parts only. Factory tested. Guaranteed money back. Quality IC's and other components at factory prices.

INTEGRATED CIRCUITS

Table listing various integrated circuits with part numbers, descriptions, and prices.

Table listing various electronic components including resistors, capacitors, diodes, and transistors with prices.

Digital Thermometer \$65.00 General purpose or medical 32°-230°F. Disposable probe cover ±.2° accuracy. Completely assembled w/compact case.

2.5 MHz Frequency Counter Kit As low as 10 Hz .6-.50° digits with PC board and full instructions. \$40.00

Home Alarm Kit \$18.75 Designed for use with electronic siren module. AC power, battery backup, entry/exit delay. Instant alarm for night use. NO/NC circuits. Test and arm indicators. 2 amp switching capability. All parts with complete instructions minus power supply. Electronic siren module kit. \$2.75

Not a Cheap Clock Kit \$17.45 Includes everything except case. 2-PC boards. 6-.50" LED Displays. 5314 clock chip, transformer, all components and full instructions. Same clock kit with .80" displays. \$22.75

Function Module Card Kit Converts any frequency counter into 3 1/2 digit DVM, digital thermometer, pulse & square generator from 10 Hz to 100 kHz. Complete kit minus power supply. \$25.00

Clock Calendar Kit \$29.95 CT7015 direct drive chip displays date and time on 6" LEDs with AM-PM Indicator. Alarm/doze feature includes buzzer. Complete with all parts, power supply and instructions, less case.

Digital Temperature Meter Kit Indoor and outdoor. Automatically switches back and forth. Beautiful. 50° LED readouts. Nothing like it available. Needs no additional parts for complete, full operation. Will measure —100° to +200°F, air or liquid. Very accurate. Complete instructions. \$39.95

Volt/ohm Probe Batt. oper. AC/DC to 125 V. 2 pos. volt. and 2 neg. volt. plus continuity. Stainless steel, pocket size, comp. assem. \$34.95

30 MHz Frequency Counter Kit Crystal time base. Covers audio, amateur and CB band. 6.5" digits, prescalable with PC board and full instructions. \$55.00 Fully wired and tested. \$75.00

Variable Power Supply Kit 0-12 VDC @1/2A, less than .1% line, load regulation. Remote sense capability. Constant voltage/circuit limit can be modified for other V/I ranges. Complete with board and transformers. \$24.00

Stopwatch Kit \$26.95 Full six digit battery operated. 2-.5 volts. 3.2768-MHz crystal accuracy. Times to 59 minutes, 59 seconds, 99 1/100 sec. Times standard, split and Taylor. 7205 chip, all components minus case. Full instructions. White or black plexiglass case. \$5.00

60 Hz Crystal Time Base Kit \$4.75 Converts digital clocks from AC line frequency to crystal time base. Outstanding accuracy. Kit includes: PC board, MMS369, crystal, resistors, and trimmer.

1977 IC Update Master Manual Complete integrated circuit data selector from all manufacturers. 1,234 page master reference guide to the latest IC's including microprocessors and consumer circuits. 17,000 cross references for easier sourcing of hard to get parts. Special pricing: \$24.95, with free update service thru 1977. Domestic postage \$2.00. Foreign \$6.00.

Cosmac 'ELF' Kit RCA CMOS Expandable Microcomputer. New PC board with monitor on PROM included. No hard wiring required. All on board including power supply. Complete kit of parts with assembly users manual. \$109.00 Board only \$14.95. Special case \$15.00

Auto Clock Kit \$15.95 DC clock with 4-.50" displays. Uses National MA1012 module with alarm option. Crystal time base PC boards and full instructions. Add \$3.95 for a beautiful dark gray case ready to install. This is the best value available anywhere!

TERMS: \$5.00 min. order U.S. Funds. Calif residents add 6% (ex. BankAmericard and Master Charge accepted. Shipping charges will be added. FREE: Send for your copy of our 1977 QUEST CATALOG. Include 13¢ stamp.



The ideal way to save your valuable copies, keep them well protected and make it easy for you to refer to any issue at any time. Both decorative and attractive enough to enhance the decor of any room, each case holds a full year's copies. Constructed of reinforced fiberboard, these durable cases are covered in a rich-textured leatherette. The gold embossed back adds to its elegance and makes each case a welcome addition to your bookshelf or cabinet.

Cases are available for your favorite magazines. Only \$5.95 each, 3 for \$15.50 in any combination of titles, including all postage and handling charges. Outside U.S.A. add \$1 per case.

CHARGE YOUR ORDER TO YOUR AMERICAN EXPRESS, BANKAMERICARD, MASTER CHARGE OR DINERS CLUB ACCOUNT.

Ziff-Davis Serv. Div., Dept. JJ, 595 B'way, N.Y. 10012 Please send the Magazine Cases indicated below: TITLE QUANTITY

Form with checkboxes for selecting magazine cases: All Black, Maroon Back, Black Sides, Enclosed is \$, Charge, BankAmericard, Master Charge, PE-B7, American Express, Diners Club, Account #, Exp. Date, Master Charge Interbank #, Signature, Print Name, Address, City, State, Zip, Residents of Calif., Col., Fla., Ill., Mich., Mo., N.Y. State, D.C. and Tex. add applicable sales tax.

MIND-ABSORBING PROJECTS FOR ELECTRONIC EXPERIMENTERS AND HOBBYISTS

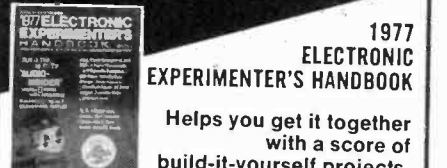

This latest edition includes a host of exciting construction projects for audio buffs—Audio-Controlled Detailed Power Shut Off; 9-Channel Stereo Equalizer... Fun and Games—FLIP, a CMOS Logic Game; Sound Effects with the 555 IC Timer... for experimenter's—ESP Testing Machine; How to Make Double-Sided PC Boards; IC Digital Logic Memory Probe... for computer/calculator enthusiasts—An Under-\$30 Scientific Calculator; Microcomputer Primer; Bits-to-Dots Computer Video. There's a host of other projects including The Executive Digital Temper Countdowner • Versatile Nickel-Cadmium Battery Charger • Shirt-Pocket Metronome • Hall Effect Magnetometer • Low-Cost Metal Locator • 3-Way Photo Flash Tripper • The 99-cent Wonder IC • High-Value Electrolytic Capacitor Meter • Guitar Sound Intensifier • IC Photo Tachometer • R-F Transistor Tester • And more! PLUS: Microcomputer product buying guide and a basic digital logic course. All with complete construction plans, parts lists and printed-circuit board patterns. Many projects are unique designs not available elsewhere. Only \$1.85!

Ziff-Davis Publishing Co. PE-87 Consumer Service Division 595 Broadway, New York, N.Y. 10012 Please send the 1977 ELECTRONIC EXPERIMENTERS' HANDBOOK. I'm enclosing \$1.85 (\$1.50 plus 35¢ for postage and handling). Outside U.S.A. \$3.00, postpaid. Residents of Calif., Col., Fla., Ill., Mich., Mo., N.Y. State, D.C. and Tex. add applicable sales tax (postage and handling charges non-taxable). print name address city state zip

READER SERVICE NO.	ADVERTISER	PAGE NO.
1	A P Products, Inc.	34
2	Ace Electronics	113
3	Active Electronic Sales Corp.	103
4	Advanced Microcomputer Products	104
6	Ancrona Corp.	111
7	Audio-Technica U.S. Inc.	26
7	Avanti Research & Development, Inc.	9
8	B&F Enterprises	94
10	Bullet Electronics	106
11	C B Radio Repair Course, Inc.	90
	CREI Capitol Radio Engineering Institute	60, 61, 62, 63
	Cleveland Institute of Electronics	22, 23, 24, 25
12	Cobra, Product of Dynascan	SECOND COVER
13	Continental Specialties Corporation	5
63	Control & Information Systems, Inc.	76
14	Digi-Key Corporation	105
15	Digital Group, The	38
16	EICO	86
18	Edmund Scientific Co.	114
64	Electra Company	15
19	Empire Scientific Corp.	6
20	Extron LIFESCREEN Projection System	83
21	Fluke	37
22	Godbout Elecs., Bill	108
23	Grantham College of Engineering	86
5	Heath Company	78, 79, 80, 81
24	Illinois Audio	90
25	International Electronics Unlimited	110
26	James Electronics	100, 101
33	Johnson Co., E.F.	FOURTH COVER
67	Kendon Manufacturing	92
34	McIntosh Laboratory Inc.	83
35	M & R Enterprises	12
36	MITS	27
66	Mallory & Co., P.R.	91
37	Motorola	21
38	Motorola Semiconductors	73
	NRI Schools	16, 17, 18, 19
39	New-Tone Electronics	107
62	OK Machine & Tool Corporation	11
40	OK Machine & Tool Corporation	93
41	Olson Electronics	110
42	Optoelectronics	109
43	PAIA Electronics	77
44	Poly Paks	99
45	Quest Electronics	112
46	Radio Hut	95
47	Radio Shack	87
48	Ramsay Electronics	108
49	S.A.E.	10
50	S.D. Sales Co.	96
65	Sabtronics	28
51	Secore	74
52	Shure Brothers Inc.	70
53	Solid State Sales	106
54	Southwest Technical Products Corporation	13
55	Stanton Magnetics, Inc.	THIRD COVER
56	Techni-Tool Inc.	12
57	Tri-Tek, Inc.	75
58	U.S. Pioneer Electronics	2
59	Ungar	1
60	Weller-Xcelite Inc.	70
61	Winthrop-Rogers Ltd.	7

CLASSIFIED ADVERTISING  
94, 102, 104, 106, 108, 110, 112, 113

### MUSICAL INSTRUMENTS

UP TO 60% DISCOUNT. Name brand instruments catalog. Freeport Music, 114 G. Mahan St., W. Babylon, N.Y. 11704.

### INVENTIONS WANTED

INVENTORS: Manufacturers Need New Products. Free "Recommended Procedure," by a creative fee-based invention service company. Washington Inventors Service, 422-T Washington Building, Washington, D. C. 20005.

# INVENTORS

## RECOGNITION...FINANCIAL REWARD...OR CREDIT

FOR "INVENTING IT FIRST" MAY BE YOURS!

If you have an idea for a new product, or a way to make an old product better, contact us, "the idea people." We'll develop your idea, introduce it to industry, negotiate for cash sale or royalty licensing. Write now without cost or obligation for free information. Fees are charged only for contracted services. So send for your FREE "Inventor's Kit." It has important Marketing Information, a special "Invention Record Form" and a Directory of 1001 Corporations Seeking New Products.



**RAYMOND LEE ORGANIZATION**  
230 Park Avenue North, New York, NY 10017  
At no cost or obligation, please rush my FREE "Inventor's Kit No. A-112"

Name \_\_\_\_\_  
Address \_\_\_\_\_  
City \_\_\_\_\_ State \_\_\_\_\_ Zip \_\_\_\_\_  
Phone No. \_\_\_\_\_ Area Code \_\_\_\_\_

FREE PAMPHLET: "Tips on Marketing Your Invention", from an experienced fee-based invention service company. Write: United States Inventors Service Company, Dept. 1435 G Street NW, Washington DC 20005.

### SERVICES

PC BOARDS from your art. Send SASE for info. Assembly Systems, Box 221, Wadsworth, OH 44281.

### HOME ENTERTAINMENT FILMS

1976 Indy "500" — "WHEELS KEEP ROLLING" — is ready! Super 8 Vivid Eastman Color, 200' reel + script, \$19.95 ea. Johnny Miller's "Miracle at Oakmont," a 200' US Open golf film, \$7.95 ea Super 8 B&W; \$18.95 ea Super 8 Color (save a buck). For 400' Super 8 Color Mag Sound, \$44.95 ea (save \$5.00) — limited offer! Guinness World Records now on film — all the sports stars (like Hank Aaron, Mark Spitz) — choice of 3 different volumes, 200' Super 8 Color Sound, \$29.95 ea; 200' Super 8 Color Silent, \$19.95 ea — order No. 1 to start. Add 75 cents postage & handling for each film ordered. Send for Columbia catalog, \$0.85; Universal 8 catalog, \$0.75; Sportlite forms, \$0.35. SPORTLITE, Elect-8, 20 N. Wacker Dr., Chicago, IL 60606.

### EMPLOYMENT OPPORTUNITIES

ELECTRONICS/AVIONICS EMPLOYMENT OPPORTUNITIES. Report on jobs now open. Details FREE. Aviation Employment Information Service, Box 240E, Northport, New York 11768.

OVERSEAS JOBS — FANTASTIC PAY! All Occupations. Computerized Reports — \$2.00. TRANSWORLD, International Airport, Bx 90802-N, Los Angeles, Calif. 90009.

OVERSEAS JOBS! All Occupations! Complete details. Where and how to apply. Latest company lists. Resume tips. \$2.00. Information Services, P.O. Box 3345P, Cocoa, FL 32922.

### REAL ESTATE

BIG...NEW...FREE...FALL CATALOG! Over 2,500 top values coast to coast! UNITED FARM AGENCY, 612-EP, West 47th, Kansas City, MO 64112.

### ACOUSTIC COUPLER

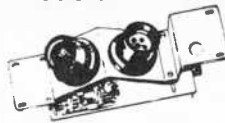

\$47.50

This coupler was manufactured by Novation, Inc. Tazans, California for use in Texas Instruments model 725 Electronic Terminal. It is compatible with Bell 103 and 113 data sets or the equivalent. The coupler operates asynchronously to a maximum speed of 300 baud in the full or half duplex mode. All signal outputs are compatible with TTL. Transmit freq. is 1270Hz for mark and 1070Hz for space. Receive freq. is 2225Hz for mark and 2025Hz for space. Unit requires 112 volts and +5 volts for operation. Complete with schematic and all pertinent information fully reconditioned, calibrated and guaranteed.

\*RS232 to TTL and TTL to RS232 converter kit — \$4.50 (includes P.C. board and schematic)

TMS 5000  
ASCII KEYBOARD  
ENCODER CHIP \$17.95 ZAB010C  
\*ASR 33 Teletype Code (with data)  
\*Data-Ready Pulsed Output  
\*Internal Oscillator  
\*Compatible With Reed And Mechanical Switches  
\*TTL Compatible Inputs And Outputs

PITTMAN 12 VDC MOTOR \$1.95 each  
The Pittman runs on as low as 2 volts, rated 12 volts 250 ma., 2.8 inch oz. torque at 5000RPM. 1 1/8" DIA X 2" long with 0.118" shaft. New, Guaranteed.  
10 for \$15.00

HEWLETT PACKARD 7730 3"char. RED common anode \$1.50 4 for \$5.95  
BISMUTH ALLOY WELTS IN BOILING WATER 1oz. ingot \$3.95 1lb. \$9.95  
EASY TO PLAY WITH!

NE-2H / 43C NEON BULB 100/84.95 1000/839.95  
TEFLON TUBING ASSORTMENT 25/6" LENGTHS VARIOUS SIZES AND COLORS \$1.95

HEAT SHRINK TUBING ASST. 25/6" LENGTHS VARIOUS SIZES AND COLORS \$2.95  
WRITE FOR FREE CATALOG

MOLEX I.C. PINS 100/8.98 1000/86.95  
6" POWER CORDS BLACK OR WHITE 10/\$2.95

KYNAR WIRE WRAP WIRE Solid Silver Plated 30 AWG Available in Blue, Yellow, Black, White, Red, and Green. 100' spool \$2.50, 500' spool \$5.95, 1000' spool \$9.95  
36 AWG Red or Black 500' spool \$7.95 1000' spool \$12.50

MINI KIT  
60HZ. CRYSTAL TIME BASE SPECIAL OFFER ON MINI KIT INCLUDES MMS369 and 3579.545KHZ. CRYSTAL with SCHEMATIC. \$3.95  
4096-BIT low power 400MW. removed from sockets tested and guaranteed. \$9.95/ea. with 22 pin socket and data. B FOR \$64.95

PRINTED CIRCUIT BOARDS G-10 1/16" UNETCHED COPPER CLAD 1oz. 2 SIDED.  
SIZE 1 10 100  
3x6" .50 2.50 19.95  
5x7" .75 4.00 29.95  
4x12" 1.00 5.00 39.95  
SINGLE SIDED SAME PRICE

10K LINEAR POT 1/2" shaft 1" dia. base \$7.50/ea. 10 for \$4.95  
TRIAC G.E. SC51B 15A 200V in prem fit case. Ideal for color organs. 10 FOR \$12.50 \$1.50/ea.

COMPUTER GRADE CAPS 33D POLYPLASTIC 5900MFD-60VDC 10/\$12.50 36D POLYPLASTIC 5000MFD-60VDC 10/\$9.00  
SPECIAL OFFER ON 1N914B 100/\$4.95 1000/\$39.95

MINI 6310  
1392 turns 50mh 65ma 10 for \$2.95  
EAGLE-PICHER CF6V5 6volt 5A.H. spill-proof, rechargeable battery. \$12.50/ea. 10/\$99.95  
NEW—1 YEAR WARRANTY

TERMS: include check or money order. NO COD. Texas residents add 5% sales tax. Canada and Mexico add \$2.50. Overseas countries add \$5.00 for surface rates. We pay postage up to 10 pounds.

CIRCLE NO. 2 ON FREE INFORMATION CARD

### RUBBER STAMPS

RUBBER STAMPS, BUSINESS CARDS. Many new products. Catalog. Jackson's, Dept. K, Brownsville Rd., Mt. Vernon, Ill. 62864.

### BOOKS AND MAGAZINES

FREE book prophet Elijah coming before Christ. Wonderful bible evidence. Megiddo Mission, Dept. 64, 481 Thurston Rd., Rochester, N.Y. 14619.

TECHNICAL MANUALS — Ameco, Arri, Cowan, Gilfer, Rider, RCA Radio Callbook, Sams, Tab. T.I. Postage 35 cents bk, ppd. Five. Madison Electronics, 1508 McKinney, Houston, Texas 77002.

### MISCELLANEOUS

WINEMAKERS: Free illustrated catalog yeasts, equipment. Semplex, Box 12276P, Minneapolis, Minn. 55412.





# The importance of precision in quality control and accurate playback for analysis of sound, are the reasons MCA states... "Stanton is totally reliable, we depend on it" .

Inspecting a metal mother in the Plating Department.

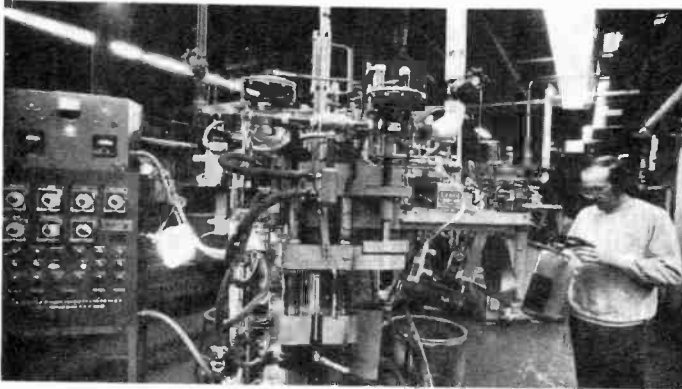

MCA (Music Corporation of America) is one of the truly big ones in record production. Quality control in every aspect of their manufacturing, plating and printing is of crucial importance. That is why they use Stanton's Calibrated 681 Series, both in their quality control operation and in their playback for analysis of audio quality.

They even go so far as to "use the needle to test the Mother (Nickel) . . . and it stands the wear"

Throughout the recording industry, both the large and

the small depend on Stanton for every aspect of the record-producing operation. Each of the 681 Calibration Series is guaranteed to meet its specifications within exacting limits and the most meaningful warranty possible . . . individual calibration test results comes packed with each unit.

Whether your usage involves recording, broadcast, or home entertainment, your choice should be the choice of the professionals . . . the **Stanton 681**.



For further information write to: Stanton Magnetics, Terminal Drive, Plainview, N. Y. 11803

CIRCLE NO. 55 ON FREE INFORMATION CARD



# CLEARLY THE PROFESSIONAL'S CHOICE: JOHNSON CB.



## A 66% lead over the next brand. That's how independent truckers rate Johnson CB.

Independent truckers. The guys who own their own rigs and equip them the way they like because that's "home" as they roll more than 100,000 miles every year. Performance and reliability mean a lot to these professionals.

What kind of CBs do they buy? Johnson... 66% more of them ride with a Johnson CB than the next leading brand, according to a recent survey.\*

And for 1977, we've got a whole new line of 40-channel CBs for truckers, for you and for everybody who's serious about quality. CBs with more features and more value per dollar than ever before.

Exclusive features like our X300D single chip PLL frequency synthesis circuitry for greater

accuracy and reliability. And our exclusive Tapered Automatic Noise Limiter that adjusts itself to changing noise conditions. Or the brightest idea in S/RF meters yet—Johnson's PowerBar LED meter that can be read accurately at a glance from any angle.

Johnson's electronic speech compression gives maximum transmit range and Johnson's voice-tailored audio circuitry delivers quieter, better reception.

Of course, you still get Johnson's solid, made-in-America quality and reliability. Plus the best warranty/service protection in CB—one year on parts and labor with more than 1,000 Authorized Johnson CB Service Centers nationwide.

Johnson CB. Clearly the professional's choice.

\*Independent Trucker Survey results available upon request.



### JOHNSON

PERSONAL COMMUNICATIONS DIVISION  
E. F. JOHNSON COMPANY, CLEAR LAKE, IOWA 50428  
In Canada: A. E. Simmonds & Sons, Ltd.

CIRCLE NO. 33 ON FREE INFORMATION CARD

